

NH Catalogue

Leadership in Circuit Protection

Bussmann is now a part of Eaton

Learn more at [Eaton.com/Cooper](https://www.eaton.com/Cooper)

Bussmann
by **EAT•N**



Leadership in Circuit Protection.

The only company that can provide a complete circuit protection solution for all applications.

Only Eaton can deliver...

- The most diverse solutions to mitigate arc flash energy to keep people and equipment safe
- The smallest and most cost effective way to meet selective coordination requirements
- The most experienced, time-tested solutions to meet national & local code requirements
- The easiest specifications with the most tested fuse/circuit breaker and circuit breaker/circuit breaker series rated combinations
- The only one-stop shop to solve your design challenges using our expertise and an unmatched portfolio

The Eaton advantage.

Powering business worldwide

As a global diversified power management company, we help customers worldwide manage the power needed for buildings, aircraft, trucks, cars, machinery and businesses.

Eaton's innovative technologies help customers manage electrical, hydraulic and mechanical power more reliably, efficiently, safely and sustainably.

We provide integrated solutions that help make energy, in all its forms, more practical and accessible.

With 2012 sales of \$16.3 billion, Eaton has approximately 103,000 employees around the world and sells products in more than 175 countries.

Eaton.com



Powering Business Worldwide

Table of contents

NH Fuse links technical data	4 - 11
Technical data	4 - 6
NH Fuse links applications	7
Features of the NH DIN range	8
Product range overview	9
Ordering key	9
Sizing guide	10
NH Fuse links dimensions - mm	11

400 Volts range - gG	12 - 18
Technical data	12
Part numbers summary	13
Size 000	14
Size 00	15
Sizes 01 and 1	16
Sizes 02 and 2	17
Sizes 03 and 3	18

500 Volts range - gG	19 - 31
Technical data	19
Part numbers summary	20 - 21
Size 000	22
Size 00	23
Size 0	24
Size 01	25
Size 1	26
Size 02	27
Size 2	28
Size 03	29
Size 3	30
Size 4	31

690 Volts range - gG	32 - 39
Technical data	32
Part numbers summary	33
Size 000	34
Size 00	35
Size 1	36
Size 2	37
Size 3	38
Size 4	39

500 and 690 Volts range - aM	40 - 46
Technical data	40
Part numbers summary	41
Size 000	42
Size 00	43
Size 1	44
Size 2	45
Size 3	46

Accessories	47 - 63
NH Fuse bases and accessories	47 - 52
NH Fuse rails - vertical	53 - 55
NH Fuse switch disconnectors - vertical	56 - 58
NH Fuse switch disconnectors - horizontal	59 - 63

Index	64 - 65
--------------	----------------

NH Fuse links technical data

Introduction

Bussmann's NH fuse link range uses the latest technology to provide class leading fuse link performance and reliable indication. With a unique patented dual indicator design capable of operating a microswitch for remote fuse indication, Bussmann provides one of the most reliable solutions available.

The range is fully compliant with IEC 60269-1 and 2 standards, with VDE 0636-2 third party approval and complies with the dimensional requirements of DIN 43620 for ease of use.

In order to help select the correct product for an application, Bussmann provides the following application notes.

Selecting the correct product

Before making a fuse link selection the following information should be known about the system or circuit to be protected.

Type of application (cable protection/motor protection)

For general applications or cable protection, the standard gG (general purpose) NH fuse link should be considered. For Motor protection applications, the aM (motor protection) NH fuse link should be considered. Motor Protection (aM) fuse links have partial range breaking ability and cannot clear low overload faults. They should only be applied to circuits also protected by a motor protection relay or where only high short-circuit faults could occur.

Please note that misapplication of a fuse link can be problematical, consult Bussmann if there is any doubt over fuse link selection.

System voltage

Bussmann's NH fuse links are available in three voltage ratings, 400V, 500V and 690V. These are maximum voltage ratings and should not be used where the nominal system voltage could exceed the fuse link's maximum rating.

Full load current

In accordance with IEC standards, Bussmann's NH fuse links are tested to carry full load current. The rated current of a fuse link should be equal or greater than the operational current of the circuit and equal or smaller than the continuous current carrying capacity of the conductor.

The standard gG (general purpose) NH fuse link with a conventional fusing current of 1.6 times rated current will give assured cable protection against the effects of overcurrents.

Non-fault overload currents (motor inrush currents etc)

To prevent nuisance operation of the fuse link, the fuse link rating selected for the application should take into account any non-fault overload currents. Please refer to the time-current curves in the catalogue.

Possible fault conditions and maximum short-circuit current

This information is essential in order to select the fuse link that would provide the best possible protection under all fault conditions. Bussmann's NH fuse links have a maximum breaking capacity of 120kA and should never be used on a system where the maximum short-circuit current exceeds this level. Please refer to the time-current curves in the catalogue.

NH Fuse links technical data

Time-current curves

The time-current curve is probably the most useful piece of all fuse link data available. It allows you to determine how quickly the fuse link will operate under fault conditions and which fuse link will not operate under non-fault overload currents.

To use the curve simply plot the prospective Root Mean Square (RMS) fault current along the X axis and draw a line vertically upwards from this point. Where this point intersects the fuse curve line, plot a line across to the Y axis for the relevant rating. The Y axis shows the nominal operating time for the fuse in seconds. Hence, it shows how quickly the fuse link will operate under different fault currents.

The graph can be used to check if a fuse link can withstand an overload condition that is not considered to be a fault such as a direct-on-line (DOL) motor start. For example, if a motor starts and the inrush current is six times the full load current for 10 seconds, the exact point can be plotted onto the time-current curve. Any fuse link line lying to the right of this point will withstand the motor start current (allowing for a +/-10% tolerance on each fuse link curve). If the fuse link curve falls to the left of this point, then the fuse link will not withstand the motor start current and will inadvertently operate when the motor is started.

In summary, the rule for time-current curves is that any point on or to the right of a fuse link curve would indicate the fuse link has operated in the given time. Any point to the left of the curve would indicate the fuse link has not operated.

Cut-off curves

The graph consists of an A-B line running diagonally from bottom left to top right, see drawing below. This is known as the non current-limiting line. Branching from this A-B line you can see each individual fuse link rating line running diagonally left to right. To read the graph, plot the RMS prospective fault current along the X axis. If this point only intersects the A-B line then the prospective fault current is too low to benefit from the current-limiting effect of the fuse link.

However, if this point intersects the relevant fuse link line, plot a line across to the Y axis. This point on the Y axis shows the peak asymmetrical let-through current the fuse link will allow to pass before operating. The peak asymmetrical let-through current is the absolute worst case peak current the fuse link will allow to pass through, taking into account the DC offset seen under short-circuit conditions and low power factor.

The RMS let-through current is read from the graph using the same procedure above. Instead of plotting the point of intersection with the fuse link current-limiting line over to the Y axis, it should only be plotted as far as the A-B line. At this point, a line can be drawn back down to the X axis to show a RMS symmetrical value of let-through current. This is known as the “up, over and down method”.

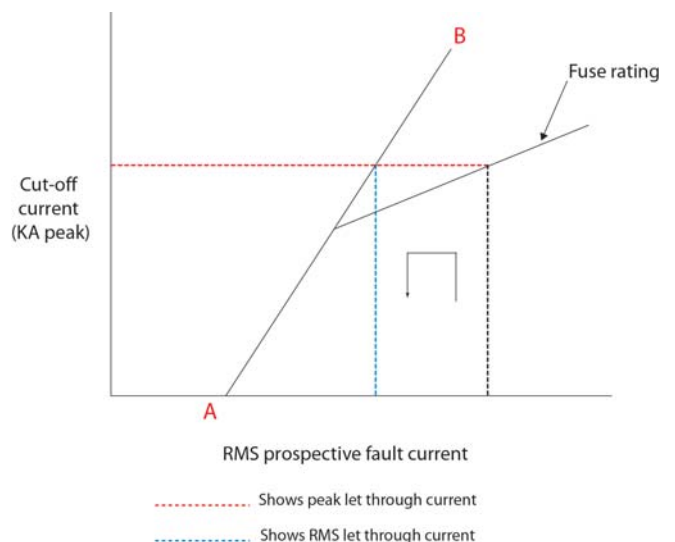

NH Fuse links technical data

I²t values

I²t values are measured at the time of testing the fuse link at their rated breaking capacity and voltage. I²t is effectively the amount of heating energy the fuse link will allow to pass during fault clearing at high short-circuit faults. I²t values relevant for short-circuit faults cannot be calculated from the time-current or cut-off curves. The published I²t figures always show two values, **pre-arcing/total clearing** and are representative of the area under the first half cycle of the fault current.

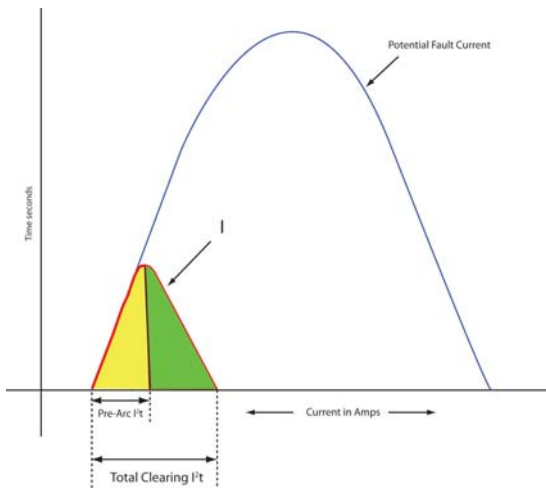

- The **pre-arcing value** is the area under the first half cycle of fault current showing on the graph in yellow to the point just before an arc occurs within the fuse link. This is due to the element material being vaporised by the very high short-circuit current.
- The **total clearing I²t** is the yellow and green area under the first half cycle from the start of the short-circuit current flow to the point where the fuse link has become an insulator, completely isolating the flow of current.

The diagram here shows a representation of I²t during a half cycle of fault current.

I²t values give a good representation of the speed of operation of a fuse link. A small I²t value would indicate a very fast-acting fuse link whereas a large I²t value would indicate a fairly slow operating fuse link. In all cases the total clearing I²t value of the fuse link must be smaller than the I²t value of the device to be protected in order for the fuse link to provide adequate protection against short-circuit faults. For fuse link discrimination (see definition of discrimination below) in distribution systems, the total clearing I²t value of the fuse link downstream should be less than the pre-arcing I²t value of the fuse link upstream. This ensures the smaller fuse link, in the system operates well before the larger upstream fuse link.

NH discrimination

Bussmann's NH fuse links are easy to use on distribution networks where discrimination between large and small fuse links are required. This can be achieved by applying a discrimination factor of 1 to 1.6 without the need to check the fuse link data. For example, by using a 100A fuse link downstream from the main 160A fuse link, in the event of a fault condition, the smaller 100A fuse link is sure to operate before the 160A fuse link, ensuring discrimination.

DC applications

Bussmann's NH fuse links can be used on DC applications. In all cases the fuse links can be used at **half of their AC rating** with a time constant of no more than 10mS. The time constant is the rate of rise of fault current and should be as close to a 50Hz AC half cycle as possible.

Power loss

Every effort is made to ensure the power loss of the fuse link is kept to a minimum. Bussmann provides fuse links with some of the lowest power losses in the industry. Power loss of the fuse link is given off as heat and this should be taken into account when fitting fuse links into unventilated areas. It is preferable that a fuse link has good airflow around the body of the fuse link to ensure cool running and prevent nuisance operation of the fuse link due to thermal stresses.

Should further information be required please contact Bussmann's application engineers: 00 44 (0) 1509 882 699 or buletechnical@eaton.com

NH Fuse links applications



NH fuse links can be found on a solar distribution network



NH fuse links can be found in a wind turbine



NH fuse links can be found on the low voltage side of substations

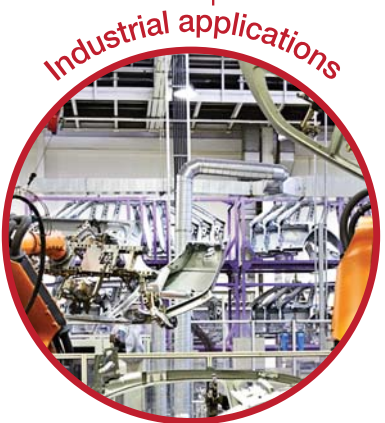

NH fuse links can be used for protection of cables and distribution circuits



NH fuse links can be used for industrial motor applications

NH Dual indicator system from Bussmann

- High breaking capacity
- 400Vac, 500Vac and 690Vac
- Dual indication
- Insulated tag variants option available
- IEC 60269-1 and 2, DIN 43620, VDE 0636-2, CE Mark

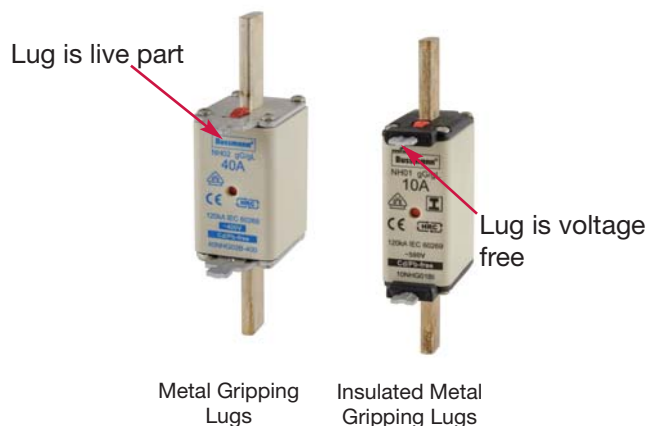

Features of the NH DIN range



Dual indicator system

Bussmann’s patented dual indicator provides clear indication, ensuring extremely reliable local and remote* signalling, decreasing fuse link replacement time and costs.

* with the use of an optional microswitch accessory



Low power loss

Bussmann’s “low watts loss” fuse links reduce overall operating costs and carbon footprint through lower energy consumption and heat transfer to equipment. To find out how much you can save, please contact our technical applications department: buletechnical@eaton.com.



Globally compliant

Bussmann’s NH fuse links are tested and comply with IEC 60269-1 and 2, DIN 43620, VDE, CE, CCC (China), RoHS and can be recycled, ensuring global acceptance.

Cd/Pb-free

Lead and cadmium free

Bussmann is the world’s first true manufacturer of a complete range of Lead and Cadmium free NH fuse links. Negating any legislation concerns regarding the amount of hazardous materials permissible within the fuse links.



Recycling

Bussmann is dedicated to produce recyclable products and is a member of an industry recognised recycling scheme. The “HRC” symbol on Bussmann’s NH fuse links define the product suitable for recycling, limiting disposal cost.

Product range overview

Voltage (Vac)	Class	Size	Amps																						Page														
			2	4	6	10	16	20	25	32	35	40	50	63	80	100	125	160	200	224	250	300	315	355		400	425	450	500	630	800	1000	1250						
400	gG	000	2	4	6	10	16	20	25	32	35	40	50	63	80	100																						14	
		00															125	160																				15	
		01										35	40	50	63	80	100	125	160																			16	
		1																		200	224	250																16	
		02										35	40	50	63	80	100	125	160	200	224	250																17	
		2																								315	355	400				630						17	
		03																				250			315	355	400											18	
		3																													500	630							18
500	gG	000	2	4	6	10	16	20	25	32	35	40	50	63	80	100																					22		
		00											50	63	80	100	125	160																				23	
		0			6	10	16	20	25	32	35	40	50	63	80	100	125	160																				24	
		01			6	10	16	20	25	32	35	40	50	63	80	100	125	160																				25	
		1											50	63	80	100	125	160	200	224	250			315	355													26	
		02										35	40	50	63	80	100	125	160	200	224	250																	27
		2																				250	300	315	355	400	425	450	500									28	
		03																				250			315	355	400											29	
		3																							315	355	400	425	450	500	630	800							30
		4																												500	630	800	1000	1250					31
690	gG	000	2	4	6	10	16	20	25	32	35	40	50	63																							34		
		00											50	63	80	100	125	160																				35	
		1											50	63	80	100	125	160	200	224	250																	36	
		2																		200	224	250			315													37	
		3																				250			315	355	400	425	500									38	
		4																														630	800						39
500 and 690	aM	000			6	10	16	20	25	32	35	40	50																								42		
		00												63	80	100																					43		
		1											50	63	80	100	125	160																				44	
		2															125	160	200	224	250			315	355												45		
		3																							315	355	400		500								46		

■ : Part available, for example Size 00 400V is available in 125 and 160A

Ordering key

Current rating	100					
NH fuse link		NH				
Utilisation class			G			
Body size				000		
Bussmann by Eaton					B	
Insulated metal gripping lugs (optional)						I
Complete part number	100	NH	G	000	B	I

Intuitive part number

Bussmann logical part numbering system provides simple identification of fuse link current, utilisation class, size and voltage, ensuring easy identification on site reducing replacement time and improving network productivity.

Sizing guide

Size 000

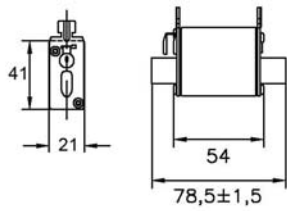

Size 02

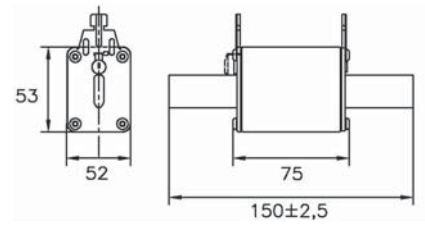

Size 00

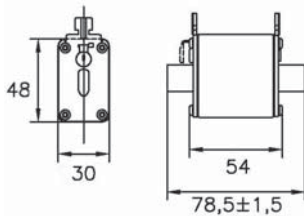

Size 2

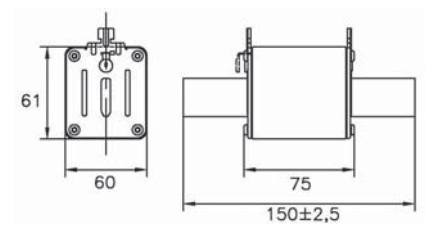

Size 0

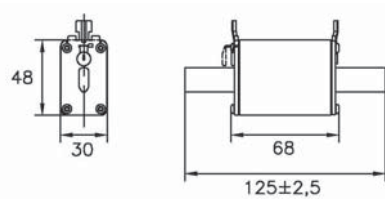

Size 03

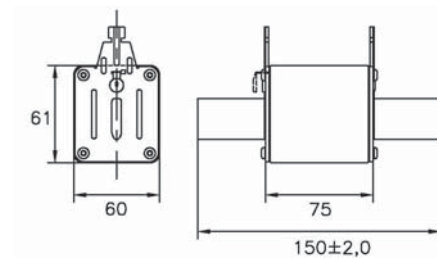

Size 01

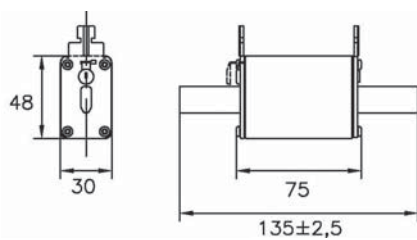

Size 3

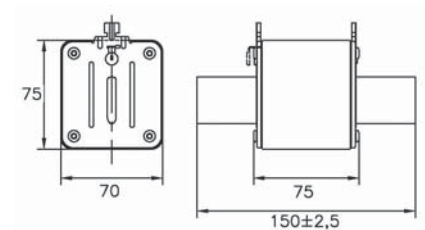

Size 1

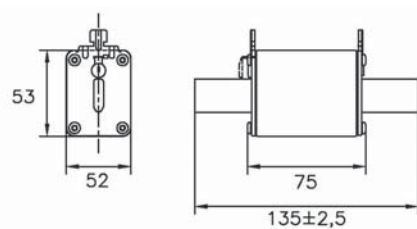

Size 4

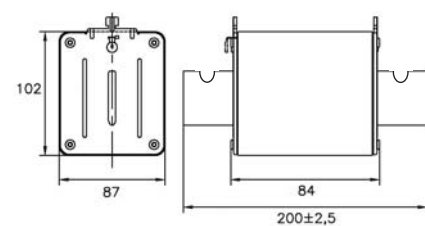

NH Fuse links dimensions - mm

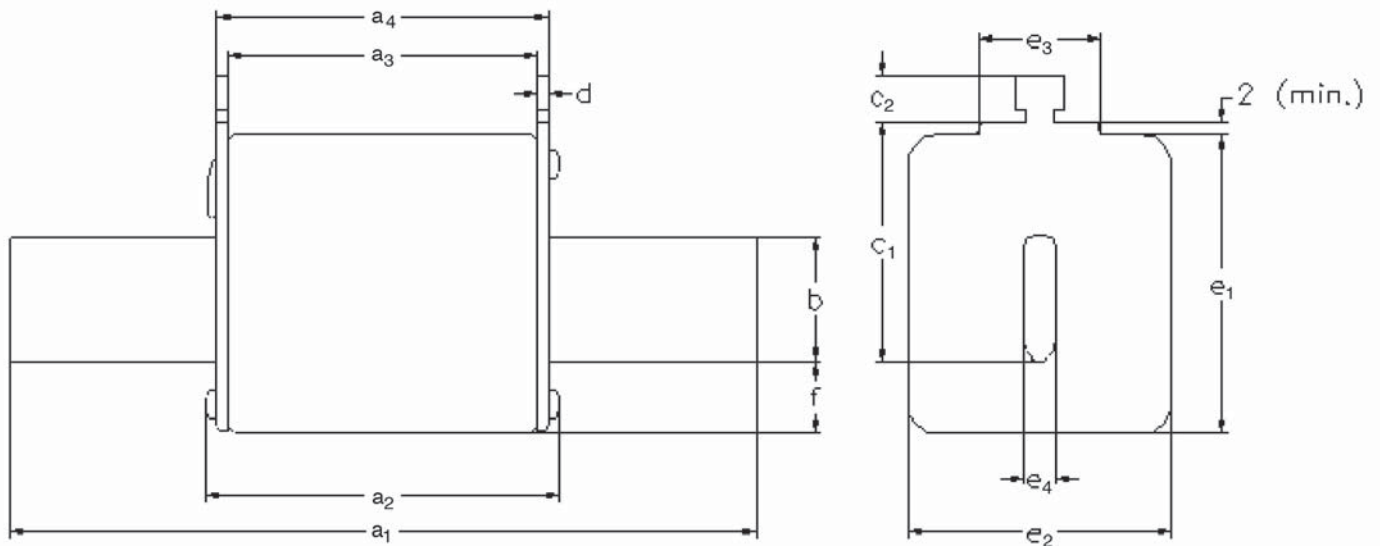

Size	a_1	a_2 (max)	a_3	a_4	b	c_1	c_2	d	e_1 (max)	e_2 (max)	e_3 (max)	e_4	f (max)
000	78.5 ± 1.5	54	45 ± 1.5	49 ± 1.5	15	35	10	2 ± 0.5	41	21	16	6	8
00	78.5 ± 1.5	54	45 ± 1.5	49 ± 1.5	15	35	11	2 ± 0.5	48	30	25	6	15
0	125 ± 2.5	68	$62^{+3}_{-1.5}$	$68^{+1.5}_{-3}$	15	35	11	2.5 ± 0.5	48	30	25	6	15
01	135 ± 2.5	75	62 ± 2.5	68 ± 2.5	15	40	11	2.5 ± 0.5	48	30	25	6	15
1	135 ± 2.5	75	62 ± 2.5	68 ± 2.5	20	40	11	2.5 ± 0.5	53	52	25	6	15
02	150 ± 2.5	75	62 ± 2.5	68 ± 2.5	20	48	11	2.5 ± 0.5	53	52	25	6	15
2	150 ± 2.5	75	62 ± 2.5	68 ± 2.5	25	48	11	2.5 ± 0.5	61	60	25	6	15
03	150 ± 2.5	75	62 ± 2.5	68 ± 2.5	25	60	11	2.5 ± 0.5	61	60	25	6	15
3	150 ± 2.5	75	62 ± 2.5	68 ± 2.5	32	60	11	3 ± 0.5	75	70	25	6	18
4*	200 ± 3	84	62 ± 2.5	90 ± 3	50	85	10	3 ± 0.5	102	87	25	8	30

* Size 4 is a single indication fuse lin with slotted end tags

400Vac class gG/gL - 2 to 630 amps - sizes 000 to 3

400Vac



Description

A square bodied range of industrial fuse links for a wide variety of applications.

Part number structure

(amp)NHG(size)B-400 e.g. 100NHG02B-400

Class of operation: gL/gG

Standards/approvals

IEC 60269-1 and 2, VDE 0636, DIN 43620 and CE

Technical data

- Sizes 000 to 3
- Rated voltage: 400Vac
- Rated current: 2 to 630A
- Rated breaking capacity: 120kA AC
- Rated frequency: 50Hz
- Operating frequency: 45-62Hz

Optional microswitch

- BVL50 or 170H0236

Compatible fuse holders

- Fuse bases: SD(size)-D, SD(size)-S: 1-pole
TD(size)-D, TD(size)-DI: 3-pole
- Fuse bases accessories: IP20, shroud and phase barrier kits
- Fuse rails - vertical: BFR Series
- Fuse switch disconnectors vertical: BFD series
- Fuse switch disconnectors horizontal: BFH series

Environmental:

- Recyclable
- RoHS compliant
- Lead and cadmium free

Packaging: All fuse links are packed in 3's.

Features:

- Reliable dual indicator system
- Low temperature rise
- Globally compliant

Data sheet 720099

400Vac class gG/gL - 2 to 630 amps - sizes 000 to 3

Part numbers

Size	Rated current (Amps)	Rated voltage (Vac)	gG/gL Dual indicator		Pack quantity
			Voltage conducting metal gripping lugs	Insulated metal gripping lugs	
000	2	400	2NHG000B-400	2NHG000BI-400	3
	4		4NHG000B-400	4NHG000BI-400	3
	6		6NHG000B-400	6NHG000BI-400	3
	10		10NHG000B-400	10NHG000BI-400	3
	16		16NHG000B-400	16NHG000BI-400	3
	20		20NHG000B-400	20NHG000BI-400	3
	25		25NHG000B-400	25NHG000BI-400	3
	32		32NHG000B-400	32NHG000BI-400	3
	35		35NHG000B-400	35NHG000BI-400	3
	40		40NHG000B-400	40NHG000BI-400	3
	50		50NHG000B-400	50NHG000BI-400	3
	63		63NHG000B-400	63NHG000BI-400	3
00	80	400	80NHG000B-400	80NHG000BI-400	3
	100		100NHG000B-400	100NHG000BI-400	3
01	125	400	125NHG00B-400	125NHG00BI-400	3
	160		160NHG00B-400	160NHG00BI-400	3
	35		35NHG01B-400	35NHG01BI-400	3
	40		40NHG01B-400	40NHG01BI-400	3
	50		50NHG01B-400	50NHG01BI-400	3
	63		63NHG01B-400	63NHG01BI-400	3
	80		80NHG01B-400	80NHG01BI-400	3
	100		100NHG01B-400	100NHG01BI-400	3
1	125	400	125NHG01B-400	125NHG01BI-400	3
	160		160NHG01B-400	160NHG01BI-400	3
	200		200NHG1B-400	200NHG1BI-400	3
02	224	400	224NHG1B-400	224NHG1BI-400	3
	250		250NHG1B-400	250NHG1BI-400	3
	35		35NHG02B-400	35NHG02BI-400	3
	40		40NHG02B-400	40NHG02BI-400	3
	50		50NHG02B-400	50NHG02BI-400	3
	63		63NHG02B-400	63NHG02BI-400	3
	80		80NHG02B-400	80NHG02BI-400	3
	100		100NHG02B-400	100NHG02BI-400	3
	125		125NHG02B-400	125NHG02BI-400	3
	160		160NHG02B-400	160NHG02BI-400	3
	200		200NHG02B-400	200NHG02BI-400	3
	2		224	400	224NHG02B-400
250		250NHG02B-400	250NHG02BI-400		3
315		315NHG2B-400	315NHG2BI-400		3
355		355NHG2B-400	355NHG2BI-400		3
03	400	400	400NHG2B-400	400NHG2BI-400	3
	630		630NHG2B-400	-	3
	250		250NHG03B-400	250NHG03BI-400	3
	315		315NHG03B-400	315NHG03BI-400	3
3	355	400	355NHG03B-400	355NHG03BI-400	3
	400		400NHG03B-400	400NHG03BI-400	3
	500		500NHG3B-400	500NHG3BI-400	3
	630	400	630NHG3B-400	630NHG3BI-400	3



400Vac

400Vac class gG/gL - 2 to 100 amps - size 000

Time-current characteristics

400Vac

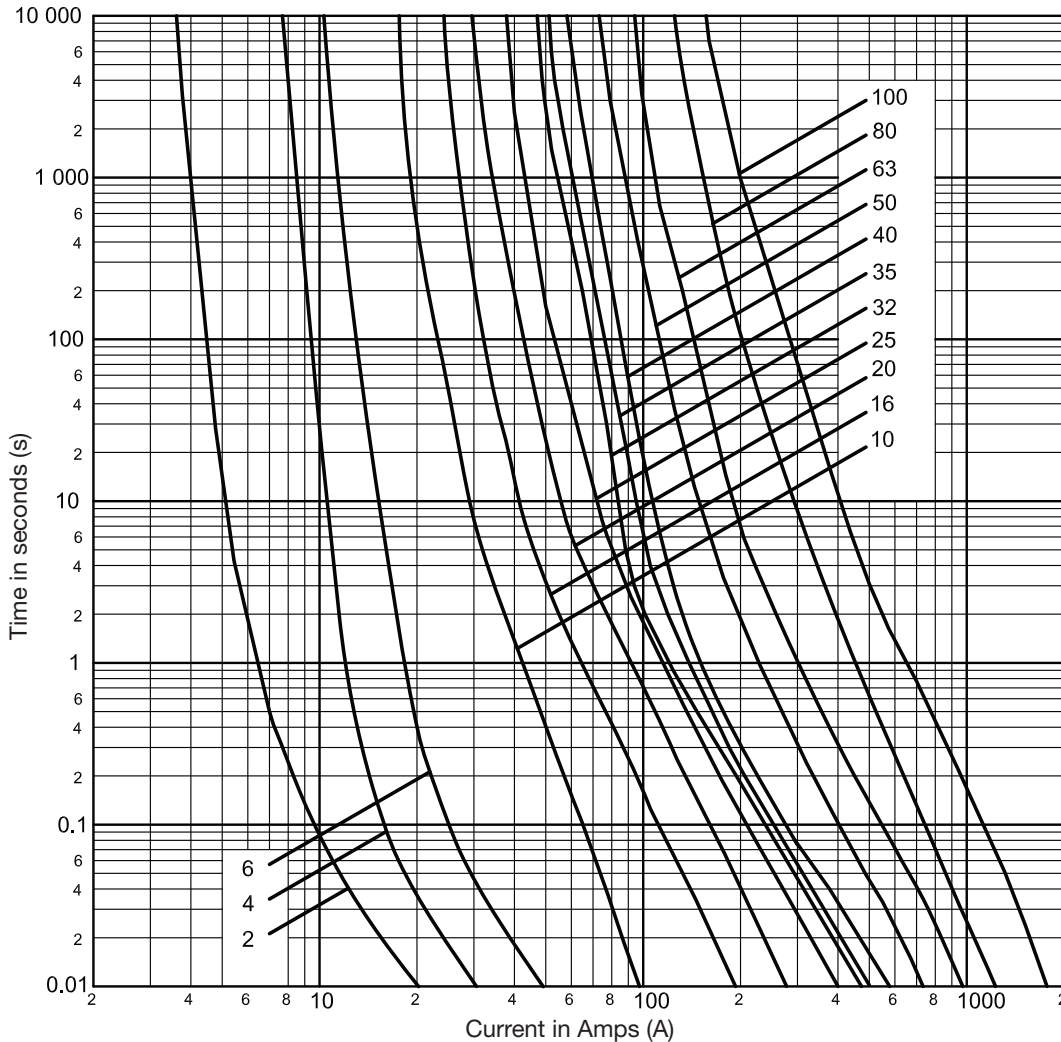

Technical data

Part numbers with metal gripping lugs	Part numbers with insulated metal gripping lugs	Fuse link size	Rated current (Amps)	Rated voltage (Vac)	I ² t (Amps ² Seconds)		Watts loss	Net weight per fuse (Kg)
					Minimum pre-arcing	*I ₁ 120kA at 400Vac		
2NHG000B-400	2NHG000BI-400	000	2	400	3.5	5.5	0.8	0.133
4NHG000B-400	4NHG000BI-400		4		6	10.5	1.4	
6NHG000B-400	6NHG000BI-400		6		14	19	2.2	
10NHG000B-400	10NHG000BI-400		10		60	175	1.5	
16NHG000B-400	16NHG000BI-400		16		240	710	2.3	
20NHG000B-400	20NHG000BI-400		20		584	1800	2.2	
25NHG000B-400	25NHG000BI-400		25		1000	2800	3.1	
32NHG000B-400	32NHG000BI-400		32		2400	9600	2.8	
35NHG000B-400	35NHG000BI-400		35		2900	11,300	2.8	
40NHG000B-400	40NHG000BI-400		40		4000	16,400	3	
50NHG000B-400	50NHG000BI-400		50		4000	12,000	3.4	
63NHG000B-400	63NHG000BI-400		63		6000	20,400	4.5	
80NHG000B-400	80NHG000BI-400		80		9900	35,700	4.7	
100NHG000B-400	100NHG000BI-400		100		18,100	39,800	5.2	

* I₁ is the maximum breaking capacity test at rated voltage according to IEC 60269-1 and 2 requirements

400Vac class gG/gL - 125 and 160 amps - size 00

Time-current characteristics

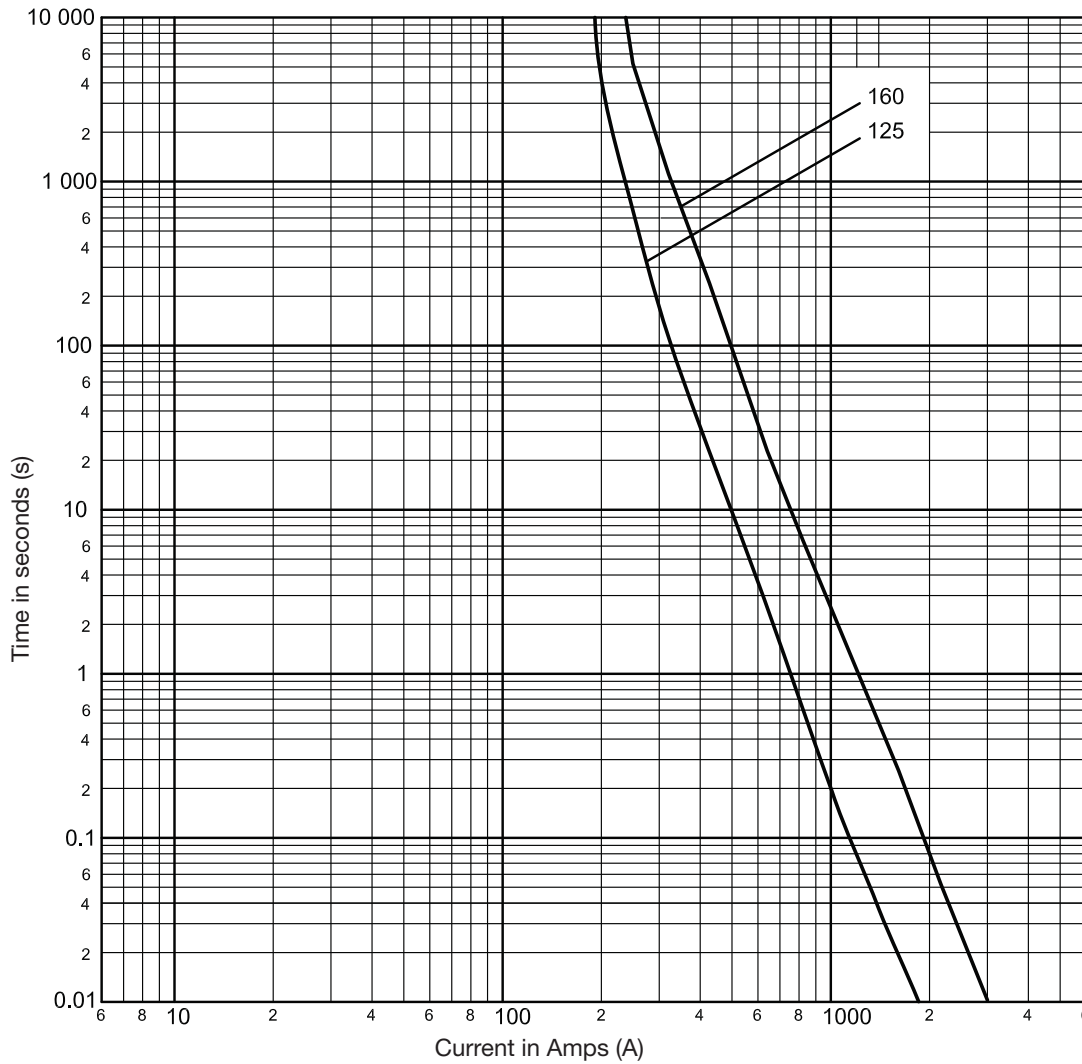

400Vac

Technical data

Part numbers with metal gripping lugs	Part numbers with insulated metal gripping lugs	Fuse link size	Rated current (Amps)	Rated voltage (Vac)	I ² t (Amps ² Seconds)		Watts loss	Net weight per fuse (Kg)
					Minimum pre-arcing	* I ₁ 120kA at 400Vac		
125NHG00B-400	125NHG00BI-400	00	125	400	25,000	80,000	8	0.185
160NHG00B-400	160NHG00BI-400		160		60,000	126,000	7.8	

* I₁ is the maximum breaking capacity test at rated voltage according to IEC 60269-1 and 2 requirements

400Vac class gG/gL - 35 to 250 amps - sizes 01 & 1

Time-current characteristics

400Vac

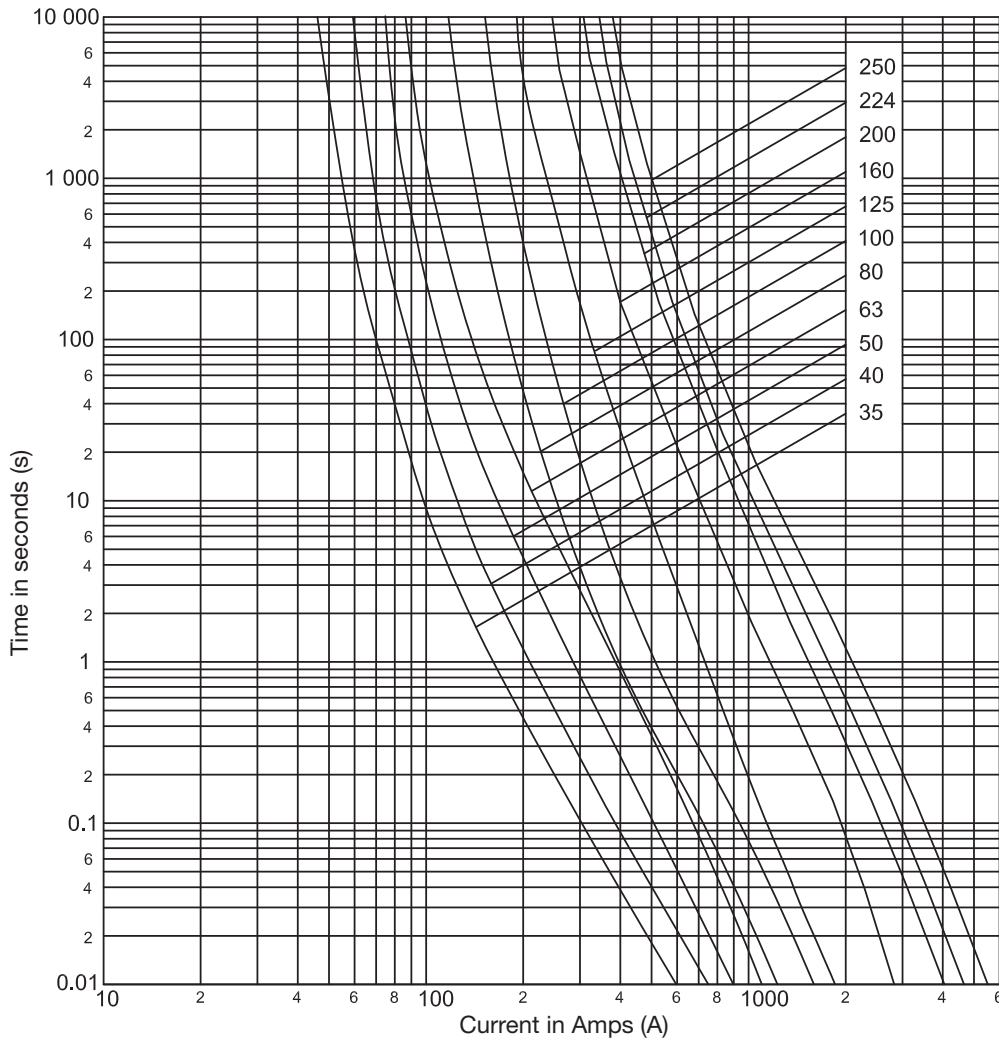

Technical data

Part numbers with metal gripping lugs	Part numbers with insulated metal gripping lugs	Fuse link size	Rated current (Amps)	Rated voltage (Vac)	I ² t (Amps ² Seconds)		Watts loss	Net weight per fuse (Kg)
					Minimum pre-arcing	*I ₁ 120kA at 400Vac		
35NHG01B-400	35NHG01BI-400	01	35	400	2400	7600	4.9	0.269
40NHG01B-400	40NHG01BI-400		40		3300	10,600	5	
50NHG01B-400	50NHG01BI-400		50		4200	10,400	4.7	
63NHG01B-400	63NHG01BI-400		63		6600	16,300	5.6	
80NHG01B-400	80NHG01BI-400		80		9600	33,600	5.6	
100NHG01B-400	100NHG01BI-400		100		16,000	56,000	6.8	
125NHG01B-400	125NHG01BI-400		125		24,000	86,400	8.8	
160NHG01B-400	160NHG01BI-400		160		53,000	111,300	8.9	
200NHG1B-400	200NHG1BI-400	1	200	400	89,000	232,000	12	0.387kg
224NHG1B-400	224NHG1BI-400		224		119,000	322,000	12	
250NHG1B-400	250NHG1BI-400		250		171,000	479,000	14	

* I₁ is the maximum breaking capacity test at rated voltage according to IEC 60269-1 and 2 requirements

400Vac class gG/gL - 35 to 630 amps - sizes 02 & 2

Time-current characteristics

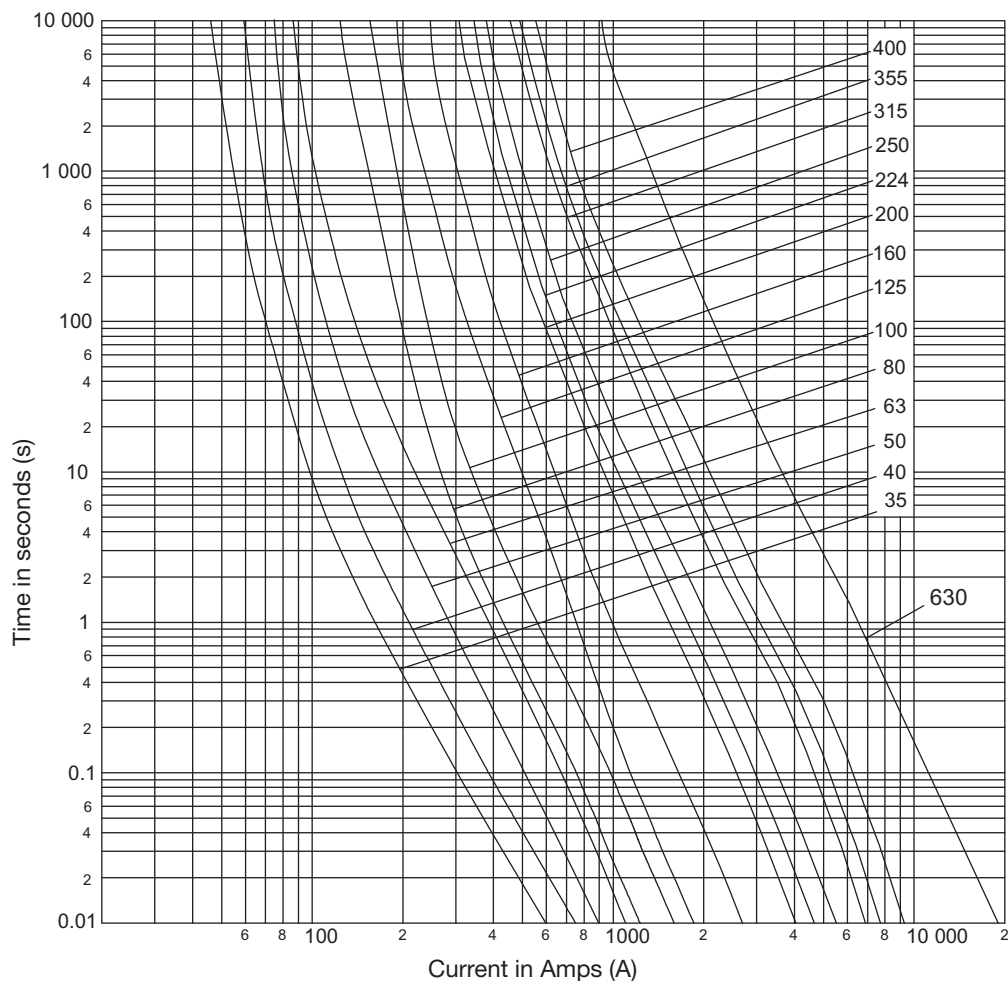

Technical data

Part numbers with metal gripping lugs	Part numbers with insulated metal gripping lugs	Fuse link size	Rated current (Amps)	Rated voltage (Vac)	I ² t (Amps ² Seconds)		Watts loss	Net weight per fuse (Kg)
					Minimum pre-arcing	*I ₁ 120kA at 400Vac		
35NHG02B-400	35NHG02BI-400	02	35	400	2400	7600	4.4	0.402
40NHG02B-400	40NHG02BI-400		40		3300	10,600	5	
50NHG02B-400	50NHG02BI-400		50		4200	10,400	6.5	
63NHG02B-400	63NHG02BI-400		63		6600	16,300	5.5	
80NHG02B-400	80NHG02BI-400		80		10,000	34,800	5.5	
100NHG02B-400	100NHG02BI-400		100		16,000	56,000	6.6	
125NHG02B-400	125NHG02BI-400		125		24,000	86,400	8.7	
160NHG02B-400	160NHG02BI-400		160		50,000	185,000	10	
200NHG02B-400	200NHG02BI-400		200		89,000	232,000	12	
224NHG02B-400	224NHG02BI-400		224		119,000	322,000	12	
250NHG02B-400	250NHG02BI-400		250		171,000	479,000	14	
315NHG2B-400	315NHG2BI-400		315		280,000	924,000	19	
355NHG2B-400	355NHG2BI-400		355		350,000	1,155,000	22	
400NHG2B-400	400NHG2BI-400		400		504,000	1,673,000	24	
630NHG2B-400	-	630	2,100,000	5,775,000	44	0.630kg		

* I₁ is the maximum breaking capacity test at rated voltage according to IEC 60269-1 and 2 requirements

400Vac class gG/gL - 250 to 630 amps - sizes 03 & 3

Time-current characteristics

400Vac

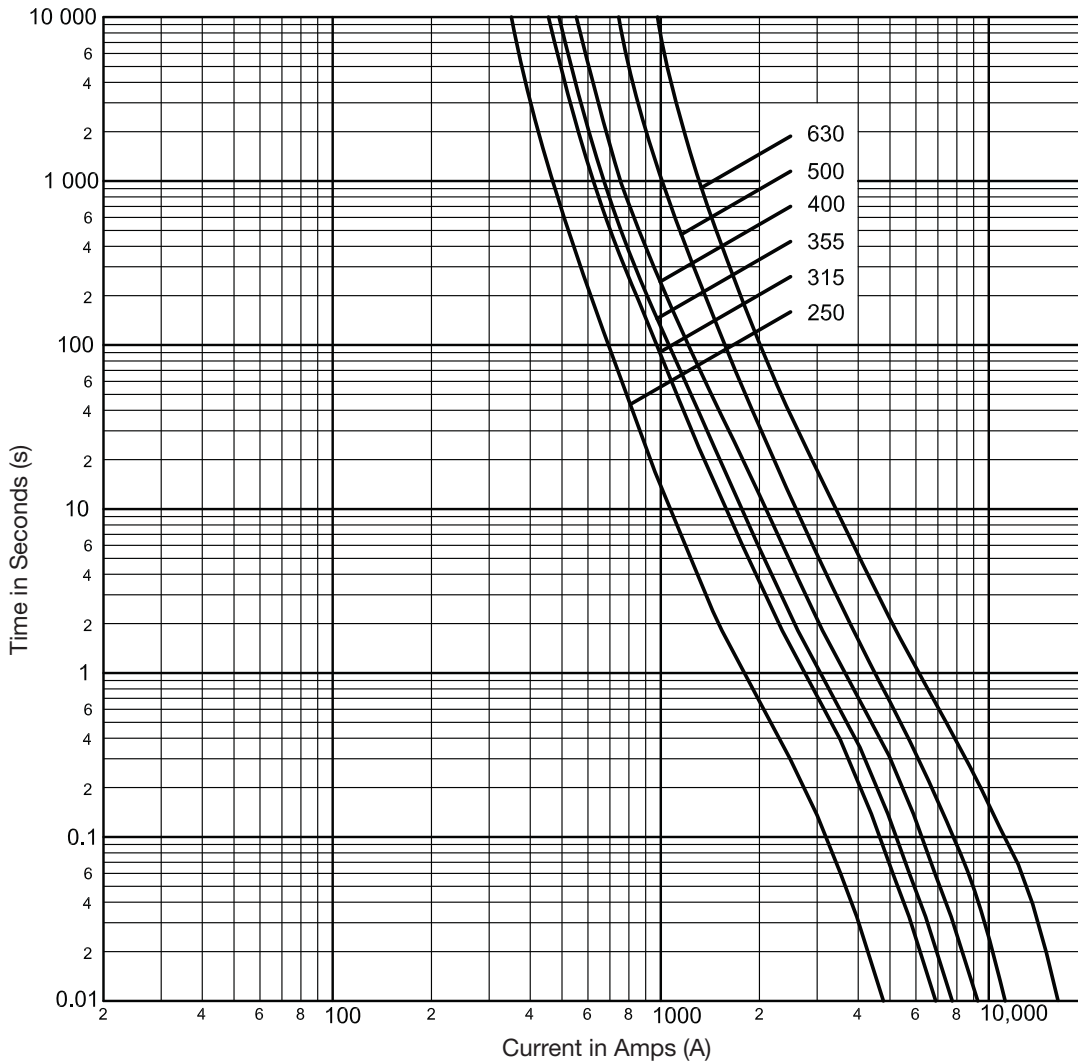

Technical data

Part numbers with metal gripping lugs	Part numbers with insulated metal gripping lugs	Fuse link size	Rated current (Amps)	Rated voltage (Vac)	I ² t (Amps ² Seconds)		Watts loss	Net weight per Fuse (Kg)
					Minimum pre-arcing	*I ₁ 120kA at 400Vac		
250NHG03B-400	250NHG03BI-400	03	250	400	115,000	379,500	18	0.634
315NHG03B-400	315NHG03BI-400		315		280,000	924,000	19	
355NHG03B-400	355NHG03BI-400		355		350,000	1,155,000	22	
400NHG03B-400	400NHG03BI-400		400		504,000	1,663,000	24	
500NHG3B-400	500NHG3BI-400	3	500	400	686,000	2,605,000	30	1.043
630NHG3B-400	630NHG3BI-400		630		1,590,000	6,201,000	36	

* I₁ is the maximum breaking capacity test at rated voltage according to IEC 60269-1 and 2 requirements

500Vac class gG/gL - 2 to 1250 amps - sizes 000 to 4



Description

A square bodied range of industrial fuse links for a wide variety of applications.

Part number structure

(amp)NHG(size)B e.g. 100NHG01B

Class of operation: gL/gG

Standards/approvals

IEC 60269-1 and 2, VDE 0636, DIN 43620 and CE

Technical data

- Sizes 000 to 4
- Rated voltage: 500Vac
- Rated current: 2 to 1250A
- Rated breaking capacity: 120kA AC
- Operating frequency: 45-62Hz

Optional microswitch

- BVL50 or 170H0236

Compatible fuse holders

- Fuse bases: SD(size)-D, SD(size)-S: 1-pole
TD(size)-D, TD(size)-DI: 3-pole
- Fuse bases accessories: IP20, shroud and phase barrier kits
- Fuse rails - vertical: BFR series
- Fuse switch disconnectors vertical: BFD series
- Fuse switch disconnectors horizontal: BFH series

Environmental:

- Recyclable
- RoHS compliant
- Lead and cadmium free

Packaging:

Size 000 to 3: 3 in a pack / Size 4: 1 in a pack

Features:

- Reliable dual indicator system (size 4 single indication only)
- Low temperature rise
- Globally compliant

Data sheet 10164

500Vac class gG/gL - 2 to 1250 amps - sizes 000 to 4

Part numbers - sizes 000 to 01

Size	Rated current (Amps)	Rated voltage (Vac)	gG/gL dual indicator		Pack quantity
			Voltage conducting metal gripping lugs	Insulated metal gripping lugs	
000	2	500	2NHG000B	2NHG000BI	3
	4		4NHG000B	4NHG000BI	3
	6		6NHG000B	6NHG000BI	3
	10		10NHG000B	10NHG000BI	3
	16		16NHG000B	16NHG000BI	3
	20		20NHG000B	20NHG000BI	3
	25		25NHG000B	25NHG000BI	3
	32		32NHG000B	32NHG000BI	3
	35		35NHG000B	35NHG000BI	3
	40		40NHG000B	40NHG000BI	3
	50		50NHG000B	50NHG000BI	3
	63		63NHG000B	63NHG000BI	3
	80		80NHG000B	80NHG000BI	3
100	100NHG000B	100NHG000BI	3		
00	50	500	50NHG00B	50NHG00BI	3
	63		63NHG00B	63NHG00BI	3
	80		80NHG00B	80NHG00BI	3
	100		100NHG00B	100NHG00BI	3
	125		125NHG00B	125NHG00BI	3
	160		160NHG00B	160NHG00BI	3
0	6	500	6NHG0B	6NHG0BI	3
	10		10NHG0B	10NHG0BI	3
	16		16NHG0B	16NHG0BI	3
	20		20NHG0B	20NHG0BI	3
	25		25NHG0B	25NHG0BI	3
	32		32NHG0B	32NHG0BI	3
	35		35NHG0B	35NHG0BI	3
	40		40NHG0B	40NHG0BI	3
	50		50NHG0B	50NHG0BI	3
	63		63NHG0B	63NHG0BI	3
	80		80NHG0B	80NHG0BI	3
	100		100NHG0B	100NHG0BI	3
	125		125NHG0B	125NHG0BI	3
160	160NHG0B	160NHG0BI	3		
01	6	500	6NHG01B	6NHG01BI	3
	10		10NHG01B	10NHG01BI	3
	16		16NHG01B	16NHG01BI	3
	20		20NHG01B	20NHG01BI	3
	25		25NHG01B	25NHG01BI	3
	32		32NHG01B	32NHG01BI	3
	35		35NHG01B	35NHG01BI	3
	40		40NHG01B	40NHG01BI	3
	50		50NHG01B	50NHG01BI	3
	63		63NHG01B	63NHG01BI	3
	80		80NHG01B	80NHG01BI	3
	100		100NHG01B	100NHG01BI	3
	125		125NHG01B	125NHG01BI	3
160	160NHG01B	160NHG01BI	3		

500Vac



500Vac class gG/gL - 2 to 1250 amps - sizes 000 to 4

Part numbers - sizes 1 to 4

Size	Rated current (Amps)	Rated voltage (Vac)	gG/gL dual indicator		Pack quantity
			Voltage conducting metal gripping lugs	Insulated metal gripping lugs	
1	50	500	50NHG1B	50NHG1BI	3
	63		63NHG1B	63NHG1BI	3
	80		80NHG1B	80NHG1BI	3
	100		100NHG1B	100NHG1BI	3
	125		125NHG1B	125NHG1BI	3
	160		160NHG1B	160NHG1BI	3
	200		200NHG1B	200NHG1BI	3
	224		224NHG1B	224NHG1BI	3
	250		250NHG1B	250NHG1BI	3
	315		440	315NHG1B	315NHG1BI
355	355NHG1B	355NHG1BI		3	
02	35	500	35NHG02B	35NHG02BI	3
	40		40NHG02B	40NHG02BI	3
	50		50NHG02B	50NHG02BI	3
	63		63NHG02B	63NHG02BI	3
	80		80NHG02B	80NHG02BI	3
	100		100NHG02B	100NHG02BI	3
	125		125NHG02B	125NHG02BI	3
	160		160NHG02B	160NHG02BI	3
	200		200NHG02B	200NHG02BI	3
	224		224NHG02B	224NHG02BI	3
2	250	500	250NHG2B	250NHG2BI	3
	300		300NHG2B	300NHG2BI	3
	315		315NHG2B	315NHG2BI	3
	355		355NHG2B	355NHG2BI	3
	400		400NHG2B	400NHG2BI	3
	425		425NHG2B	425NHG2BI	3
	450		450NHG2B	450NHG2BI	3
	500		440	500NHG2B	500NHG2BI
03	250	500	250NHG03B	250NHG03BI	3
	315		315NHG03B	315NHG03BI	3
	355		355NHG03B	355NHG03BI	3
	400		400NHG03B	400NHG03BI	3
3	315	500	315NHG3B	-	3
	355		355NHG3B	-	3
	400		400NHG3B	-	3
	425		425NHG3B	-	3
	500		500NHG3B	-	3
	630		630NHG3B	-	3
4*	800	440	800NHG3B	-	3
	500	500	500NHG4G	-	1
	630		630NHG4G	-	1
	800		800NHG4G	-	1
	1000		1000NHG4G	-	1
1250	1250NHG4G		-	1	

* Size 4 NH is a single indication fuse with slotted end tags



500Vac

500Vac class gG/gL - 2 to 100 amps - size 000

Time-current characteristics

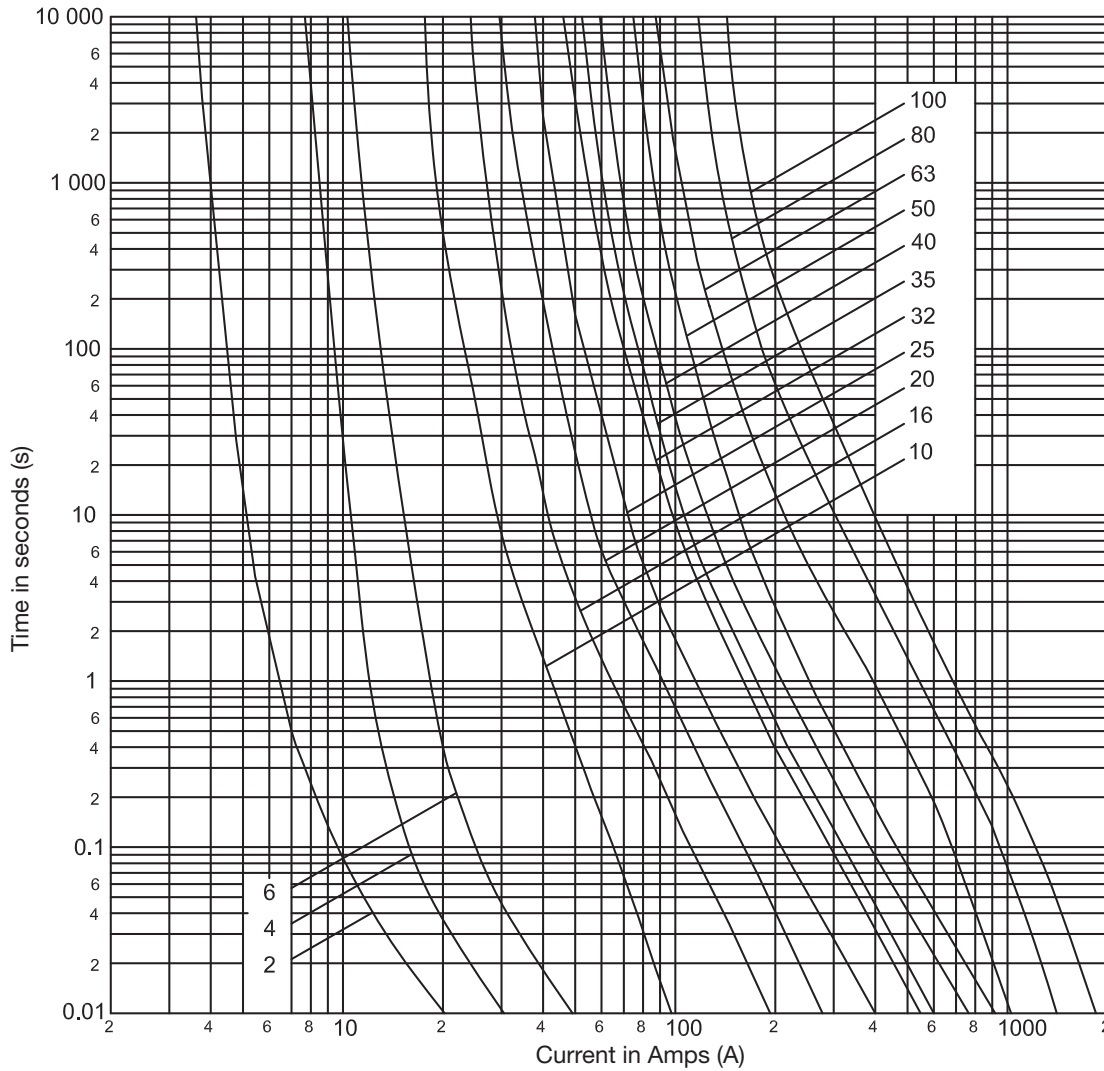

Technical data

Part numbers with metal gripping lugs	Part numbers with insulated metal gripping lugs	Fuse link size	Rated current (Amps)	Rated voltage (Vac)	I ² t (Amps ² Seconds)		Watts loss	Net weight per fuse (Kg)
					Minimum pre-arcing	*I ₁ 120kA at 500Vac		
2NHG000B	2NHG000BI	000	2	500	3.5	6	3.9	0.13
4NHG000B	4NHG000BI		4		6	12	1.8	
6NHG000B	6NHG000BI		6		14	21	2	
10NHG000B	10NHG000BI		10		58	290	1.5	
16NHG000B	16NHG000BI		16		234	1200	2.3	
20NHG000B	20NHG000BI		20		490	2500	2.2	
25NHG000B	25NHG000BI		25		920	4600	3.1	
32NHG000B	32NHG000BI		32		1800	9000	3.4	
35NHG000B	35NHG000BI		35		2400	11,800	3.7	
40NHG000B	40NHG000BI		40		3300	16,500	4	
50NHG000B	50NHG000BI		50		5900	29,500	4.9	
63NHG000B	63NHG000BI		63		6300	24,900	4.6	
80NHG000B	80NHG000BI		80		9800	38,900	6.3	
100NHG000B	100NHG000BI		100		18,100	72,300	7.4	

* I₁ is the maximum breaking capacity test at rated voltage according to IEC 60269-1 and 2 requirements

500Vac class gG/gL - 50 to 160 amps - size 00

Time-current characteristics

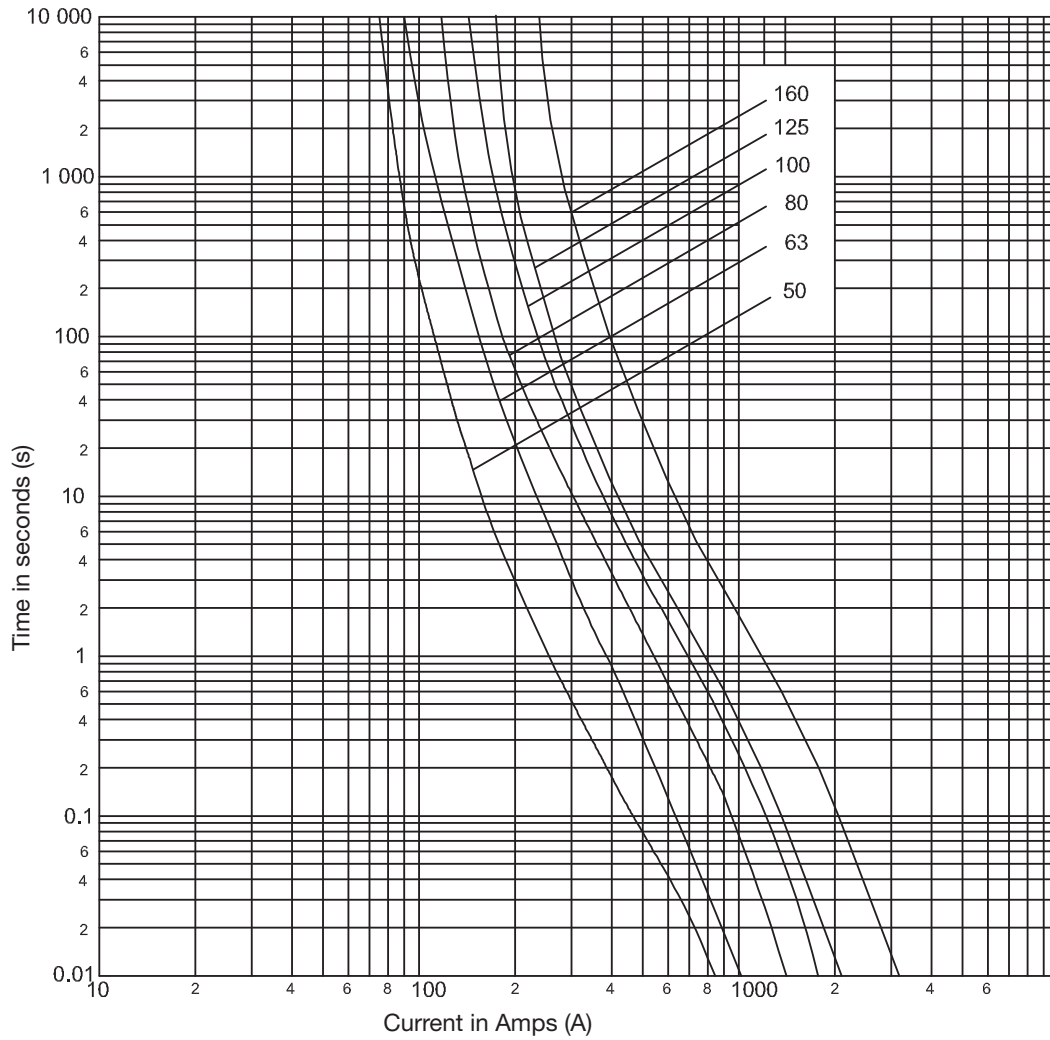

500Vac

Technical data

Part numbers with metal gripping lugs	Part numbers with insulated metal gripping lugs	Fuse link size	Rated current (Amps)	Rated voltage (Vac)	I ² t (Amps ² Seconds)		Watts loss	Net weight per fuse (Kg)
					Minimum pre-arcing	*I ₁ 120kA at 500Vac		
50NHG00B	50NHG00BI	00	50	500	5800	21,500	5	0.190
63NHG00B	63NHG00BI		63		5800	25,000	5	
80NHG00B	80NHG00BI		80		11,000	35,000	7	
100NHG00B	100NHG00BI		100		19,000	60,000	7.5	
125NHG00B	125NHG00BI		125		25,000	125,000	10	
160NHG00B	160NHG00BI		160		64,000	310,000	10	

* I₁ is the maximum breaking capacity test at rated voltage according to IEC 60269-1 and 2 requirements

500Vac class gG/gL - 6 to 160 amps - size 0

Time-current characteristics

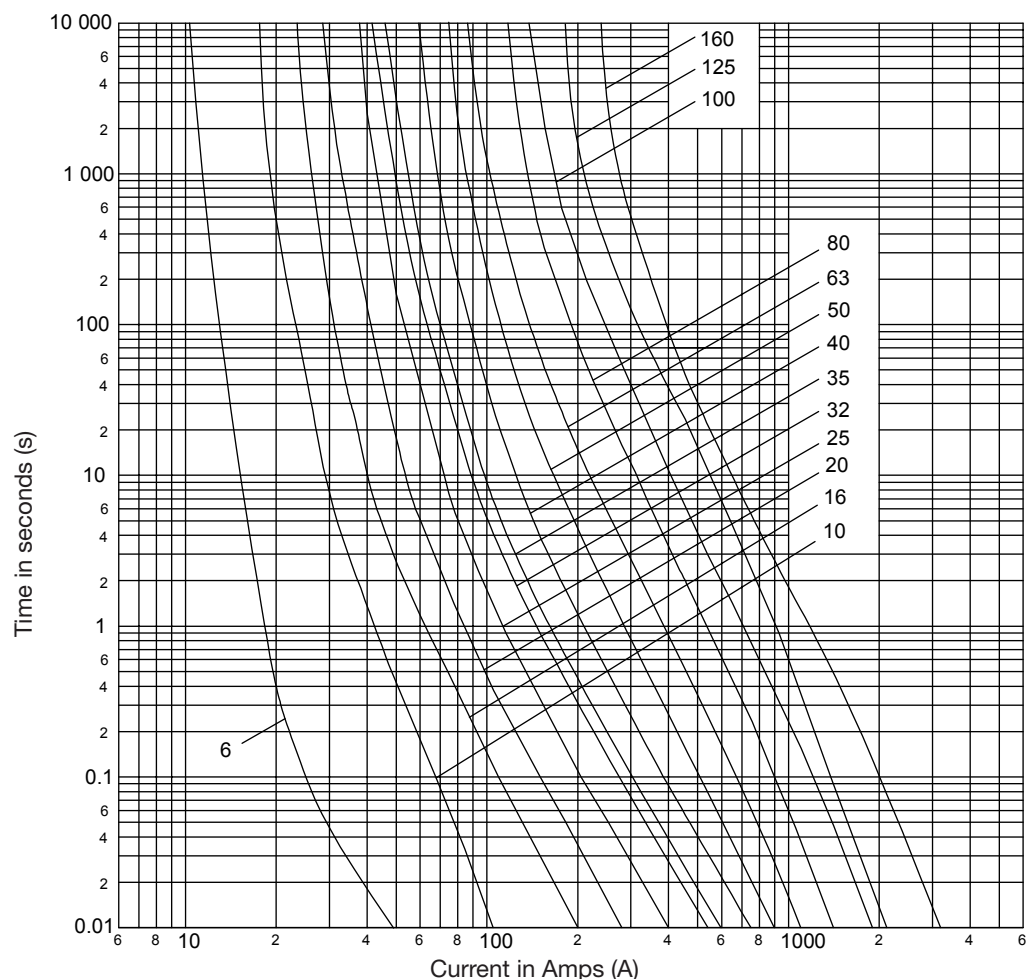

Technical data

Part numbers with metal gripping lugs	Part numbers with insulated metal gripping lugs	Fuse link size	Rated current (Amps)	Rated voltage (Vac)	I ² t (Amps ² Seconds)		Watts loss	Net weight per fuse (Kg)
					Minimum pre-arcing	*I ₁ 120kA at 500Vac		
6NHG0B	6NHG0BI	0	6	500	14	21	2	0.26
10NHG0B	10NHG0BI		10		58	290	2	
16NHG0B	16NHG0BI		16		240	1200	3	
20NHG0B	20NHG0BI		20		490	2500	3.5	
25NHG0B	25NHG0BI		25		1200	5600	3.2	
32NHG0B	32NHG0BI		32		1800	9000	4.8	
35NHG0B	35NHG0BI		35		2400	11,800	4.7	
40NHG0B	40NHG0BI		40		3300	16,500	5	
50NHG0B	50NHG0BI		50		5600	27,800	6.3	
63NHG0B	63NHG0BI		63		6600	26,100	5.6	
80NHG0B	80NHG0BI		80		9800	38,900	7.1	
100NHG0B	100NHG0BI		100		20,600	82,300	7.5	
125NHG0B	125NHG0BI		125		25,000	125,000	11.8	
160NHG0B	160NHG0BI		160		62,000	310,000	12.3	

* I₁ is the maximum breaking capacity test at rated voltage according to IEC 60269-1 and 2 requirements

500Vac class gG/gL - 6 to 160 amps - size 01

Time-current characteristics

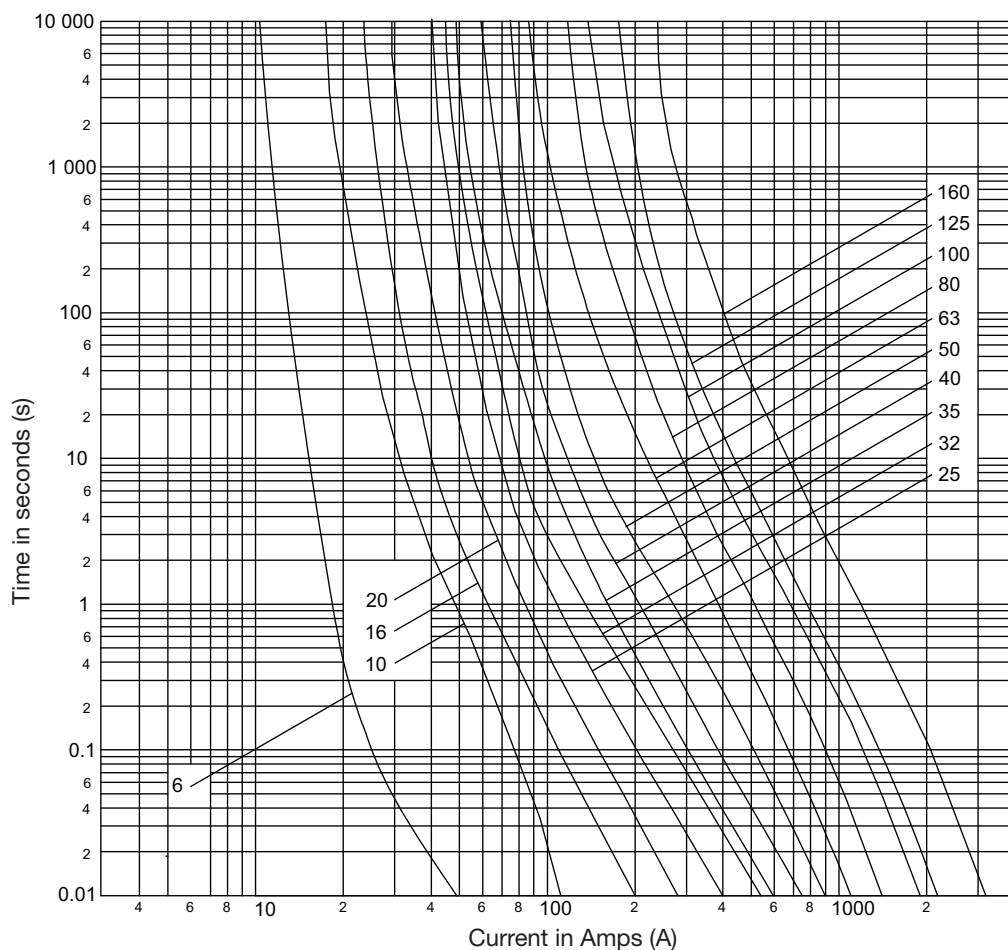

Technical data

Part numbers with metal gripping lugs	Part numbers with insulated metal gripping lugs	Fuse link size	Rated current (Amps)	Rated voltage (Vac)	I ² t (Amps ² Seconds)		Watts loss	Net weight per fuse (Kg)
					Minimum pre-arcing	*I ₁ 120kA at 500Vac		
6NHG01B	6NHG01BI	01	6	500	14	21	2	0.27
10NHG01B	10NHG01BI		10		58	290	2	
16NHG01B	16NHG01BI		16		240	1200	3	
20NHG01B	20NHG01BI		20		490	2500	3.4	
25NHG01B	25NHG01BI		25		1200	5600	5	
32NHG01B	32NHG01BI		32		1800	9000	4.8	
35NHG01B	35NHG01BI		35		2400	11,800	4.6	
40NHG01B	40NHG01BI		40		3300	16,500	5	
50NHG01B	50NHG01BI		50		5600	27,800	6.3	
63NHG01B	63NHG01BI		63		6600	26,100	5.6	
80NHG01B	80NHG01BI		80		9800	38,900	7.1	
100NHG01B	100NHG01BI		100		20,600	82,300	7.7	
125NHG01B	125NHG01BI		125		25,000	125,000	11.8	
160NHG01B	160NHG01BI		160		62,000	310,000	12.3	

* I₁ is the maximum breaking capacity test at rated voltage according to IEC 60269-1 and 2 requirements

500Vac class gG/gL - 50 to 355 amps - size 1

Time-current characteristics

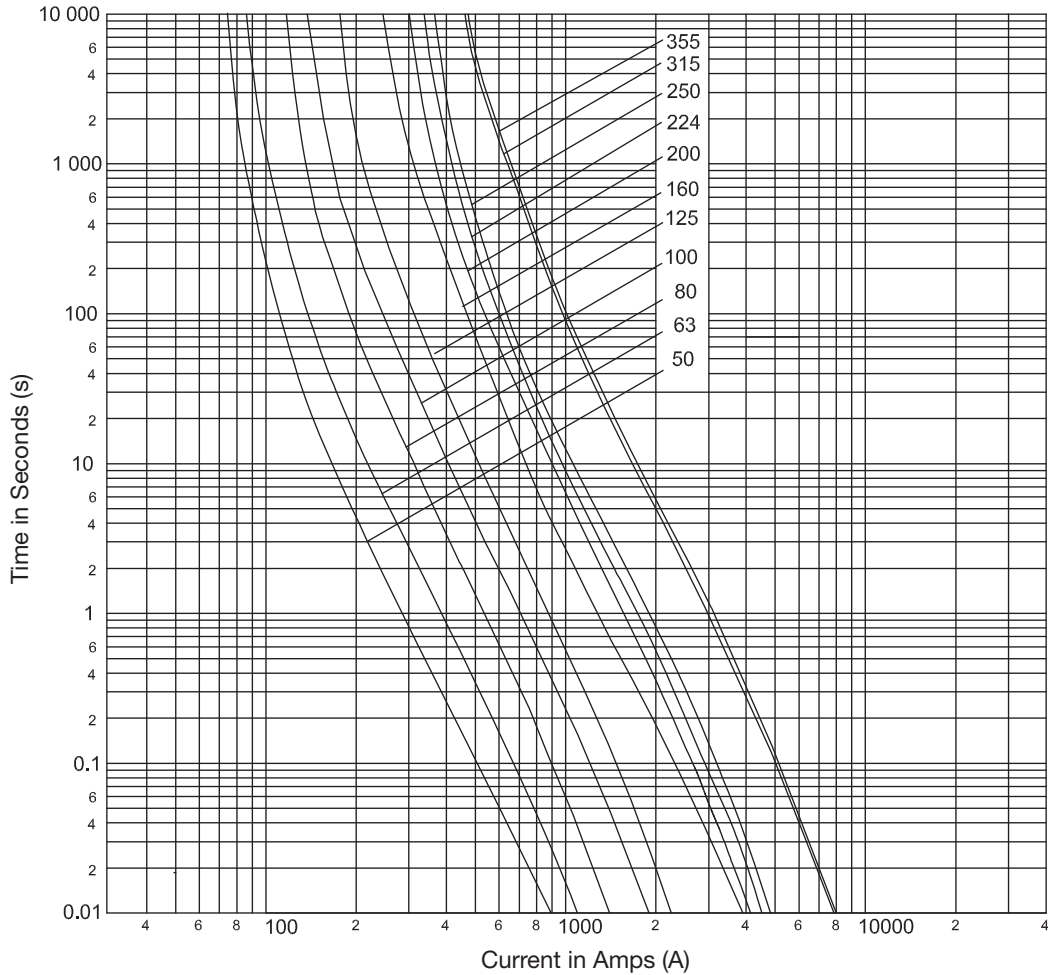

Technical Data

Part numbers with metal gripping lugs	Part numbers with insulated metal gripping lugs	Fuse link size	Rated current (Amps)	Rated voltage (Vac)	I ² t (Amps ² Seconds)		Watts loss	Net weight per fuse (Kg)
					Minimum pre-arcing	*I ₁ 120kA at 500Vac		
50NHG1B	50NHG1BI	1	50	500	6350	18,000	6.4	0.39
63NHG1B	63NHG1BI		63		6800	23,000	5.6	
80NHG1B	80NHG1BI		80		10,500	31,200	7.7	
100NHG1B	100NHG1BI		100		22,000	68,200	8.2	
125NHG1B	125NHG1BI		125		29,000	82,000	13	
160NHG1B	160NHG1BI		160		62,000	310,000	12.3	
200NHG1B	200NHG1BI		200		97,000	368,600	15	
224NHG1B	224NHG1BI		224		124,000	471,200	18	
250NHG1B	250NHG1BI		250		151,300	574,900	19	
315NHG1B	315NHG1BI		315		320,000	750,000	22	
355NHG1B	355NHG1BI		355	320,000	750,000	32		

* I₁ is the maximum breaking capacity test at rated voltage according to IEC 60269-1 and 2 requirements

500Vac class gG/gL - 35 to 250 amps - size 02

Time-current characteristics

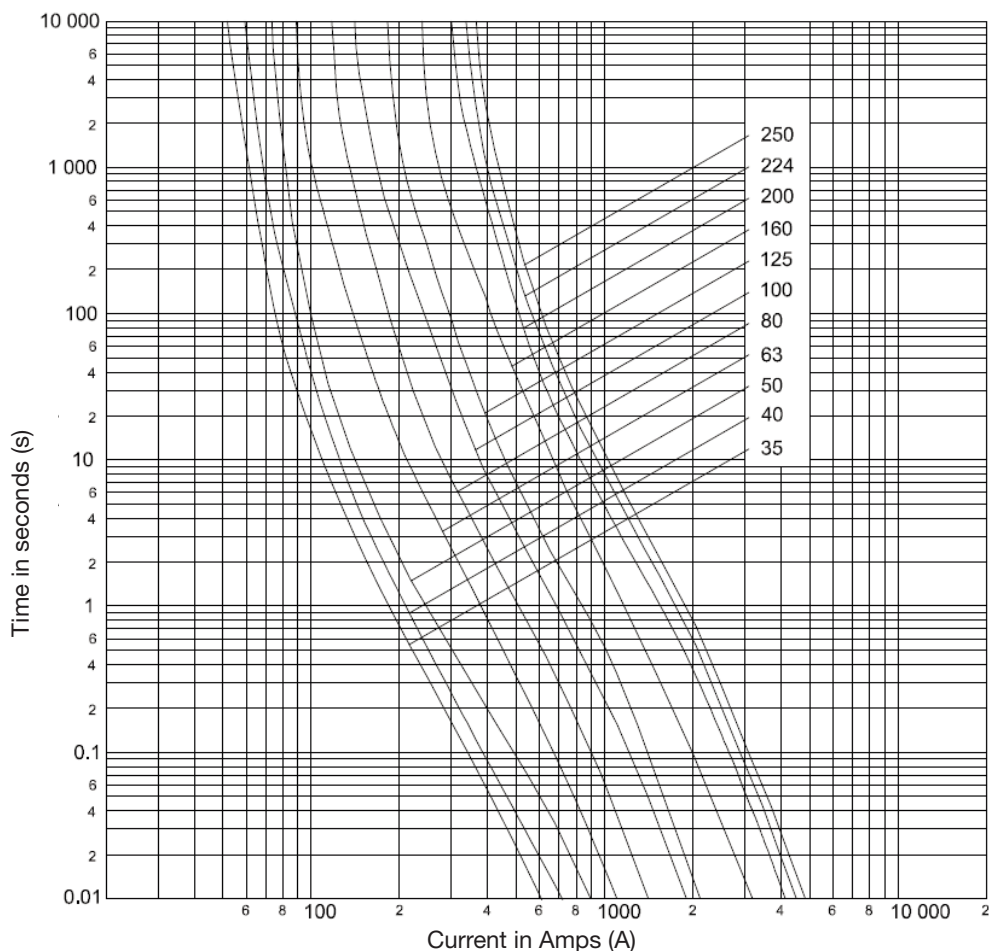

500Vac

Technical data

Part numbers with metal gripping lugs	Part numbers with insulated metal gripping lugs	Fuse link size	Rated current (Amps)	Rated voltage (Vac)	I ² t (Amps ² Seconds)		Watts loss	Net weight per fuse (Kg)
					Minimum pre-arcing	*I ₁ 120kA @ 500Vac		
35NHG02B	35NHG02BI	02	35	500	2400	11,800	4.7	0.402
40NHG02B	40NHG02BI		40		3300	16,500	5	
50NHG02B	50NHG02BI		50		5600	27,800	6.4	
63NHG02B	63NHG02BI		63		6600	26,100	5.5	
80NHG02B	80NHG02BI		80		9800	38,900	7.3	
100NHG02B	100NHG02BI		100		20,600	82,300	7.5	
125NHG02B	125NHG02BI		125		25,000	100,000	12	
160NHG02B	160NHG02BI		160		62,000	248,000	12	
200NHG02B	200NHG02BI		200		96,900	367,900	15	
224NHG02B	224NHG02BI		224		124,000	471,200	18	
250NHG02B	250NHG02BI		250		151,300	574,900	19	

* I₁ is the maximum breaking capacity test at rated voltage according to IEC 60269-1 and 2 requirements

500Vac class gG/gL - 250 to 500 amps - size 2

Time-current characteristics

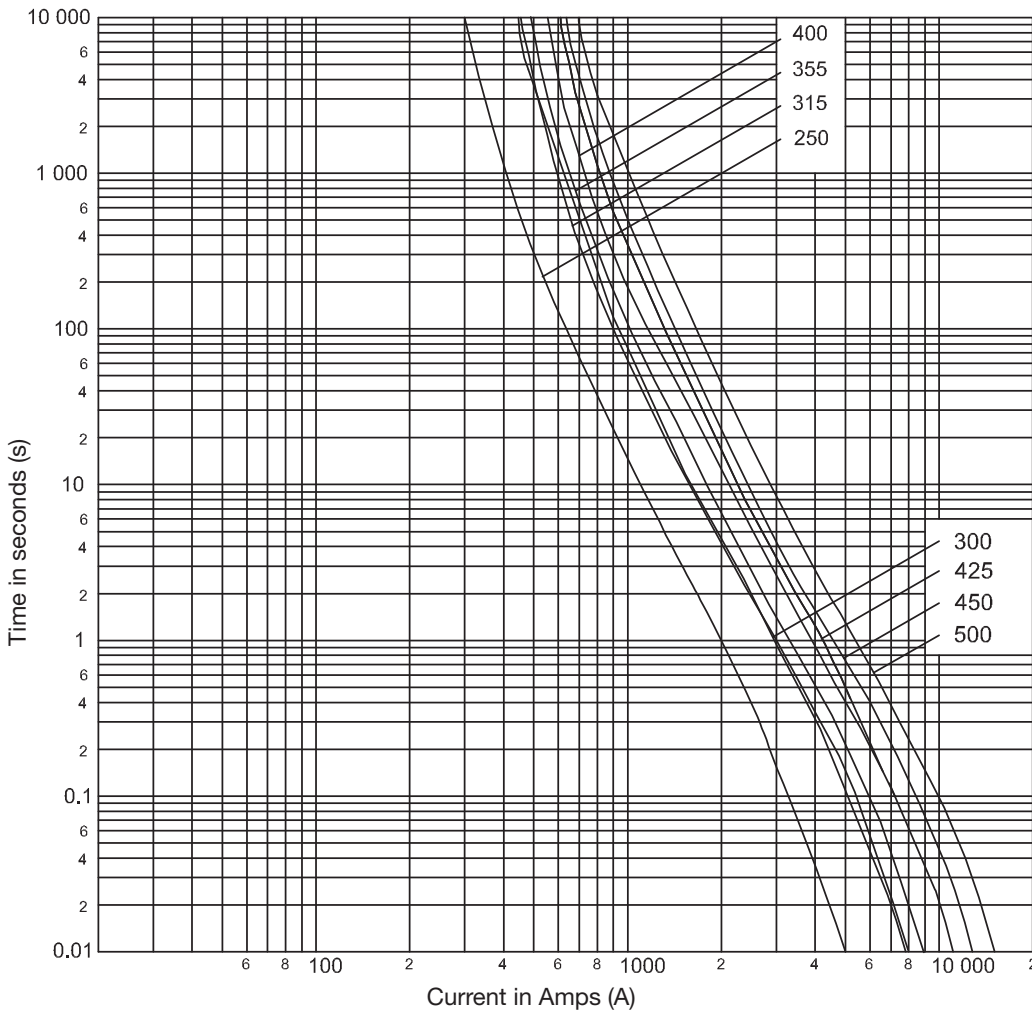

Technical data

Part numbers with metal gripping lugs	Part numbers with insulated metal gripping lugs	Fuse link size	Rated current (Amps)	Rated voltage (Vac)	I ² t (Amps ² Seconds)		Watts loss	Net weight per fuse (Kg)
					Minimum pre-arcing	*I ₁ 120kA at 500Vac		
250NHG2B	250NHG2BI	2	250	500	170,000	437,000	23	0.63
300NHG2B	300NHG1BI		300		320,000	840,000	20	
315NHG2B	315NHG2BI		315		361,700	1,446,500	21	
355NHG2B	355NHG2BI		355		446,500	1,785,800	27	
400NHG2B	400NHG2BI		400		642,900	2,571,500	30	
425NHG2B	425NHG2BI		425		720,000	1,862,000	31	
450NHG2B	450NHG2BI		450		870,000	2,275,000	31	
500NHG2B	500NHG2BI		500		1,200,000	2,720,000	37	
					440			

* I₁ is the maximum breaking capacity test at rated voltage according to IEC 60269-1 and 2 requirements

500Vac class gG/gL - 250 to 400 amps - size 03

Time-current characteristics

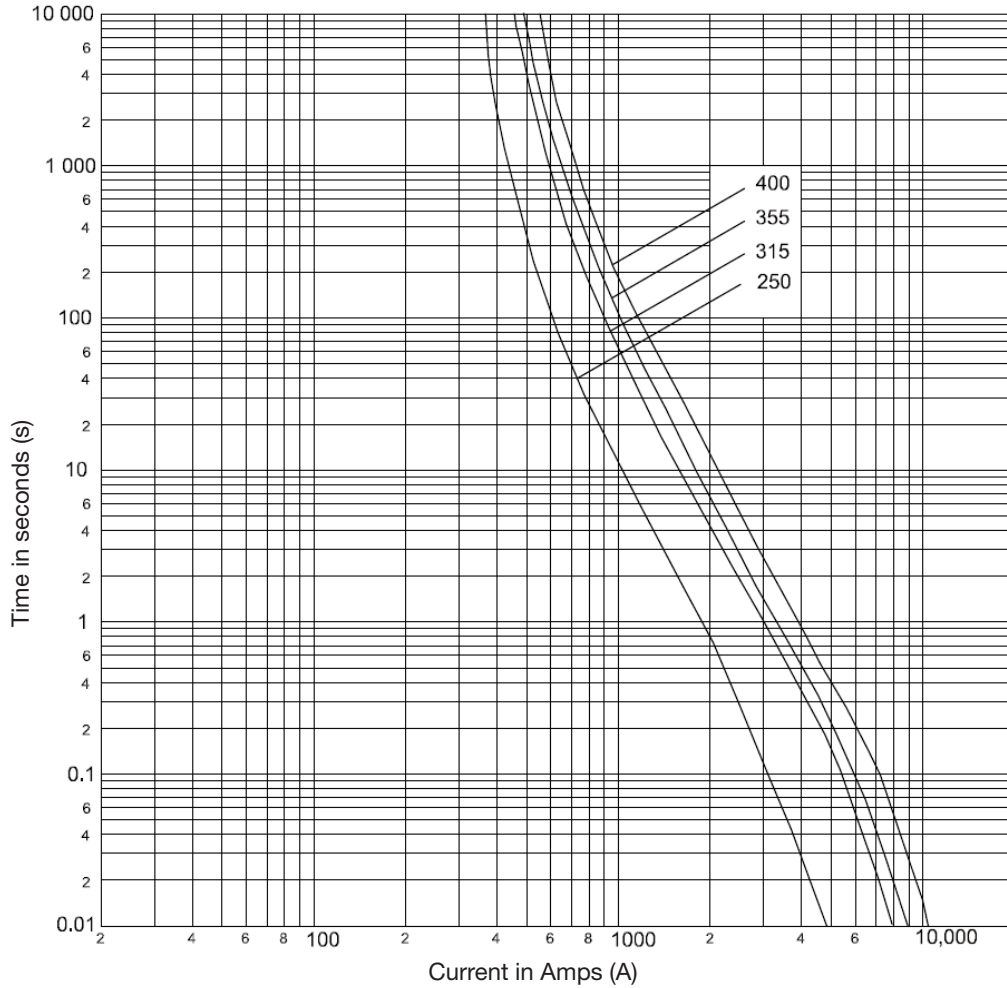

500Vac

Technical data

Part numbers with metal gripping lugs	Part numbers with insulated metal gripping lugs	Fuse link size	Rated current (Amp)	Rated voltage (Vac)	I ² t (Amps ² Seconds)		Watts loss	Net weight per fuse (Kg)
					Minimum pre-arcing	*I ₁ 120kA at 500Vac		
250NHG03B	250NHG03BI	03	250	500	160,800	642,900	20	0.64
315NHG03B	315NHG03BI		315		361,700	1,446,500	21	
355NHG03B	355NHG03BI		355		446,500	1,785,800	27	
400NHG03B	400NHG03BI		400		642,900	2,571,500	30	

* I₁ is the maximum breaking capacity test at rated voltage according to IEC 60269-1 and 2 requirements

500Vac class gG/gL - 315 to 800 amps - size 3

Time-current characteristics

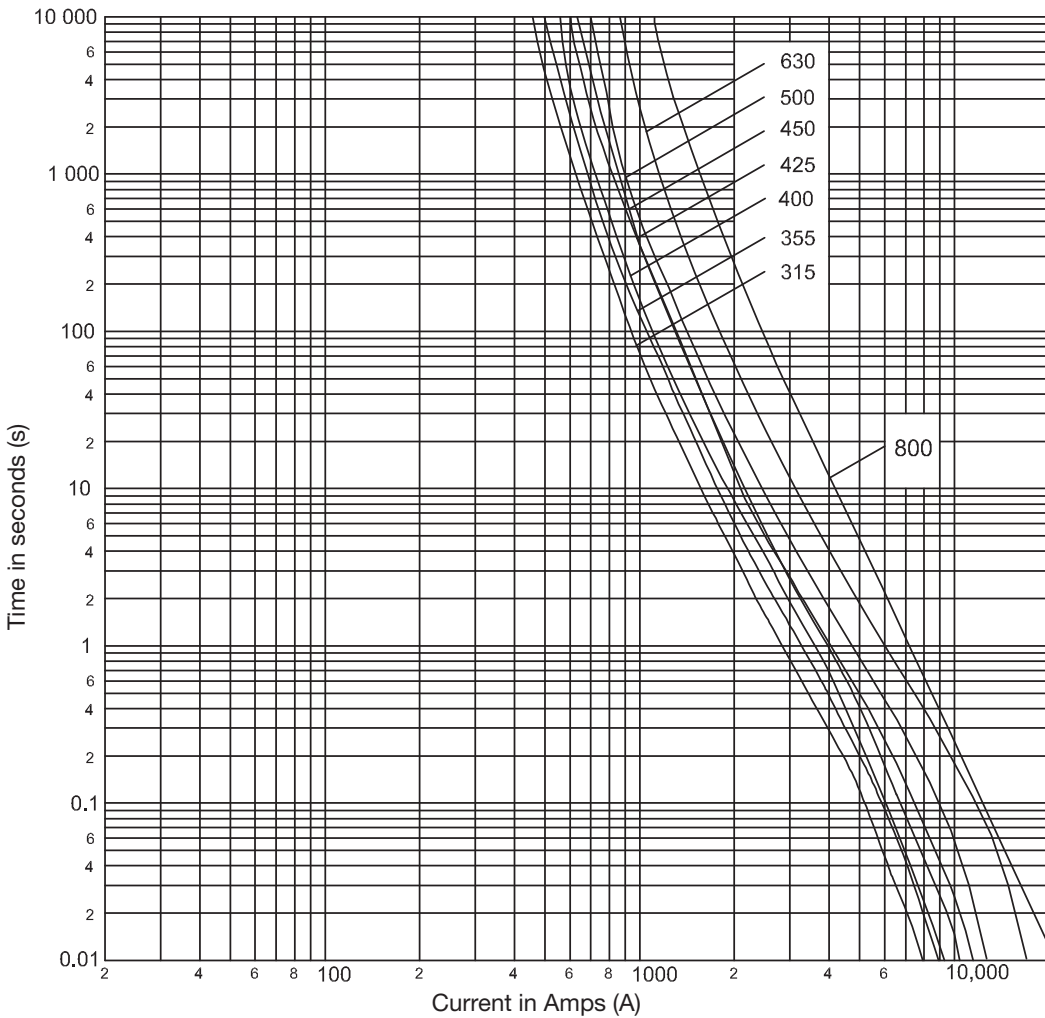

Technical data

Part numbers with metal gripping lugs	Fuse link size	Rated current (Amp)	Rated voltage (Vac)	I ² t (Amps ² Seconds)		Watts loss	Net weight per fuse (Kg)
				Minimum pre-arcing	*I ₁ 120kA at 500Vac		
315NHG3B	3	315	500	375,000	970,000	22	1.05
355NHG3B		355		400,000	1,110,000	25	
400NHG3B		400		642,900	2,571,500	30	
425NHG3B		425		570,000	1,934,000	30	
450NHG3B		450		670,000	2,260,000	33	
500NHG3B		500		886,000	3,898,400	37	
630NHG3B		630		1,590,000	6,996,000	47	
800NHG3B		800		440	2,420,000	5,420,000	

* I₁ is the maximum breaking capacity test at rated voltage according to IEC 60269-1 and 2 requirements

500Vac class gG/gL - 500 to 1250 amps - size 4*

Time-current characteristics

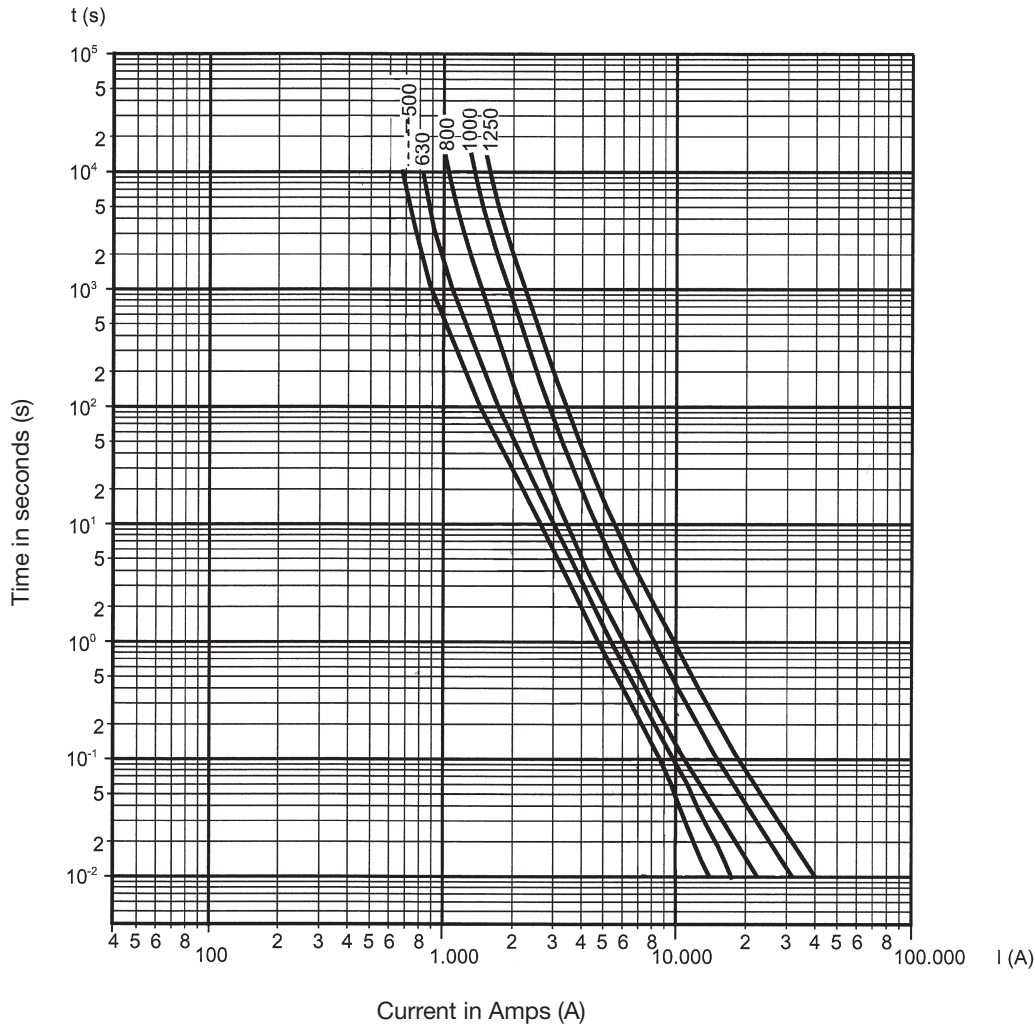

500Vac

Technical data

Part numbers with metal gripping lugs	Fuse link size	Rated current (Amps)	Rated voltage (Vac)	I ² t (Amps ² Seconds)		Watts loss	Net weight per fuse (Kg)
				Minimum pre-arcing	**I ₁ 120kA at 500Vac		
500NHG4G	4	500	500	800,000	3,850,000	37	2.2
630NHG4G		630		880,000	4,100,000	47	
800NHG4G		800		1,500,000	6,480,000	68	
1000NHG4G		1000		4,800,000	13,000,000	80	
1250NHG4G		1250		7,000,000	18,000,000	108	

* Size 4 NH is a single indication fuse with slotted end tags

** I₁ is the maximum breaking capacity test at rated voltage according to IEC 60269-1 and 2 requirements

690Vac class gG/gL - 2 to 800 amps - sizes 000 to 4



Description

A square bodied range of industrial fuse links for a wide variety of applications.

Part number structure

(amp)NHG(size)B-690 e.g. 2NHG000B-690

Class of operation: gL/gG

Standards/approvals

IEC 60269-1 and 2, DIN 43620 Part 1 and 3

Technical data

- Sizes 000 to 4
- Rated voltage: 690Vac
- Rated current: 2 to 800A
- Rated breaking capacity: 120kA
- Operating frequency: 45-62Hz

Optional microswitch

- BVL50 or 170H0236

Compatible fuse holders

- Fuse bases: SD(size)-D, SD(size)-S: 1-pole
TD(size)-D, TD(size)-DI: 3-pole
- Fuse bases accessories: IP20, shroud and phase barrier kits
- Fuse rails - vertical: BFR
- Fuse switch disconnectors vertical: BFD
- Fuse switch disconnectors horizontal: BFH

Environmental:

- Recyclable
- RoHS compliant
- Lead and cadmium free for sizes 000 to 4 (2 to 1250A)

Packaging: All fuse links are packed in 3's.

Features:

- Reliable dual indicator system (size 4 single indication only)
- Low temperature rise
- Globally compliant
- UL on limited ratings

Data sheet 720109

690Vac class gG/gL - 2 to 800 amps - sizes 000 to 4

Part numbers - sizes 000 to 4

Size	Rated current (Amps)	Rated voltage (Vac)	gG/gL dual indicator	Pack quantity
			Voltage conducting metal gripping lugs	
000	2	690	2NHG000B-690	3
	4		4NHG000B-690	3
	6		6NHG000B-690	3
	10		10NHG000B-690	3
	16		16NHG000B-690	3
	20		20NHG000B-690	3
	25		25NHG000B-690	3
	32		32NHG000B-690	3
	35		35NHG000B-690	3
	40		40NHG000B-690	3
	50		50NHG000B-690	3
00	50	690	50NHG00B-690	3
	63		63NHG00B-690	3
	80		80NHG00B-690	3
	100		100NHG00B-690	3
	125		125NHG00B-690	3
1	160	660	160NHG00B-690	3
	50	690	50NHG1B-690	3
	63		63NHG1B-690	3
	80		80NHG1B-690	3
	100		100NHG1B-690	3
	125		125NHG1B-690	3
	160		160NHG1B-690	3
	200		200NHG1B-690	3
	224		224NHG1B-690	3
250	250NHG1B-690		3	
2	200	690	200NHG2B-690	3
	224		224NHG2B-690	3
	250		250NHG2B-690	3
	315		315NHG2B-690	3
3	250	690	250NHG3B-690	3
	315		315NHG3B-690	3
	355		355NHG3B-690	3
	400		400NHG3B-690	3
	425		425NHG3B-690	3
	500		500NHG3B-690	3
4*	630	690	630NHG4B-690	3
	800		800NHG4B-690	3



690Vac gG

*Size 4 is a fuse link with single indication fuse link with slotted end tags

Please consult us should you wish to order 500Volts size 4 buletechnical@eaton.com or 00 44 (0) 1509 882 699

690Vac class gG/gL - 2 to 63 amps - size 000

Time-current characteristics

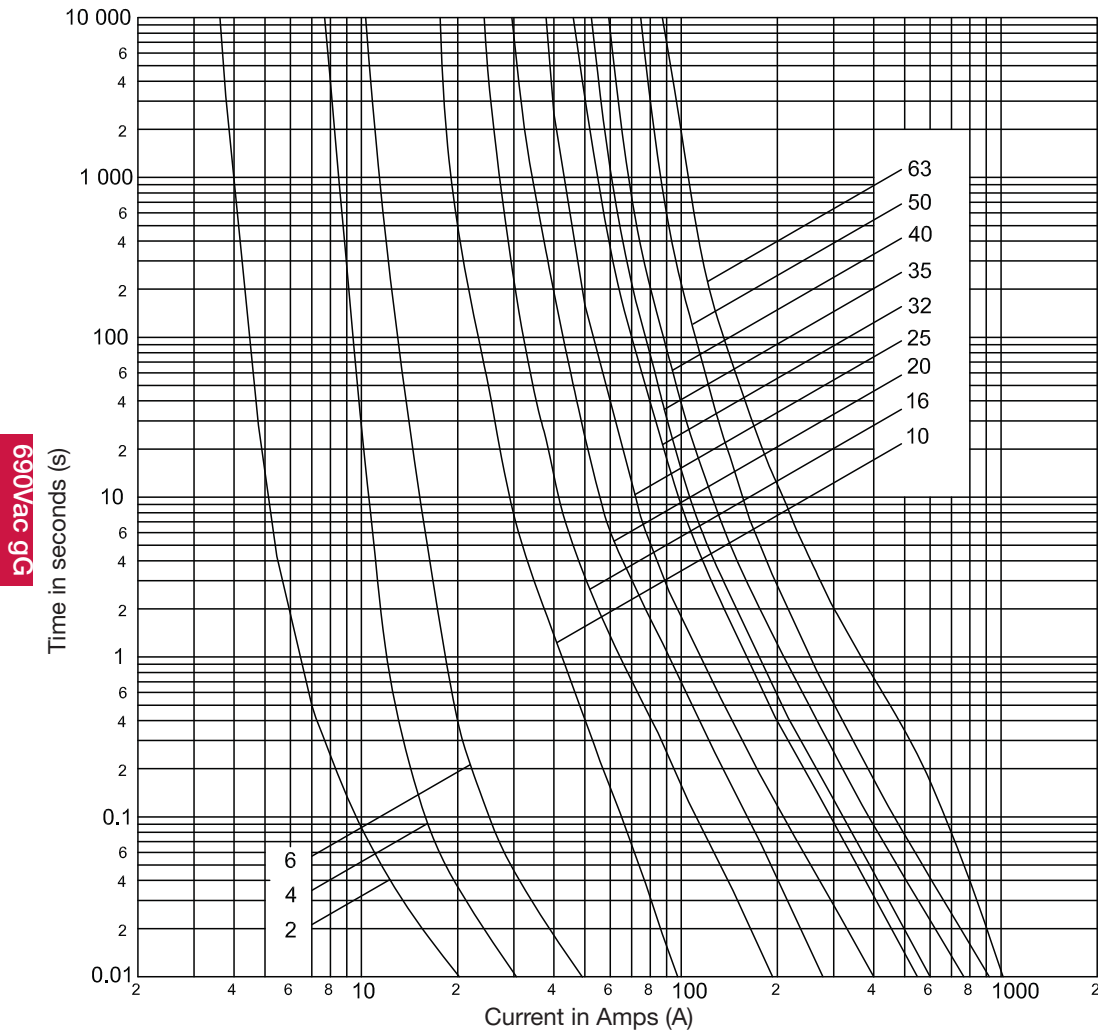

Technical data

Part numbers with metal gripping lugs	Fuse link size	Rated current (Amps)	Rated voltage (Vac)	I ² t (Amps ² Seconds)		Watts loss	Net weight per fuse (Kg)
				Minimum pre-arcing	*I ₁ 120kA at 690Vac		
2NHG000B-690	000	2	690	3.5	8	4	0.118
4NHG000B-690		4		6	16	2	
6NHG000B-690		6		14	25	2	
10NHG000B-690		10		60	400	1.5	
16NHG000B-690		16		240	1200	2.5	
20NHG000B-690		20		500	2500	2.5	
25NHG000B-690		25		920	4400	3.5	
32NHG000B-690		32		1800	9600	3.5	
35NHG000B-690		35		2800	15,000	4	
40NHG000B-690		40		3300	15,000	4	
50NHG000B-690		50		6100	26,500	5.5	
63NHG000B-690		63		6500	30,500	5.5	

* I₁ is the maximum breaking capacity test at rated voltage according to IEC 60269-1 and 2 requirements

690Vac class gG/gL - 50 to 160 amps - size 00

Time-current characteristics

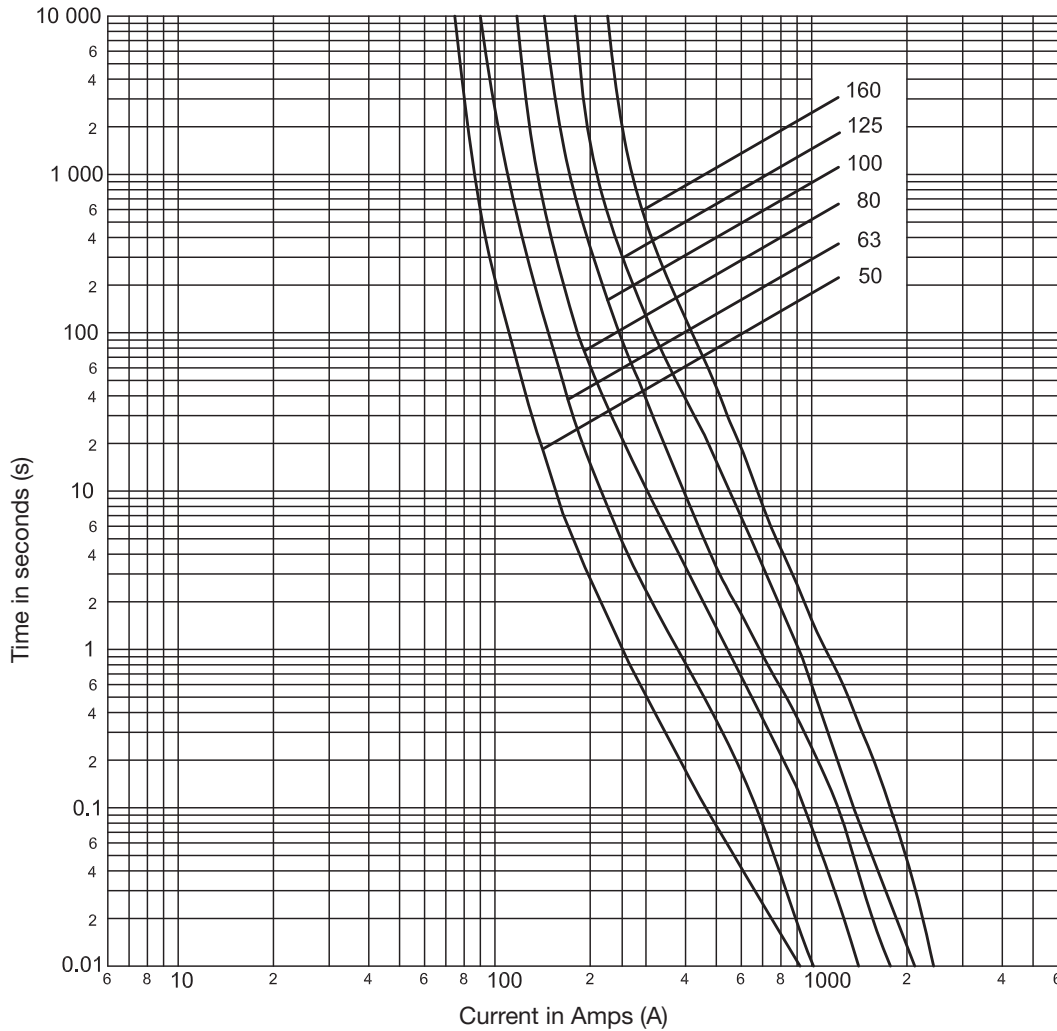

690Vac gG

Technical data

Part numbers with metal gripping lugs	Fuse link size	Rated current (Amps)	Rated voltage (Vac)	I ² t (Amps ² Seconds)		Watts loss	Net weight per fuse (Kg)
				Minimum pre-arcing	*I ₁ 120kA at 690Vac		
50NHG00B-690	00	50	690	5800	35,000	5	0.182
63NHG00B-690		63		5800	43,000	5	
80NHG00B-690		80		11,000	54,500	7	
100NHG00B-690		100		19,000	92,000	7.5	
125NHG00B-690		125		27,500	105,000	9.5	
160NHG00B-690		160	660	40,500	135,000*	13	

* I₁ is the maximum breaking capacity test at rated voltage according to IEC 60269-1 and 2 requirements

690Vac class gG/gL - 50 to 250 amps - size 1

Time-current characteristics

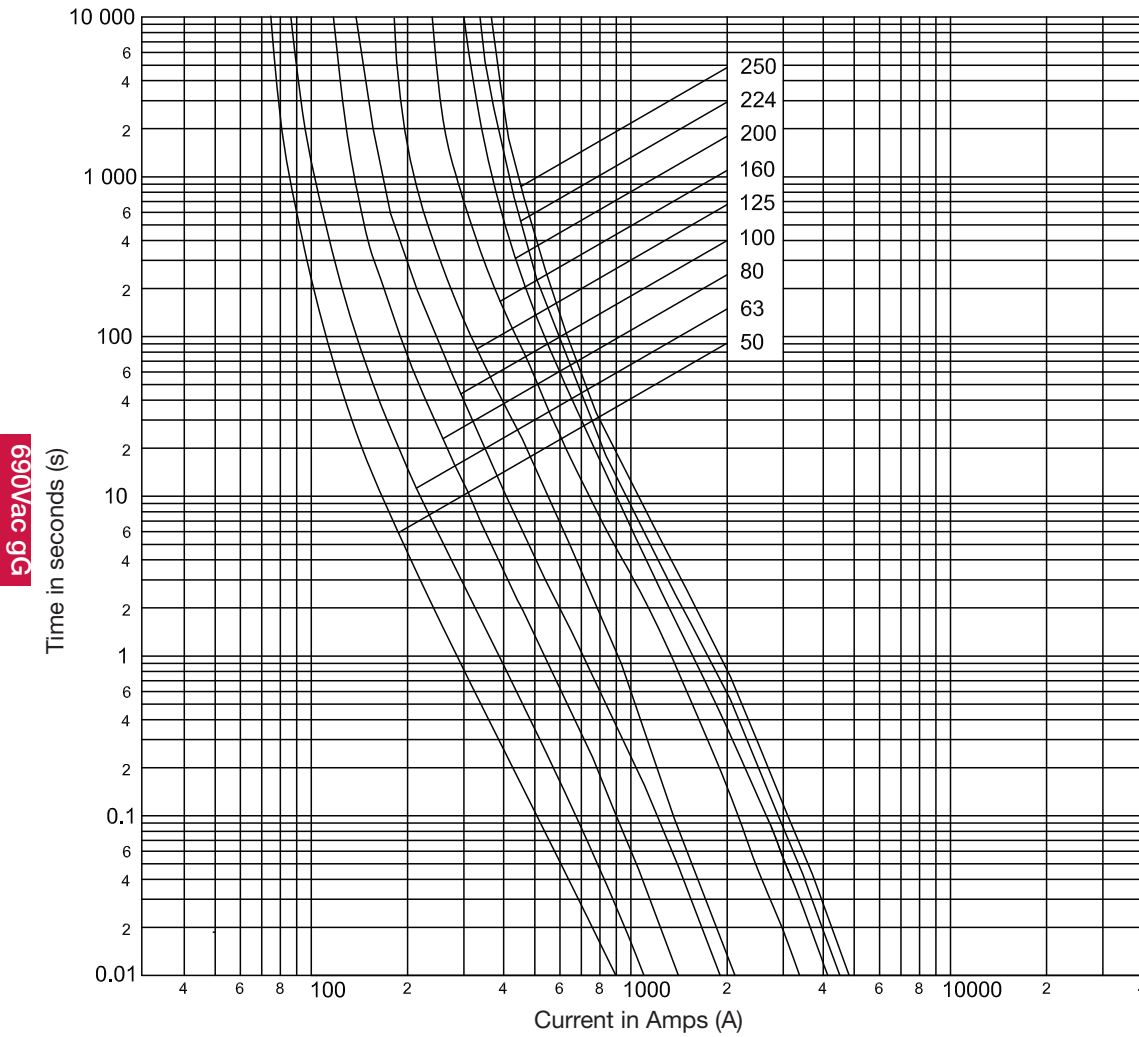

Technical data

Part numbers with metal gripping lugs	Fuse link size	Rated current (Amps)	Rated voltage (Vac)	I ² t (Amps ² Seconds)		Watts loss	Net weight per fuse (Kg)
				Minimum pre-arcing	*I ₁ 120kA at 690Vac		
50NHG1B-690	1	50	690	6350	26,500	6.4	0.38
63NHG1B-690		63		6800	36,000	5.6	
80NHG1B-690		80		10,500	47,500	7.7	
100NHG1B-690		100		22,000	105,000	8.2	
125NHG1B-690		125		29,000	120,000	13	
160NHG1B-690		160		71,000	240,000	13	
200NHG1B-690		200		105,000	350,000	17	
224NHG1B-690		224		120,000	430,000	19	
250NHG1B-690		250		150,000	520,000	22	

* I₁ is the maximum breaking capacity test at rated voltage according to IEC 60269-1 and 2 requirements

690Vac class gG/gL - 200 to 315 amps - size 2

Time-current characteristics

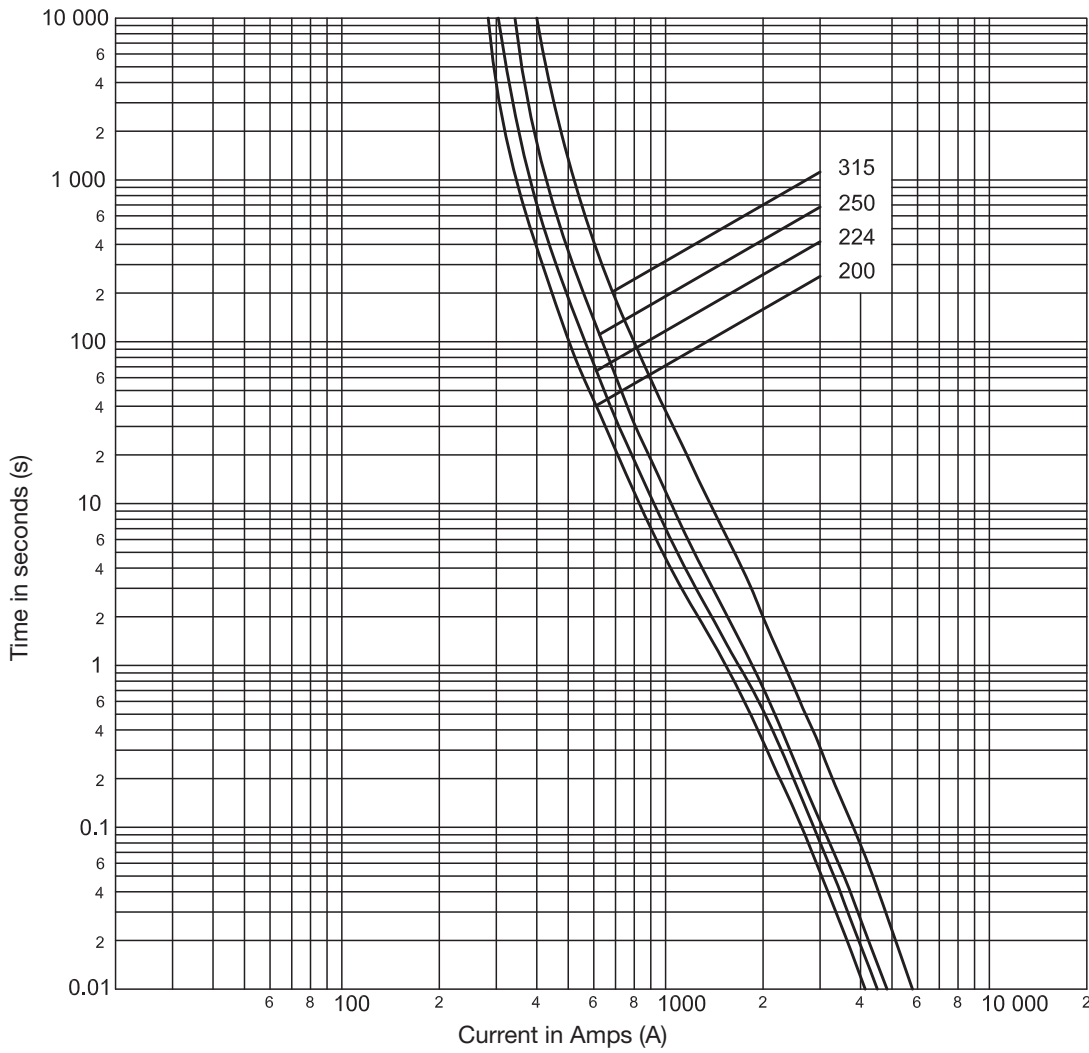

690Vac gG

Technical data

Part numbers with metal gripping lugs	Fuse link size	Rated current (Amps)	Rated voltage (Vac)	I ² t (Amps ² Seconds)		Watts loss	Net weight per fuse (Kg)
				Minimum pre-arcing	*I ₁ 120kA at 690Vac		
200NHG2B-690	2	200	690	99,000	385,000	18	0.62
224NHG2B-690		224		130,000	485,000	20	
250NHG2B-690		250		170,000	625,000	23	
315NHG2B-690		315		295,000	760,000	32	

* I₁ is the maximum breaking capacity test at rated voltage according to IEC 60269-1 and 2 requirements

690Vac class gG/gL - 250 to 500 amps - size 3

Time-current characteristics

690Vac gG

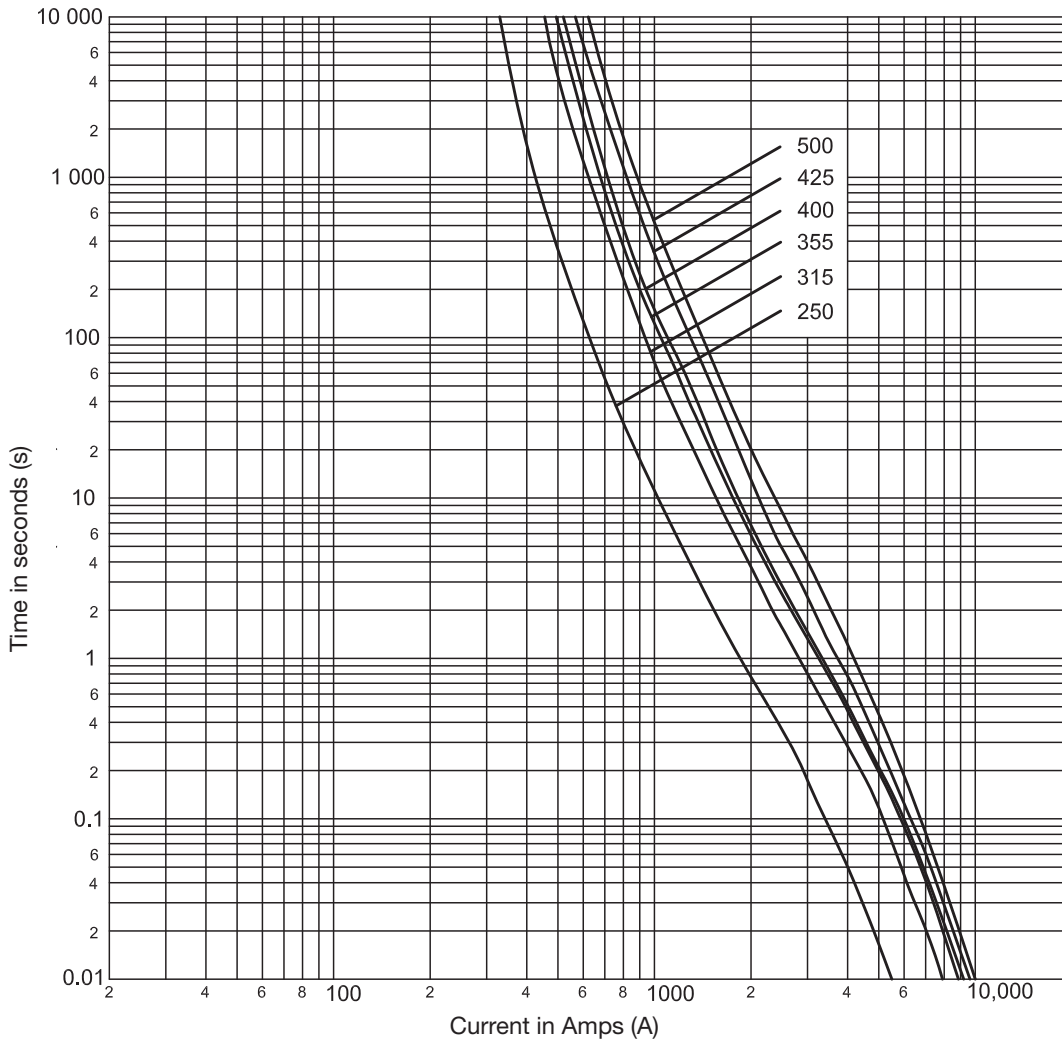

Technical data

Part numbers with metal gripping lugs	Fuse link size	Rated current (Amps)	Rated voltage (Vac)	I ² t (Amps ² Seconds)		Watts loss	Net weight per fuse (Kg)
				Minimum pre-arcing	*I ₁ 120kA at 690Vac		
250NHG3B-690	3	250	690	160,000	715,000	21	0.38
315NHG3B-690		315		375,000	1,400,000	22	
355NHG3B-690		355		400,000	1,650,000	25	
400NHG3B-690		400		475,000	1,600,000	37	
425NHG3B-690		425		630,000	1,700,000	35	
500NHG3B-690		500		856,000	2,480,000	43	

* I₁ is the maximum breaking capacity test at rated voltage according to IEC 60269-1 and 2 requirements

690Vac class gG/gL - 630 and 800 amps - size 4*

Time-current characteristics

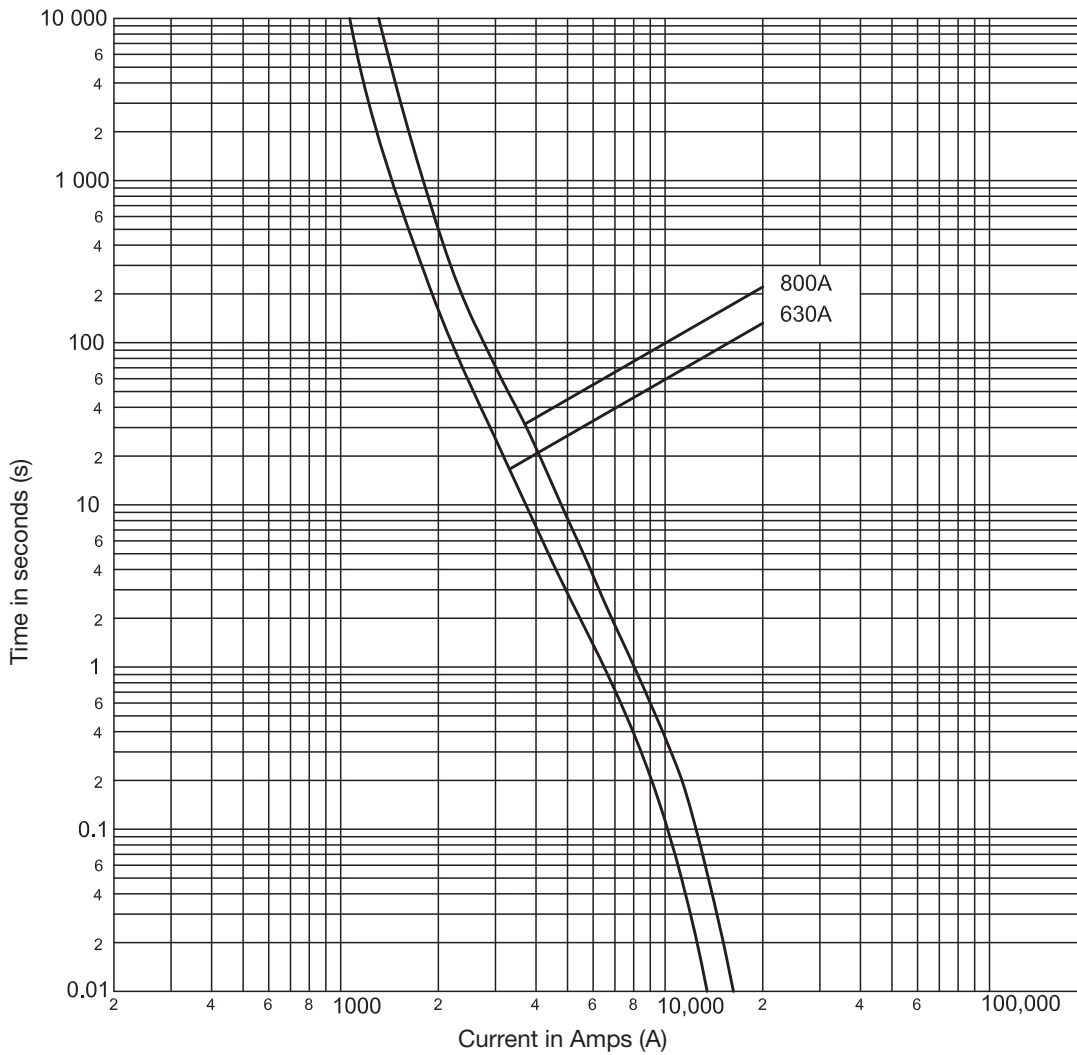

690Vac gG

Technical data

Part numbers with metal gripping lugs	Fuse link size	Rated current (Amps)	Rated voltage (Vac)	I ² t (Amps ² Seconds)		Watts loss	Net weight per fuse (Kg)
				Minimum pre-arcing	**I ₁ 120kA at 690Vac		
630NHG4B-690	4	630	690	1,730,000	6,550,000	44	2.5
800NHG4B-690		800		3,330,000	11,000,000	61	

*Single indication fuse link with slotted end tags

** I₁ is the maximum breaking capacity test at rated voltage according to IEC 60269-1 and 2 requirements

Please consult us should you wish to order 500Volts size 4 buletechnical@eaton.com or 00 44 (0) 1509 882 699

500 and 690Vac class aM - 6 to 500 amps - sizes 000 to 3



Description

A range of class aM square bodied industrial fuse links for a wide variety of motor protection applications.

Part number structure

500Volts: (amp)NHM(size)B

690Volts: (amp)NHM(size)B-690

Class of operation: aM

Standards/approvals

IEC 60269-1 and 2,, DIN 43620 Part 1 and 3

Technical data

- Sizes 000 to 3
- Rated voltage: 500 and 690Vac
- Rated current: 6 to 500A
- Rated breaking capacity: 120kA
- Operating frequency: 45-62Hz

Optional microswitch

- BVL50 or 170H0236

Compatible fuse holders

- Fuse bases: SD(size)-D, SD(size)-S: 1-pole
TD(size)-D, TD(size)-DI: 3-pole
- Fuse bases accessories: IP20, shroud and phase barrier kits
- Fuse rails - vertical: BFR series
- Fuse switch disconnectors vertical: BFD series
- Fuse switch disconnectors horizontal: BFH series

Environmental:

- Recyclable
- RoHS compliant
- Lead and cadmium free

Packaging: All fuse links are packed in 3's.

Features:

- Reliable dual indicator system (except size 2, 315 and 355A which are single indication)
- Low watts loss
- Metal gripping lugs

Data sheet 10165

500 and 690Vac class aM - 6 to 500 amps - sizes 000 to 3

Part numbers - sizes 000 to 3

Size	Rated current (Amps)	500Vac class aM	690Vac class aM	Pack quantity
		Voltage conducting metal gripping lugs	Voltage conducting metal gripping lugs	
000	6	6NHM000B	6NHM000B-690	3
	10	10NHM000B	10NHM000B-690	3
	16	16NHM000B	16NHM000B-690	3
	20	20NHM000B	20NHM000B-690	3
	25	25NHM000B	25NHM000B-690	3
	32	32NHM000B	32NHM000B-690	3
	35	35NHM000B	35NHM000B-690	3
	40	40NHM000B	40NHM000B-690	3
00	50	50NHM000B	50NHM000B-690	3
	63	63NHM00B	63NHM00B-690	3
	80	80NHM00B	80NHM00B-690	3
1	100	100NHM00B	100NHM00B-690	3
	50	50NHM1B	50NHM1B-690	3
	63	63NHM1B	63NHM1B-690	3
	80	80NHM1B	80NHM1B-690	3
	100	100NHM1B	100NHM1B-690	3
	125	125NHM1B	125NHM1B-690	3
2	160	160NHM1B	160NHM1B-690	3
	125	125NHM2B	125NHM2B-690	3
	160	160NHM2B	160NHM2B-690	3
	200	200NHM2B	200NHM2B-690	3
	224	224NHM2B	224NHM2B-690	3
	250	250NHM2B	250NHM2B-690	3
3	315*	315NHM2B*	315NHM2B-690*	3
	355*	355NHM2B*	355NHM2B-690*	3
	315	315NHM3B	315NHM3B-690	3
	355	355NHM3B	355NHM3B-690	3
	400	400NHM3B	400NHM3B-690	3
	500	500NHM3B	500NHM3B-690	3



aM

* Single indication

500 and 690Vac class aM - 6 to 50 amps - size 000

Time-current characteristics

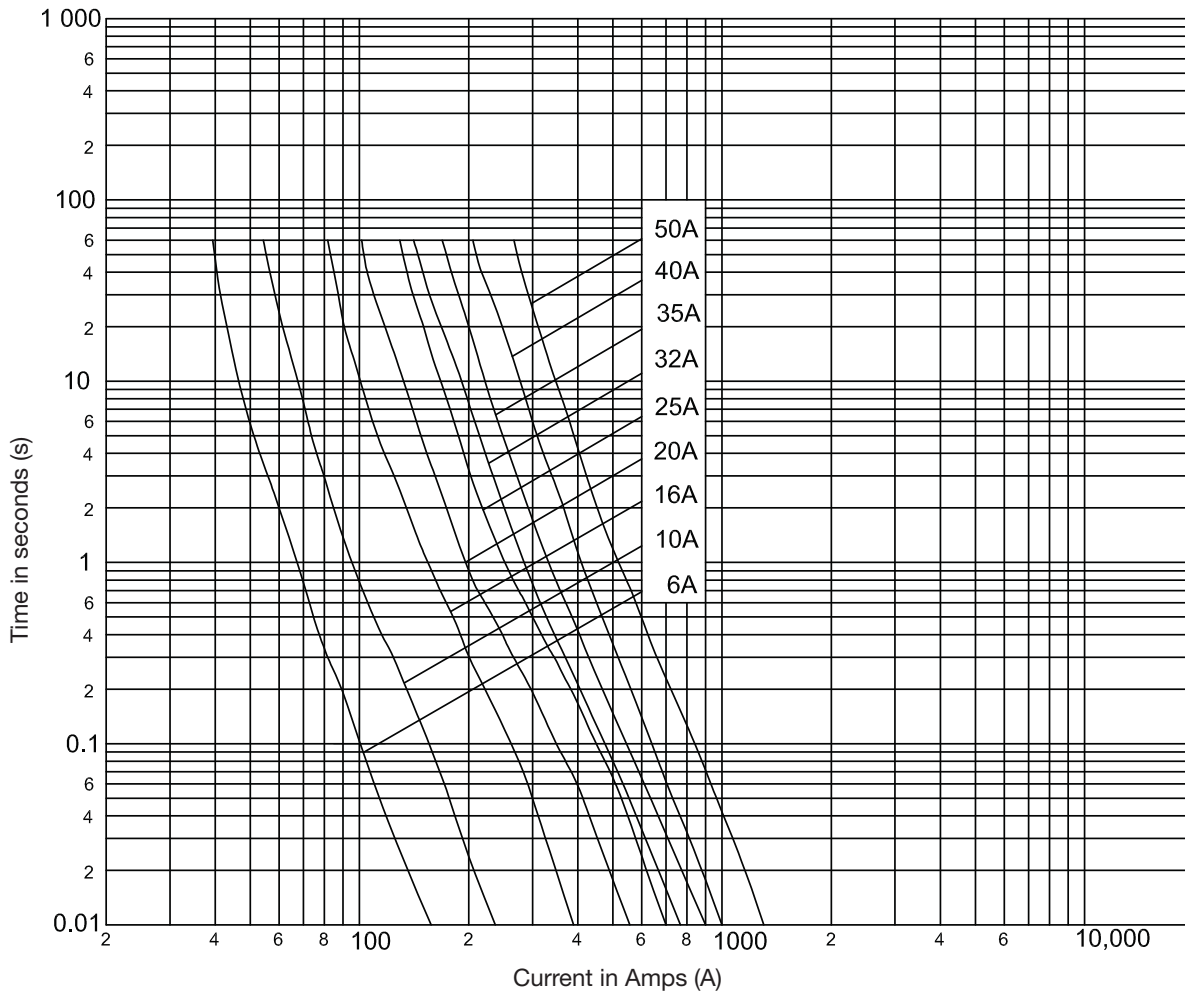

Technical data

500Vac Part numbers with metal gripping lugs	690Vac Part numbers with metal gripping lugs	Fuse link size	Rated current (Amps)	I ² t (Amps ² Seconds)		Watts loss	Net weight per fuse (Kg)
				Minimum pre-arcing	*I ₁ 120kA at 690Vac		
6NHM000B	6NHM000B-690	000	6	48	650	0.3	0.118
10NHM000B	10NHM000B-690		10	200	1800	0.5	
16NHM000B	16NHM000B-690		16	500	4400	0.8	
20NHM000B	20NHM000B-690		20	1450	7250	0.9	
25NHM000B	25NHM000B-690		25	3500	13,500	1.1	
32NHM000B	32NHM000B-690		32	2200	7500	2.1	
35NHM000B	35NHM000B-690		35	3000	12,000	2.1	
40NHM000B	40NHM000B-690		40	4700	14,500	2.3	
50NHM000B	50NHM000B-690		50	11,000	27,000	2.7	

* I₁ is the maximum breaking capacity test at rated voltage according to IEC 60269-1 and 2 requirements

500 and 690Vac class aM - 63 to 100 amps - size 00

Time-current characteristics

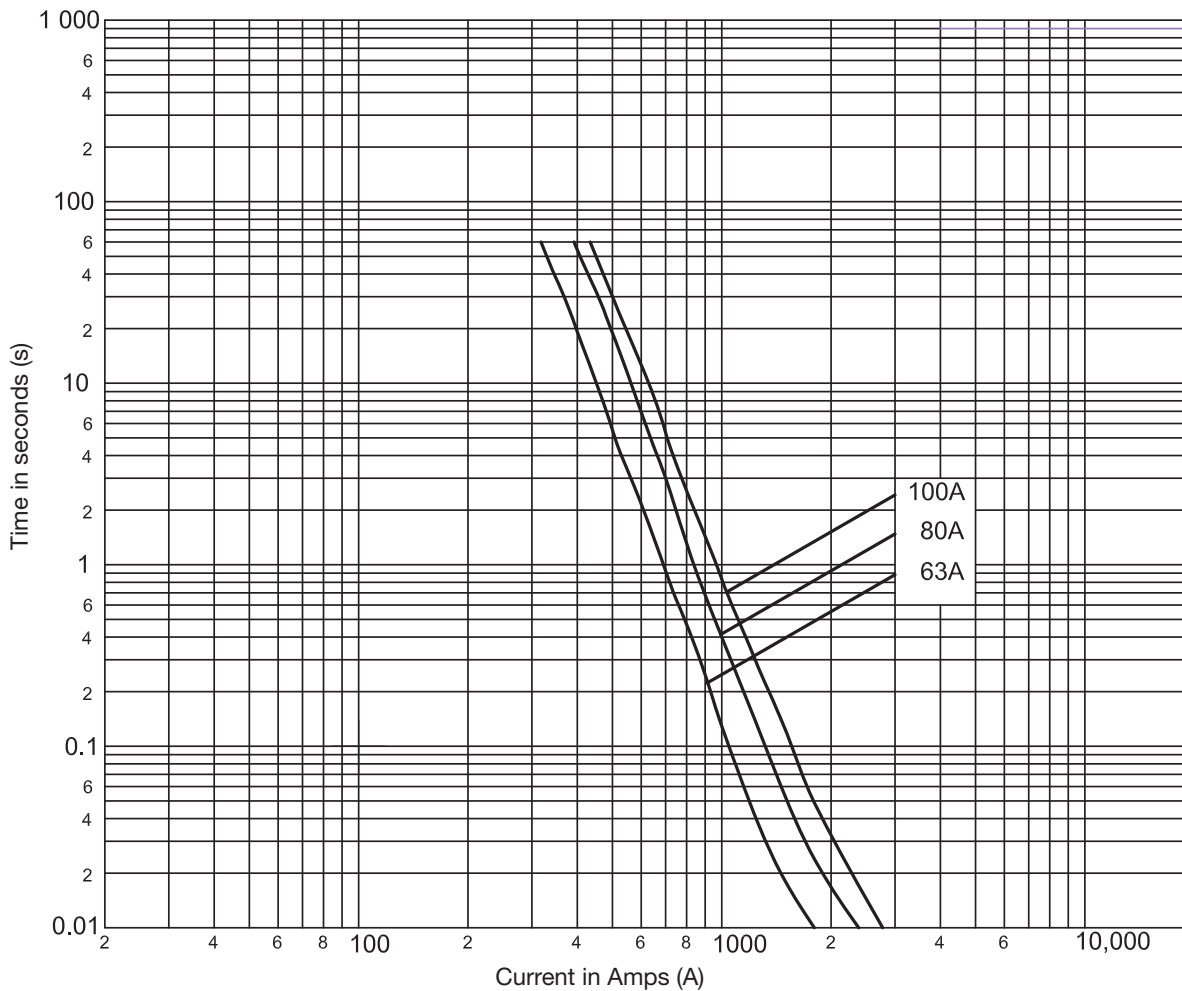

Technical data

500Vac Part numbers with metal gripping lugs	690Vac Part numbers with metal gripping lugs	Fuse link size	Rated current (Amps)	I ² t (Amps ² Seconds)		Watts loss	Net weight per fuse (Kg)
				Minimum pre-arcing	*I ₁ 120kA at 690Vac		
63NHM00B	63NHM00B-690	00	63	16,000	52,000	3.1	0.186
80NHM00B	80NHM00B-690		80	24,000	69,500	4.3	
100NHM00B	100NHM00B-690		100	35,000	110,000	5.5	

* I₁ is the maximum breaking capacity test at rated voltage according to IEC 60269-1 and 2 requirements

500 and 690Vac class aM - 50 to 160 amps - size 1

Time-current characteristics

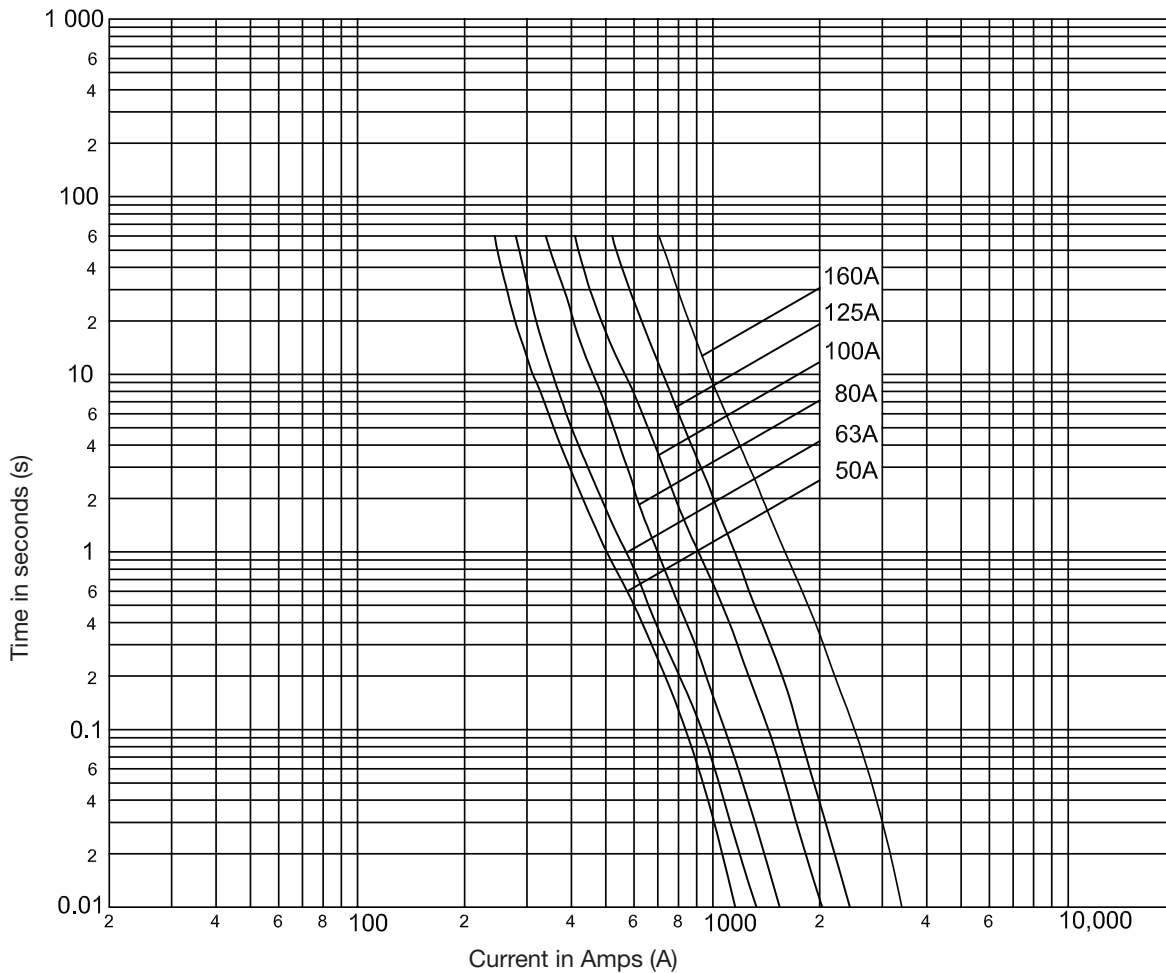

Technical data

500Vac Part numbers with metal gripping lugs	690Vac Part numbers with metal gripping lugs	Fuse link size	Rated current (Amps)	I ² t (Amps ² Seconds)		Watts loss	Net weight per fuse (Kg)
				Minimum pre-arcing	*I ₁ 120kA at 690Vac		
50NHM1B	50NHM1B-690	1	50	10,000	39,500	3	0.38
63NHM1B	63NHM1B-690		63	12,500	49,500	4.4	
80NHM1B	80NHM1B-690		80	19,500	77,500	5.6	
100NHM1B	100NHM1B-690		100	33,000	105,000	6.7	
125NHM1B	125NHM1B-690		125	49,500	170,000	8.8	
160NHM1B	160NHM1B-690		160	110,000	315,000	10.6	

* I₁ is the maximum breaking capacity test at rated voltage according to IEC 60269-1 and 2 requirements

500 and 690Vac class aM - 125 to 355 amps - size 2

Time-current characteristics

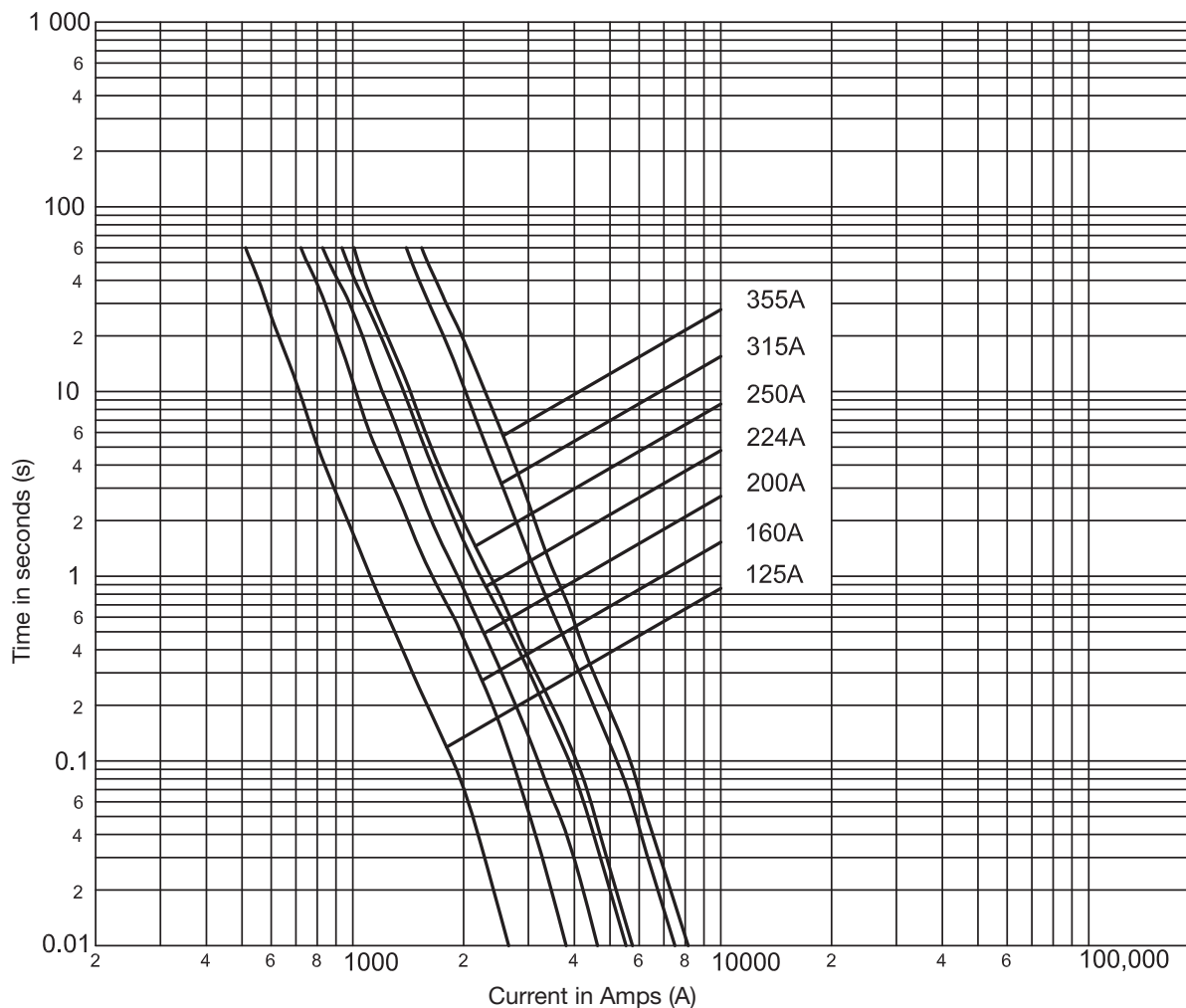

Technical data

500Vac Part numbers with metal gripping lugs	690Vac Part numbers with metal gripping lugs	Fuse link size	Rated current (Amps)	I ² t (Amps ² Seconds)		Watts loss	Net Weight per Fuse (Kg)
				Minimum pre-arcing	**I ₁ 120kA at 690Vac		
125NHM2B	125NHM2B-690	2	125	56,500	215,000	9.7	0.615
160NHM2B	160NHM2B-690		160	120,000	510,000	11	
200NHM2B	200NHM2B-690		200	175,000	730,000	14	
224NHM2B	224NHM2B-690		224	255,000	1,050,000	15	
250NHM2B	250NHM2B-690		250	300,000	1,280,000	17	
315NHM2B*	315NHM2B-690*		315	510,000	1,150,000	23	
355NHM2B*	355NHM2B-690*		355	570,000	1,300,000	28	

* Single indication

** I₁ is the maximum breaking capacity test at rated voltage according to IEC 60269-1 and 2 requirements



500 and 690Vac class aM - 315 to 500 amps - size 3

Time-current characteristics

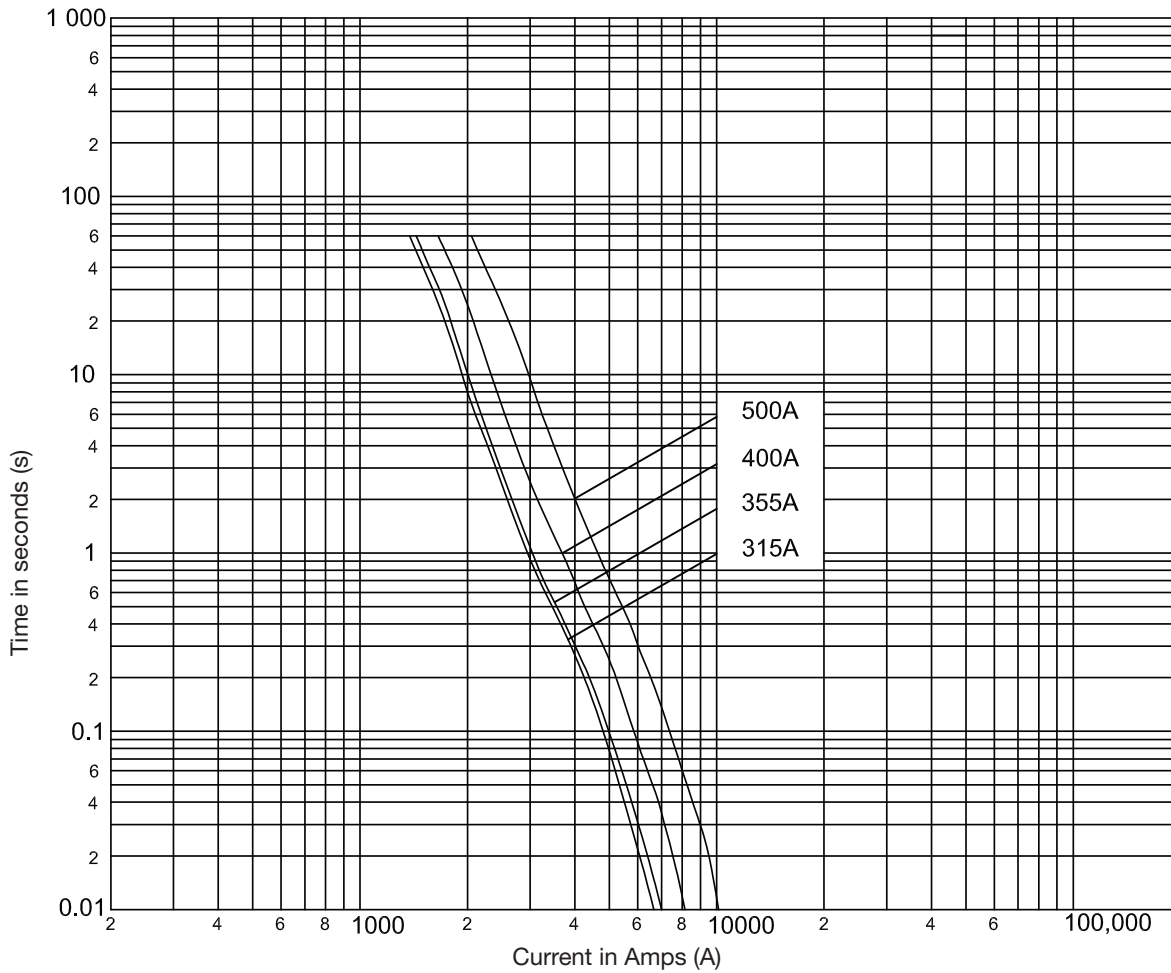

Technical data

500Vac Part numbers with metal gripping lugs	690Vac Part numbers with metal gripping lugs	Fuse link size	Rated current (Amps)	I ² t (Amps ² Seconds)		Watts loss	Net weight per fuse (Kg)
				Minimum pre-arcing	*I ₁ 120kA at 690Vac		
315NHM3B	315NHM3B-690	3	315	480,000	1,600,000	20	1.05
355NHM3B	355NHM3B-690		355	500,000	1,300,000	27	
400NHM3B	400NHM3B-690		400	680,000	2,000,000	28	
500NHM3B	500NHM3B-690		500	1,050,000	2,800,000	36	

* I₁ is the maximum breaking capacity test at rated voltage according to IEC 60269-1 and 2 requirements

NH Fuse bases and accessories - SD and TD series



Description

NH fuse bases with thermoplastic bodies, DIN rail and/or screw mounting (size 4 screw mounting only). Range of accessories including phase barriers, IP20 finger-safe protection kits and neutral links available.

Microswitch also available for remote signaling of fuse link operation.

Part number structure

SD(size)-D, SD(size)-S: 1-pole

TD(size)-D, TD(size)-DI: 3-pole

Standards/approvals

IEC 60269-1 and 2, VDE 0636-1 and 2

Technical data

- Rated voltage: 690Vac
- Rated current: 160 to 1600A
- Rated for fuse links with breaking capacity: 120kA

Compatible fuse links

- NH 400, 500 and 690V NH gG and aM fuse links

Packaging:

- 1-pole: 3, SD4 and 3-pole: 1
- Packaging 100% recyclable

Features:

- Complies with IEC 60269-1 and 2 fuse system A (NH base), manufacturers type test certificates of compliance available.
- 3-pole integral NH00 base available with reduced width.
- Clip-in phase barriers, terminal shrouds and fuse covers available.
- Vibration tested to IEC 60068-2-6 for marine use.

Fuse base part numbers

Size	Poles	Current (Amps)	Part numbers		Unit packing	Compatible fuse links size
			DIN-Rail and screw mounting	Screw mounting only		
00	1-pole	160	SD00-D	SD00-S	3	400/500/690V NH gG and aM fuse links
	3-pole	160	TD00-D	N/A	1	
		160	TD00-DI*	N/A	1	
1	1-pole	250	SD1-D	SD1-S	3	
	3-pole	250	TD1-D	N/A	1	
2	1-pole	400	SD2-D	SD2-S	3	
		400	SD2-DD**	N/A	3	
	3-pole	400	TD2-D	N/A	1	
		400	TD2-DD**	N/A	1	
3	1-pole	630	SD3-D**	SD3-S	3	
	3-pole	630	TD3-D**	N/A	1	
4	1-pole	1250	N/A	SD4-S	1	
		1600	N/A	SD4-S1600	1	

* 3-pole integral base moulding.

** Double fuse contact clips.

NH Fuse bases and accessories - SD and TD series

Technical data

Fuse base part numbers		SD00-D TD00-D TD00-DI	SD1-D TD1-D	SD2-D TD2-D	SD3-D TD3-D	SD4-S	SD4-S1600
Base		Glass filled PBT					
Contacts		Silver plated copper					
Screw, nuts and washers		Zinc clear plated steel					
Derating temperature factors for maximum current	≤ 35°C	1	1	1	1	1	1
	40°C	0.95	0.95	0.95	0.95	0.95	0.95
	50°C	0.85	0.85	0.85	0.85	0.85	0.85
Maximum power acceptance		12W	32W	45W	60W	110W	145W
Degree of protection with covers fitted		IP20	IP20	IP20	IP20	-	-
Terminal screw		M8	M10	M10	M12	M16	M16
Maximum tightening torque terminal screw		10N•m	32N•m	32N•m	32N•m	56N•m	56N•m
Fixing	DIN-Rail	✓	✓	✓	✓	x	x
	Screw	✓	✓	✓	✓	✓	✓
With microswitch 16A/250V	Fuse operated signal	✓	✓	✓	✓	x	x
Operating temperature range		-20 to 70°C					
Storage temperature range		-40 to 80°C					

Solid links part numbers

Size	Current (Amps)	Part number	Unit packing
NH00	160	SDL-00	3
NH1	250	SDL-1	3
NH2	400	SDL-2	3
NH3	630	SDL-3	3

Accessories

Accessories

Fuse extraction handle

Size	Current (Amps)	Part number	Unit packing
NH00-3	160 - 630	FEH	1



Shroud kits

Fuse base series	Fuse size	Current (Amps)	Part number	Description
SD1	NH1	250	SD12-SK	Kit includes 2 shrouds and 1 fuse cover
SD2	NH2	400	SD12-SK	
SD3	NH3	630	SD3-SK	



Shroud kit

NH Fuse bases and accessories - SD and TD series

Accessories

Phase barrier kits

Size	Current (Amps)	Phase barrier kit		Description
		Part number	Unit packing	
NH00	160	SD00-PB	1	2-Phase barriers
NH1	250	SD12-PB	1	2-Phase barriers and 2 ganging links
NH2	400	SD12-PB	1	
NH3	630	SD3-PB	1	



Phase barrier



Ganging link

IP protection kits

Size	Current (Amps)	Part number	Fuse cover	Shroud	Phase barrier	Ganging link	Integral kit	Description
NH00	160	TD00-IP20	3	6	2			Triple pole protection kit for TD00-D with shrouds, fuse covers and phase barriers
		TD00-IP20I					1	Integral triple pole protection kit for TD00-DI with molded shrouds and phase barriers
		TD00-IP20IC	3				1	Integral triple pole protection kit for TD00-DI with fuse covers and molded shrouds and phase barriers
NH1	250	TD1-IP20	3	6	2	2		Triple pole protection kit with terminal shrouds, fuse cover phase barriers and ganging links
NH2	400	TD2-IP20						
NH3	630	TD3-IP20						



TD00-IP20



TD00-IP20I



TD00-IP20IC



TD(size 1 to 3)-IP20

Microswitch

Part number	Unit packing	Ratings
BVL50	1	6A 250Vac
170H0236	12	2A 250Vac
170H0238	12	2A 250Vac



Microswitch suitable for the following NH fuse links:

- 400 Volts gG/gL
- 500 Volts gG/gL and aM
- 690 Volts gG/gL and aM

Note: Microswitches fit onto the fuse gripping lugs and are applicable to all NH size Bussmann fuses.

NH Fuse bases and accessories - SD and TD series

Dimensions (mm) 1-pole, size 00

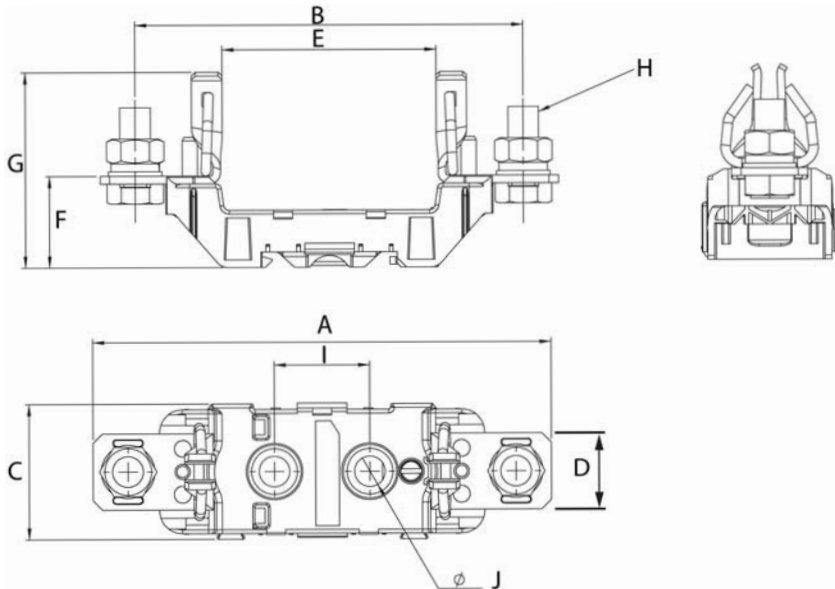

Size	Pole	A	B	C	D	E	F	G	H	I	J
NH00	1-pole	120	102	35.5	20	56	24	51	M8x20	25	8

Dimensions (mm) 1-pole, sizes 1, 2 and 3

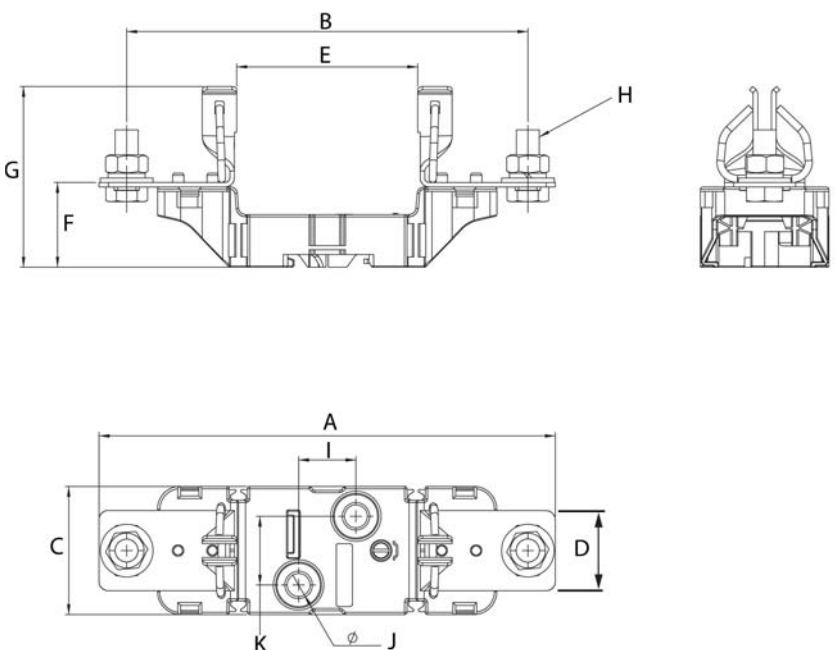

Size	Poles/Type	A	B	C	D	E	F	G	H	I	J	K
NH1	1-pole	199	175	56	35	79	37	78	M10x25	25	10	30
NH2	1 pole	224	199	56	35	79	37.5	86	M10x25	25	10	30
	1-pole double clip	223	199	56	35	82	37	79	M10x25	25	10	30
NH3	1-pole	239	209	56	36	82	37.5	88	M12x30	25	10	30

NH Fuse bases and accessories - SD and TD series

Dimensions (mm) 1-pole, size 4

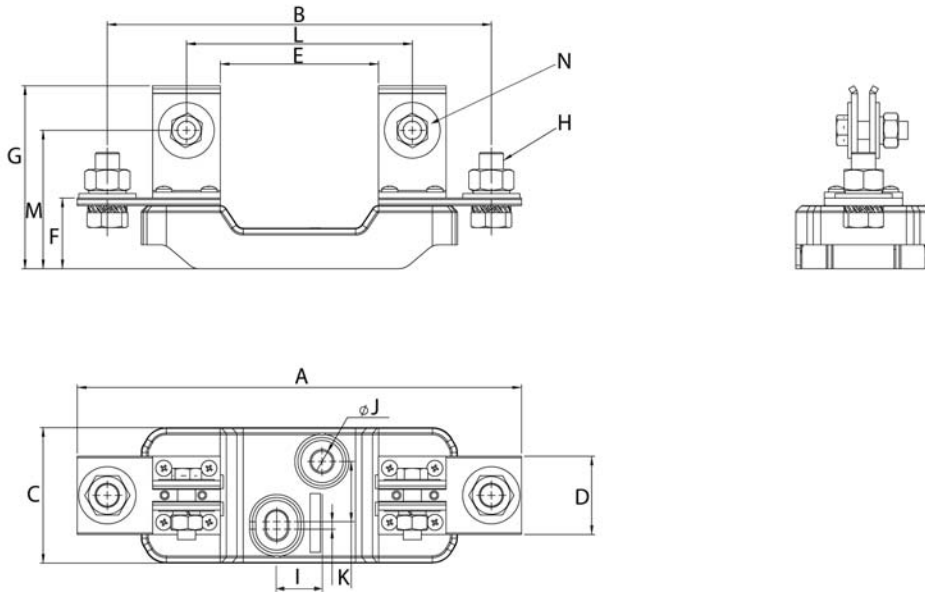

Size	Poles/Type	A	B	C	D	E	F	G	H	I	J	K	L	M	N
NH4	1-pole 1250A	295	255	90	52	105	47	122	M16x40	30	14	40	150	92	M12x40
	1-pole 1600A	295	255	90	60	105	50	125	M16x40	30	14	40	150	92	M12x40

Dimensions (mm) 3-pole, size 00

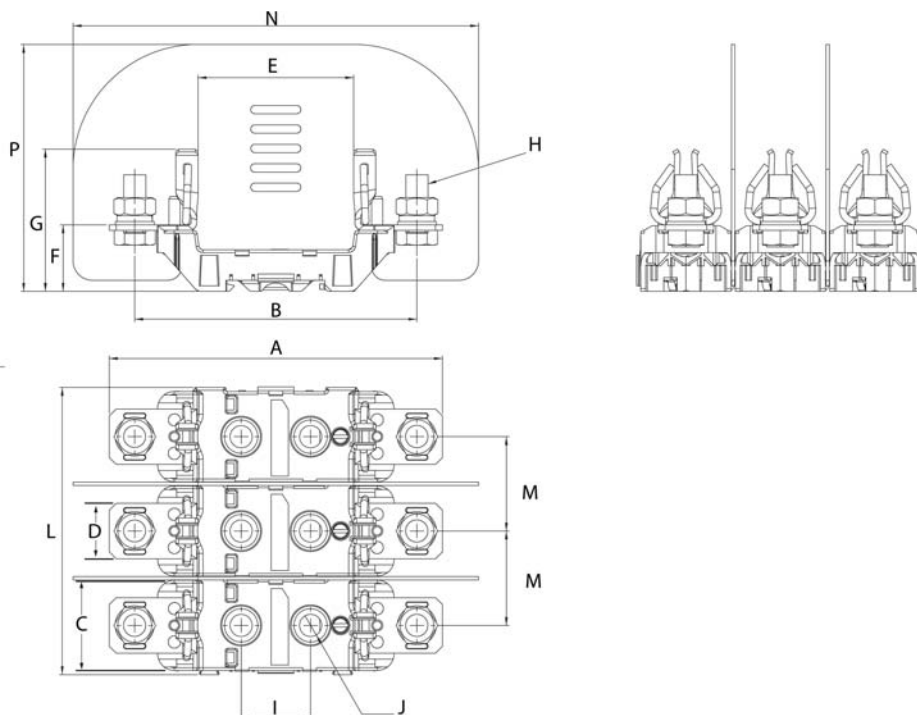

Size	Poles/Type	A	B	C	D	E	F	G	H	I	J	K	L	M	N	P
NH00	3-pole	120	102	35.5	20	56	24	51	M8x20	25	8	-	103.5	34	146	89

NH Fuse bases and accessories - SD and TD series

Dimensions (mm) integral 3-pole, size 00

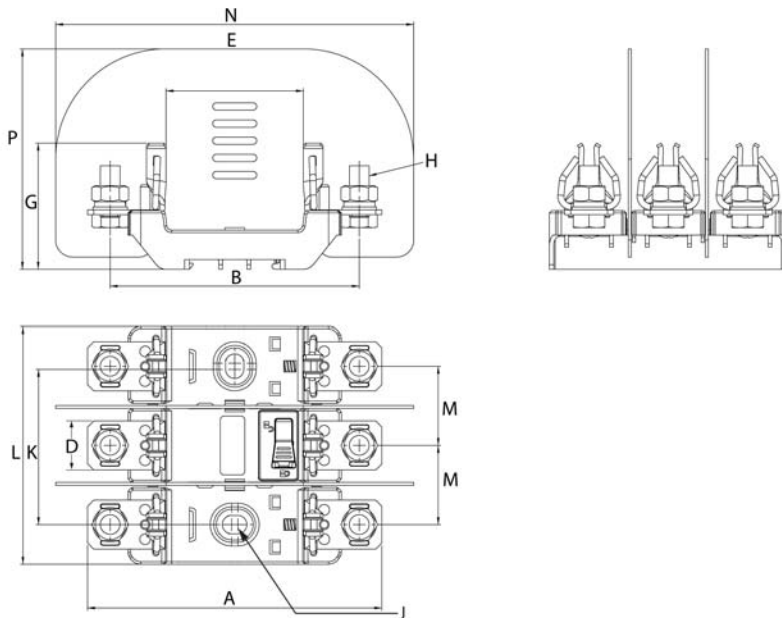

Size	Poles/Type	A	B	C	D	E	F	G	H	I	J	K	L	M	N	P
NH00	3-pole Integral	120	102	-	20	56	24	51	M8x20	-	7.5x10	63.5	97	32.3	146	90

Dimensions (mm) 3-pole, sizes 1, 2 and 3

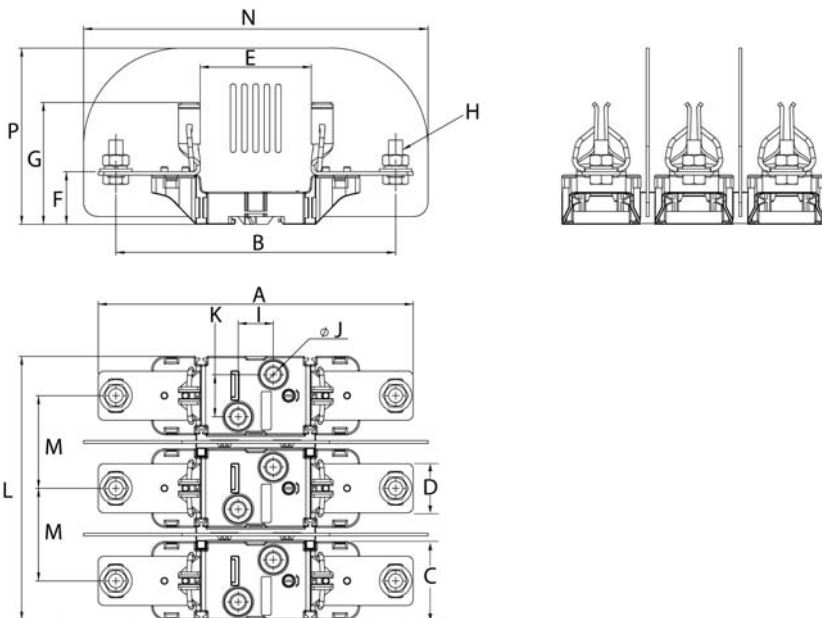

Size	Poles/Type	A	B	C	D	E	F	G	H	I	J	K	L	M	N	P
NH1	3-pole	199	175	56	35	79	37	78	M10x25	25	10	30	188	66	245	125.5
NH2	3-pole	224	199	56	35	79	37.5	86	M10x25	25	10	30	188	66	245	125.5
	3-pole double clip	223	199	56	35	82	37	79	M10x25	25	10	30	188	66	245	125.5
NH3	3-pole	239	209	56	36	82	37.5	88	M12x30	25	10	30	221	82.5	260	137.5

Data sheet 10163

NH Fuse rails - vertical - BFR series

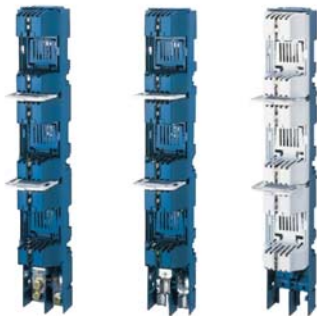

Description

NH fuse rails to be used with NH fuse links. Fully protected against accidental contact.

Part number structure

BFR00-3D-FC - Size 00 M8 cable connections

BFR(size)-3K-LM-C: Pressed-in nuts with M10 screw

BFR(size)-3K-LW: V-shaped clamps

BFR(size)-3K-LL: For use on Busbar systems with 185mm spacing. Connects to Busbar with M12 Bolts

Standards/approvals

IEC 60269-1 and 2, and CE

Technical data

- Rated voltage: 690Vac
- Rated current: 160 to 630A

Compatible fuse links

- NH 400, 500 and 690V NH gG and aM fuse links

Packaging:

- 1 per carton

Features:

- Contact covers.
- Phase barriers.
- Label for protected circuit identification.
- Busbar mounting option.

Part numbers

Size	Current (Amps)	Part number	Leading out terminals	Unit packing	Compatible fuse links size
00	160	BFR00-3D-FC	M8 cable connections	1	000 and 00
1	250	BFR1-3K-LM-C*	Pressed-in nuts with M10 screws	1	01 and 1
		BFR1-3K-LW	V-shaped terminals for 5845 clamps**		
		BFR1-3K-LL	For use on Busbar system with 185mm spacing. Connects to Busbar with M12 Bolts		
2	400	BFR2-3K-LM-C*	Pressed-in nuts with M10 screws	1	02 and 2
		BFR2-3K-LW	V-shaped terminals for 5845 clamps**		
		BFR2-3K-LL	For use on Busbar system with 185mm spacing. Connects to Busbar with M12 Bolts		
3	630	BFR3-3K-LM-C*	Pressed-in nuts with M10 screws	1	03 and 3
		BFR3-3K-LW	V-shaped terminals for 5845 clamps**		
		BFR3-3K-LL	For use on Busbar system with 185mm spacing. Connects to Busbar with M12 Bolts		

* With leading-out terminal cover

** The clamps must be ordered separately

NH Fuse rails - vertical - BFR series

Technical data

Type		BFR00	BFR1	BFR2	BFR3
Rated current	I_n	160A	250A	400A	630A
Standards		IEC 60269-1 and 2	IEC 60269-1 and 2-1	IEC 60269-1 and 2-1 EN 354701-2-1	IEC 60269-1 and 2-1 EN 354701-2-1
Rated voltage	U_n	690Vac	690Vac	690Vac	690Vac
Rated frequency	f	40-60Hz	40-60Hz	40-60Hz	40-60Hz
Rated insulation voltage	U_i	1000Vac	1000Vac	1000Vac	1000Vac
Fuse link size		000 and 00	1	2	3
Max rated current of the fuse link	I_n	160A	250A	400A	630A
Thermal current/Maximum cable size	I_{th}	240A with neutral link SDL-00/ Cross-section	400A/240mm ² with neutral link SDL-1/ cross-section	560A/185mm ² with neutral link SDL-2/ cross-section	800A/2x185mm ² with neutral link SDL-3/ cross-section
Degree of protection		IP20	IP20	IP20	IP20
Max power losses of the fuse link	P_y	12W	32W	45W	60W
Permissible ambient temperature		-25°C to 55°C	-25°C to 55°C	-25°C to 55°C	-25°C to 55°C

Dimensions (mm) for BFR00-3D-FC

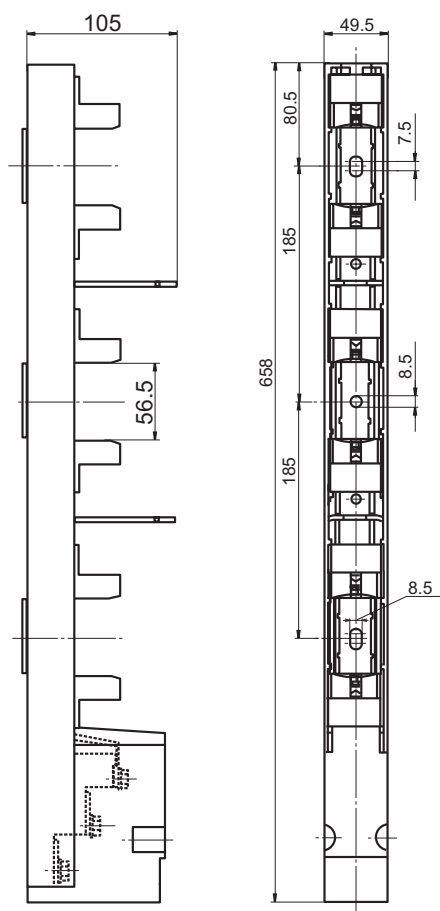

NH Fuse rails - vertical - BFR series

Dimensions (mm) for BFR1, BFR2 and BFR3

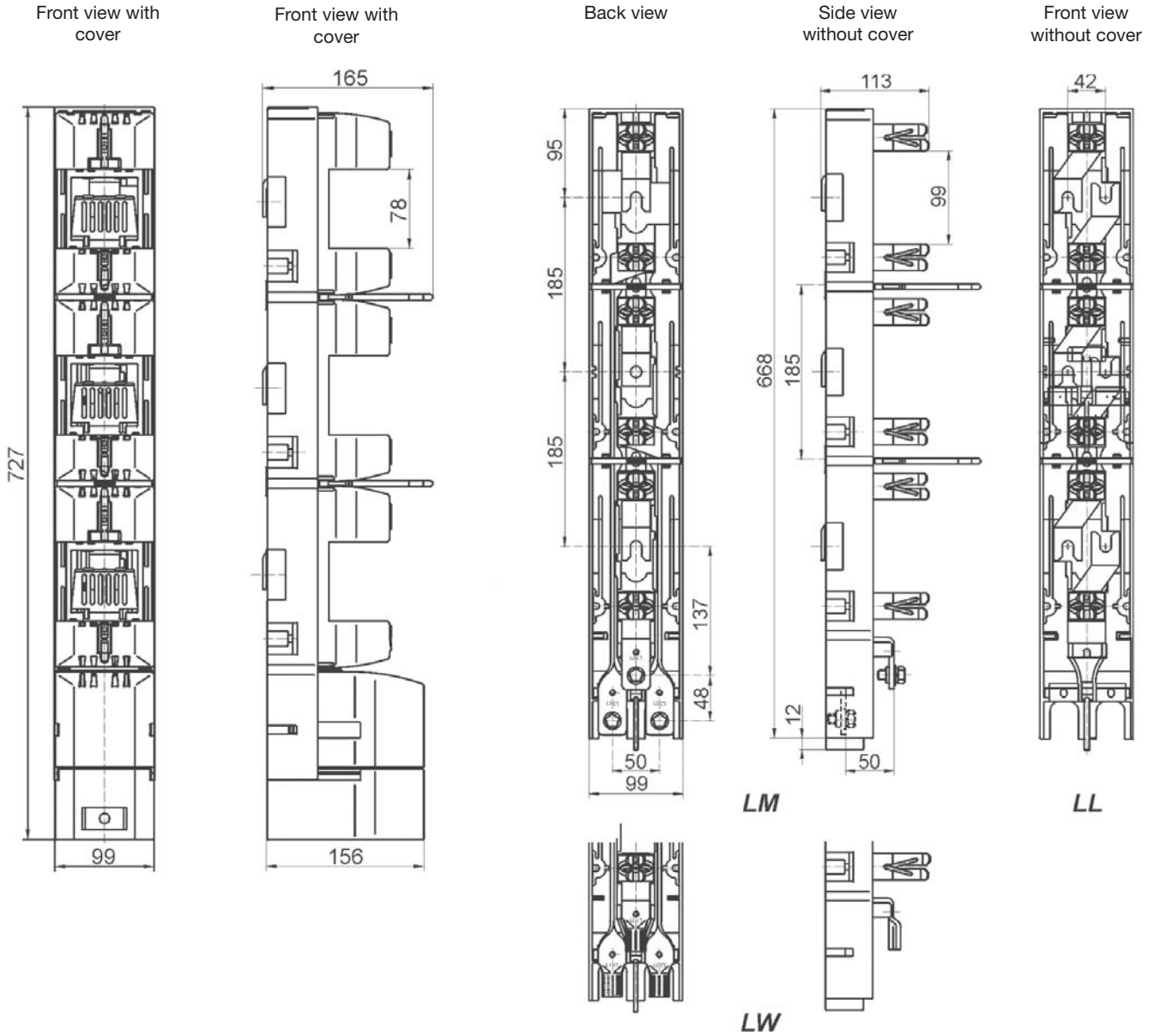

NH Fuse switch disconnectors - vertical - BFD series



Description

Vertical fuse disconnectors designed to be used with NH fuse links, enabling safe connecting and disconnection on load.

Part number structure

BFD00-33D-F: size 00 M8 cable connections

BFD(size)-3(number of poles)-LM: pressed-in nuts with M10 screw

BFD(size)-3(number of poles)-LW:V-shaped clamps

BFD(size)-3(number of poles)-LL: for use on Busbar systems with 185mm spacing. Connects to Busbar with M12 Bolts

Standards/approvals

IEC 60947-1 and 3, and CE

Technical data

- Rated voltage: 690Vac
- Rated current: 160 to 630A
- Utilisation category:
 - AC23B 400Vac Size 00 to 3
 - AC21B 690Vac Size 00
 - AC22B 690Vac Size 1 to 3

Compatible fuse links

- NH 400, 500 and 690V gG and aM fuse links

Packaging:

- 1 per carton

Features:

- Lockable fuse covers.
- Label for circuit identification.
- Busbar mounting.
- Busbar mounting option.

Part numbers

Size	Rated current (Amps)	Part number		Leading out terminals	Unit packing	Compatible fuse links size
		1-pole switching	3-pole switching			
00	160	N/A	BFD00-33D-F	M8 cable connections	1	000 and 00
1	250	BFD1-31-LM	BFD1-33-LM	Pressed-in nuts with M10 screws	1	01 and 1
		BFD1-31-LW	BFD1-33-LW	V-shaped terminals for 5845 clamps*		
		BFD1-31-LL	BFD1-33-LL	For use on Busbar system with 185mm spacing. Connects to Busbar with M12 Bolts		
2	400	BFD2-31-LM	BFD2-33-LM	Pressed-in nuts with M10 screws	1	02 and 2
		BFD2-31-LW	BFD2-33-LW	V-shaped terminals for 5845 clamps*		
		BFD2-31-LL	BFD2-33-LL	For use on Busbar system with 185mm spacing. Connects to Busbar with M12 Bolts		
3	630	BFD3-31-LM	BFD3-33-LM	Pressed-in nuts with M10 screws	1	03 and 3
		BFD3-31-LW	BFD3-33-LW	V-shaped terminals for 5845 clamps*		
		BFD3-31-LL	BFD3-33-LL	For use on Busbar system with 185mm spacing. Connects to Busbar with M12 Bolts		

* The clamps must be ordered separately

NH Fuse switch disconnectors - vertical - BFD series

Technical data

Type		BFD00	BFD1	BFD2	BFD3
Rated current	I_n	160A	250A	400A	630A
Rated voltage	U_n	690Vac	690Vac	690Vac	690Vac
Standards		IEC 60947-1-3 and EN 60947-1-3	IEC 60947-1-3 and EN 60947-1-3	IEC 60947-1-3 and EN 60947-1-3	IEC 60947-1-3 and EN 60947-1-3
Utilisation category	U_n	AC23B at 400Vac and AC21B at 690Vac	AC23B at 400Vac and AC22B at 690Vac	AC23B at 400Vac and AC22B at 690Vac	AC23B at 400Vac and AC22B at 690Vac
Thermal current with fuse links	I_{th}	160A	250A	400A	630A
Thermal current with fuse links (with disconnecting knife)	I_{th}	160A with solid link SDL-00	400A with solid link SDL-1	560A with solid link SDL-2	800A with solid link SDL-3
Rated frequency	f	40-60Hz	40-60Hz	40-60Hz	40-60Hz
Rated insulation voltage	I_{kn}	1000Vac	1000Vac	1000Vac	1000Vac
Conditional short-circuit current with fuse links PN (RMS)		50kA	120kA	120kA - up to 250A 80kA - up to 400A	120kA - up to 250A 80kA - up to 400A 50kA - up to 630A
Impulse withstand voltage	U_{im}	8kV	8kV	8kV	8kV
Fuse link size		000 and 00	1	2	3
Fuse link maximum rated current	I_n	160A	250A	400A	630A
Fuse link maximum power loss	P_v	12W	32W	45W	60W
Power losses at I_n without fuse link	P_v	10W	16W	35W	65W
Electrical durability		200	200	200	200
Mechanical durability		1700	1400	800	800
Degree of protection from front side, built-in device, cover closed		IP30	IP20	IP20	IP20
Degree of protection from front side, built-in device, cover opened		IP20	IP20	IP20	IP20
Permissible ambient temperature		-25°C to 55°C	-25°C to 55°C	-25°C to 55°C	-25°C to 55°C
Altitude above sea level		max 2000m	max 2000m	max 2000m	max 2000m
Overvoltage category for 690Vac		IV	III	III	III
Seismic resistance acc to VDE skoda		3g/8 to 50Hz	1.5g/8 to 50Hz	1.5g/8 to 50Hz	1.5g/8 to 50Hz

NH Fuse switch disconnectors - vertical - BFD series

Dimensions (mm) for BFD00-33D-F

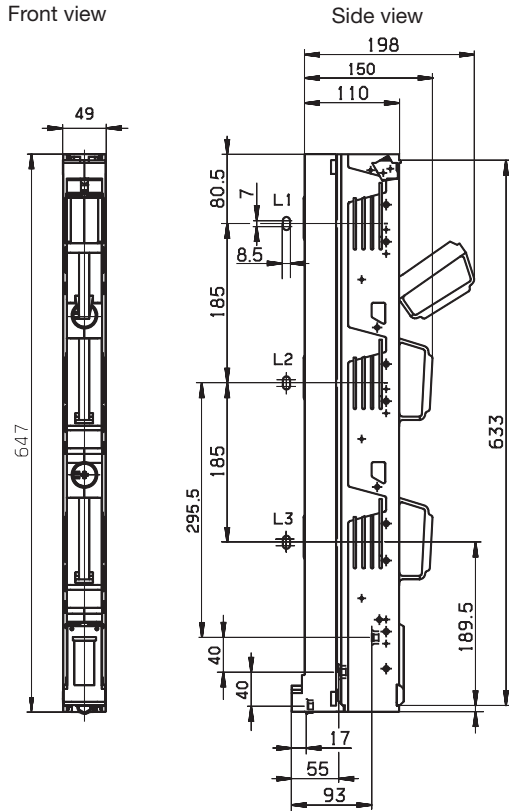

Dimensions (mm) for BF1, BFD2 and BFD3

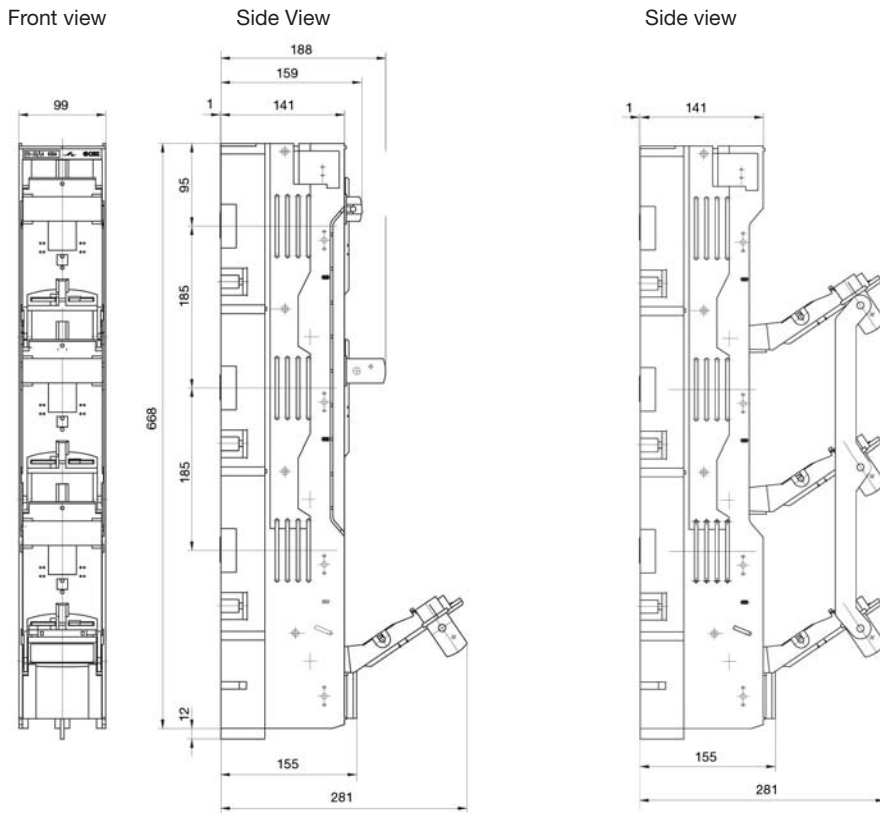

Accessories

NH Fuse switch disconnectors - horizontal - BFH series



Description

Horizontal fuse switch disconnectors designed to be used with NH fuse links, enabling safe connection and disconnection on load.

Part number structure

BFH000-(1 or 3-pole)A-T: size 000 fitted with terminal clips for 1.5 to 50mm² cable

BFH00-(1 or 3-pole)A-F: size 00 fitted with M8 terminal screw

BFH(size 1 or 2)-(1 or 3-pole)A-F: size 1 or 2 fitted with M10 terminal screw

BFH3-(1 or 3-pole)A-F: size 3 fitted with M12 terminal screw

Standards/approvals

IEC 60947-1 and 3, and CE

Technical data

- Rated voltage:
 - 690Vac/250Vdc size 1 to 3
 - 400Vdc size 000 and 00
- Rated current:
 - 160 to 630A
- Utilisation category:
 - AC23B 400Vac
 - AC22B 500Vac
 - AC21B 690Vac
 - DC21B 250Vdc (size 1 to 3)
 - DC22B 250Vdc (size 000 and 00)

Compatible fuse links

- NH 400, 500 and 690V NH gG and aM fuse links

Packaging:

- 1 per carton

Features:

- Lockable fuse covers.
- Label for protected circuit identification.
- Busbar mounting with screws.
- Panel mounting with screws (size 000 can be DIN-Rail mounted)

Part Numbers

Size	Rated current (Amps)	Part number		Leading out terminals	Unit packing	Compatible fuse links size
		1-pole switching	3-pole switching			
000	160	BFH000-1A-T	BFH000-3A-T	Terminal clamps for 1.5 to 50mm ² cable	1	000
00	160	BFH00-1A-F	BFH00-3A-F	Terminal screws M8		00
1	250	BFH1-1A-F	BFH1-3A-F	Terminal screws M10		1
2	400	BFH2-1A-F	BFH2-3A-F	Terminal screws M10		2
3	630	BFH3-1A-F	BFH3-3A-F	Terminal screws M10		3

NH Fuse switch disconnectors - horizontal - BFH series

Technical data

Type		BFH000 and BFH00	BFH1	BFH2	BFH3
Rated voltage	U_n	690Vac	690Vac/250Vdc	690Vac/250Vdc	690Vac/250Vdc
Rated current	I_n	160A	250A	400A	630A
Utilisation category		AC23B at 400Vac AC22B at 500Vac AC21B at 690Vac DC22B at 250Vdc DC20B at 440Vdc	AC23B at 400Vac AC22B at 500Vac AC21B at 690Vac AC22B at 690Vac/200A DC21B at 440Vdc	AC23B at 500Vac for BFH2-3 AC23B at 400Vac for BFH2-1 AC22B at 690Vac DC21B at 250Vdc	AC23B at 500Vac for BFH3-F AC23B at 400Vac for BFH3-1-F AC22B at 690Vac DC21B at 250Vdc
Thermal current with fuse links	I_{th}	160A	250A	400A	630A
Thermal current with fuse links with disconnecting knife		240A (size 000) and 250A (size 00) with solid link SDL-00	325A with solid link SDL-1	520A with solid link SDL-2	750A with solid link SDL-3
Rated frequency	f	40-60Hz	40-60Hz	40-60Hz	40-60Hz
Rated insulation voltage	U_i	800Vac (size 000) 1000Vac (size 00)	1000Vac	1000Vac	1000Vac
Conditional short circuit current (RMS)	I_{kn}	120kA for 400Vac/160A 120kA for 500Vac/100A 80kA for 690Vac/100A	120kA for 400Vac/250A 50kA for 500Vac/250A min 25kA for 690Vac/250A	120kA for 400Vac/250A 50kA for 500Vac/250A min 25kA for 690Vac/250A	120kA for 400Vac/630A 50kA for 500Vac/630A min 25kA for 690Vac/630A
Impulse withstand voltage	U_{imp}	8kV for BFH000-A-T	12kV for BFH1-A-F	12kV for BFH2-A-F	12kV for BFH3-A-F
Fuse link size		000 and 00	1	2	3
Max power losses of the fuse link	P_v	9W (size 000) 12W (size 00)	23W	34W	48W
Max power at I_n without fuse link	P_v	7W	9W	23W	49W
Electrical durability (operating cycle)		300 at 100A 200 at 160A	200 at 250A	200 at 400A	200 at 630A
Mechanical durability (operating cycle)		2000	1400	800	800
Degree of protection from front side, built-in device, cover closed (measuring holes filled)		IP30 (size 000) IP20 (size 00)	IP30	IP30	IP30
Degree of protection from front side, built-in device, cover opened		IP20	IP20	IP20	IP20
Permissible ambient temperature		-25°C to 55°C	-25°C to 55°C	-25°C to 55°C	-25°C to 55°C
Altitude above sea level		max 2000m	max 2000m	max 2000m	max 2000m
Pollution degree		3	3	3	3
Overvoltage category for 690Vac		III (size 000) IV (size 00)	IV	IV	IV
Seismic resistance		0.25 to 50Hz/3g	0.25 to 50Hz/3g	0.25 to 50Hz/3g	0.25 to 50Hz/3g
Torque of outlets terminals		3 to 3.5Nm (size 000)			
Standards		IEC 60947-1, 3	IEC 60947-1, 3	IEC 60947-1, 3	IEC 60947-1, 3

NH Fuse switch disconnectors - horizontal - BFH series

Dimensions (mm) for BFH000

Side view

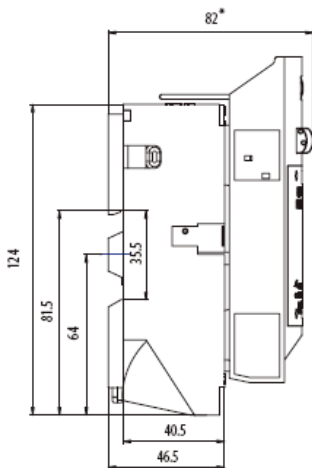

In open position

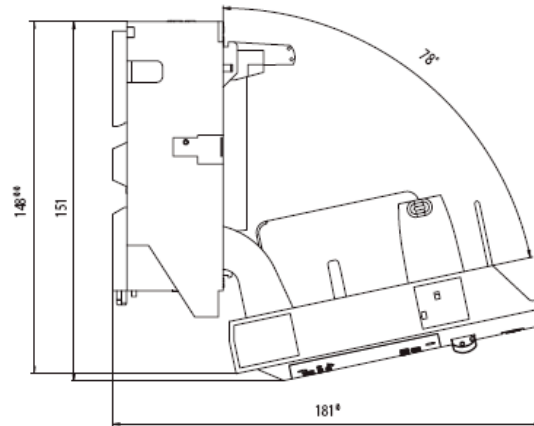

Clearance and drill plans for 1-pole, for 3-pole multiply by 3

1 - pole

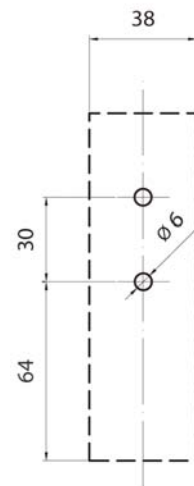

Dimensions (mm) for BFH00

Side view

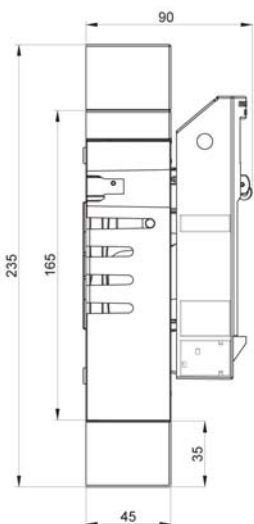

In open position

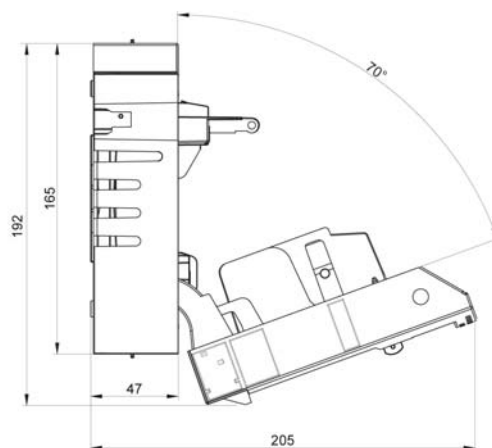

Clearance and drill plans for 1-pole, for 3-pole multiply by 3

1 - pole

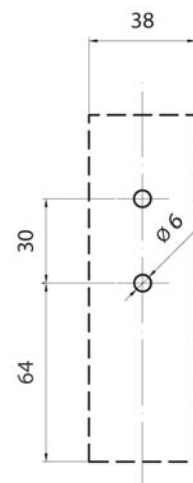

NH Fuse switch disconnectors - horizontal - BFH series

Dimensions (mm) for BFH1

Side view

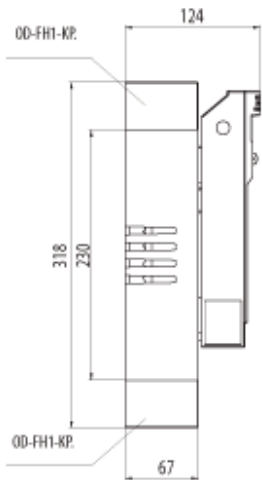

In open position

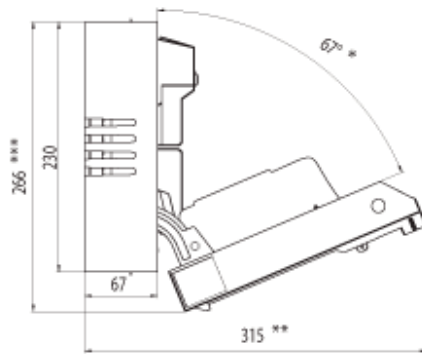

Clearance and drill plans for 1-pole, for 3-pole multiply by 3

1 - pole

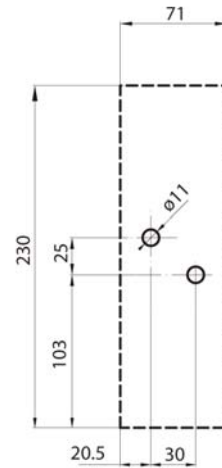

Dimensions (mm) for BFH2

Side view

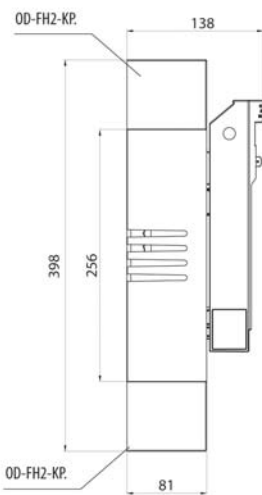

In open position

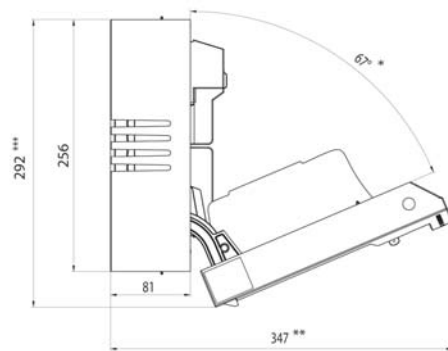

Clearance and drill plans for 1-pole, for 3-pole multiply by 3

1 - pole

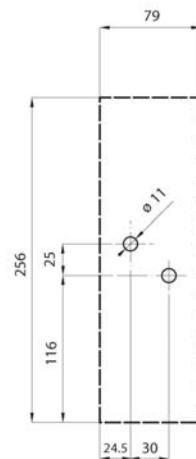

NH Fuse switch disconnectors - horizontal - BFH series

Dimensions (mm) for BFH3

Side view

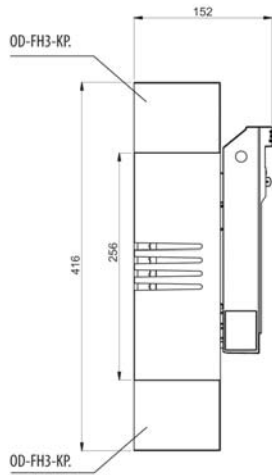

In open position

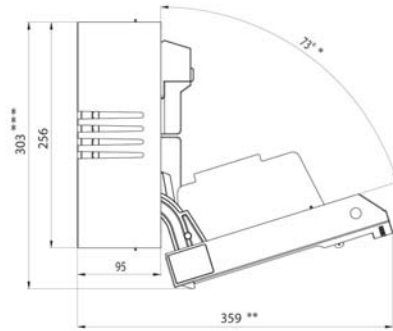

Clearance and drill plans for
1-pole, for 3-pole multiply by 3

1 - pole

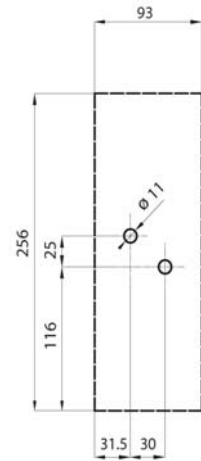

Index by part numbers

Part Number	Size	Voltage	Class	Type	Page
170H0236	N/A	250	N/A	Microswitch	49
170H0238	N/A	250	N/A	Microswitch	49
BFD	00-3	690	N/A	Fuse disconnecter	56 - 58
BFH	N/A	400-690	N/A	Fuse disconnecter	59 - 63
BFR	00-3	690	N/A	Fuse rail	53 - 55
BVL50	N/A	250	N/A	Microswitch	49
FEH	00-3	N/A	N/A	Fuse extraction handle	52
NHG000B	000	500	gG	Fuse - Metal	22
NHG000B-400	000	400	gG	Fuse - Metal	14
NHG000B-690	000	690	gG	Fuse - Metal	34
NHG000BI	000	500	gG	Fuse - IMGL	22
NHG000BI-400	000	400	gG	Fuse - IMGL	14
NHG00B	00	500	gG	Fuse - Metal	23
NHG00B-400	00	400	gG	Fuse - Metal	15
NHG00B-690	00	690	gG	Fuse - Metal	35
NHG00BI	00	500	gG	Fuse - IMGL	23
NHG00BI-400	00	400	gG	Fuse - IMGL	15
NHG01B	01	500	gG	Fuse - IMGL	25
NHG01B-400	01	400	gG	Fuse - Metal	16
NHG01BI	01	500	gG	Fuse - IMGL	25
NHG01BI-400	01	400	gG	Fuse - IMGL	16
NHG02B	02	500	gG	Fuse - Metal	27
NHG02B-400	02	400	gG	Fuse - Metal	17
NHG02BI	02	500	gG	Fuse - IMGL	27
NHG02BI-400	02	400	gG	Fuse - IMGL	17
NHG03B	03	500	gG	Fuse - Metal	29
NHG03B-400	03	400	gG	Fuse - Metal	18
NHG03BI	03	500	gG	Fuse - IMGL	29
NHG03BI-400	03	400	gG	Fuse - IMGL	18
NHG0B	0	500	gG	Fuse - Metal	24
NHG0BI	0	500	gG	Fuse - IMGL	24
NHG1B	1	500	gG	Fuse - Metal	26
NHG1B-400	1	400	gG	Fuse - Metal	16
NHG1B-690	1	690	gG	Fuse - Metal	36
NHG1BI	1	500	gG	Fuse - IMGL	26
NHG1BI-400	1	400	gG	Fuse - IMGL	16
NHG2B	2	500	gG	Fuse - Metal	28
NHG2B-400	2	400	gG	Fuse - Metal	17
NHG2B-690	2	690	gG	Fuse - Metal	37
NHG2BI	2	500	gG	Fuse - IMGL	28
NHG2BI-400	2	400	gG	Fuse - IMGL	17
NHG3B	3	500	gG	Fuse - Metal	30
NHG3B-400	3	400	gG	Fuse - Metal	18
NHG3B-690	3	690	gG	Fuse - Metal	38
NHG3BI-400	3	400	gG	Fuse - IMGL	18
NHG4B-690	4	690	gG	Fuse - Metal	39
NHG4G	4	500	gG	Fuse - Metal	31
NHM000B	000	500	aM	Fuse - Metal	42
NHM000B-690	000	690	aM	Fuse - Metal	42
NHM00B	00	500	aM	Fuse - Metal	43
NHM00B-690	00	690	aM	Fuse - Metal	43
NHM1B	1	500	aM	Fuse - Metal	44
NHM1B-690	1	690	aM	Fuse - Metal	44
NHM2B	2	500	aM	Fuse - Metal	45
NHM2B-690	2	690	aM	Fuse - Metal	45
NHM3B	3	500	aM	Fuse - Metal	46
NHM3B-690	3	690	aM	Fuse - Metal	46
SD-D	00-3	690	N/A	NH base	47 - 51
SD-S	00-4	690	N/A	NH base	47-51
SDL	00-3	N/A	N/A	Neutral links	48
SD-PB	00-3	N/A	N/A	Protection accessories	49
SD-SK	1-3	N/A	N/A	Shroud kits	48
TD-D	00-3	690	N/A	NH base	47-51
TD-IP20	00-3	N/A	N/A	IP Protection kit	49

IMGL: Insulated Metal Gripping Lugs

Index by size

Size	Voltage	Part Number	Class	Type	Page
0	500	NHG0BI	gG	Fuse - IMGL	24
0	500	NHG0B	gG	Fuse - Metal	24
00	400	NHG00BI-400	gG	Fuse - IMGL	15
00	400	NHG00B-400	gG	Fuse - Metal	15
00	500	NHG00BI	gG	Fuse - IMGL	23
00	500	NHG00B	gG	Fuse - Metal	23
00	500	NHM00B	aM	Fuse - Metal	43
00	690	NHG00B-690	gG	Fuse - Metal	35
00	690	NHM00B-690	aM	Fuse - Metal	43
000	400	NHG000BI-400	gG	Fuse - IMGL	14
000	400	NHG000B-400	gG	Fuse - Metal	14
000	500	NHG000BI	gG	Fuse - IMGL	22
000	500	NHG000B	gG	Fuse - Metal	22
000	500	NHM000B	aM	Fuse - Metal	42
000	690	NHG000B-690	gG	Fuse - Metal	34
000	690	NHM000B-690	aM	Fuse - Metal	42
00-3	690	BFD	N/A	Fuse disconnectors	56 - 58
00-3	690	BFR	N/A	Fuse rail	53 - 55
00-3	690	SD-D	N/A	NH base	47 - 51
00-3	690	TD-D	N/A	NH base	47-51
00-3	N/A	FEH	N/A	Fuse extraction handle	52
00-3	N/A	TD-IP20	N/A	IP Protection kit	49
00-3	N/A	SDL	N/A	Neutral links	48
00-3	N/A	SD-PB	N/A	Protection accessories	49
00-4	690	SD-S	N/A	NH base	47-51
01	400	NHG01BI-400	gG	Fuse - IMGL	16
01	400	NHG01B-400	gG	Fuse - Metal	16
01	500	NHG01B	gG	Fuse - IMGL	25
01	500	NHG01BI	gG	Fuse - IMGL	25
02	400	NHG02BI-400	gG	Fuse - IMGL	17
02	400	NHG02B-400	gG	Fuse - Metal	17
02	500	NHG02BI	gG	Fuse - IMGL	27
02	500	NHG02B	gG	Fuse - Metal	27
03	400	NHG03BI-400	gG	Fuse - IMGL	18
03	400	NHG03B-400	gG	Fuse - Metal	18
03	500	NHG03BI	gG	Fuse - IMGL	29
03	500	NHG03B	gG	Fuse - Metal	29
1	400	NHG1BI-400	gG	Fuse - IMGL	16
1	400	NHG1B-400	gG	Fuse - Metal	16
1	500	NHG1BI	gG	Fuse - IMGL	26
1	500	NHG1B	gG	Fuse - Metal	26
1	500	NHM1B	aM	Fuse - Metal	44
1	690	NHG1B-690	gG	Fuse - Metal	36
1	690	NHM1B-690	aM	Fuse - Metal	44
1-3	N/A	SD-SK	N/A	Shroud kits	48
2	400	NHG2BI-400	gG	Fuse - IMGL	17
2	400	NHG2B-400	gG	Fuse - Metal	17
2	500	NHG2BI	gG	Fuse - IMGL	28
2	500	NHG2B	gG	Fuse - Metal	28
2	500	NHM2B	aM	Fuse - Metal	45
2	690	NHG2B-690	gG	Fuse - Metal	37
2	690	NHM2B-690	aM	Fuse - Metal	45
3	400	NHG3BI-400	gG	Fuse - IMGL	18
3	400	NHG3B-400	gG	Fuse - Metal	18
3	500	NHG3B	gG	Fuse - Metal	30
3	500	NHM3B	aM	Fuse - Metal	46
3	690	NHG3B-690	gG	Fuse - Metal	38
3	690	NHM3B-690	aM	Fuse - Metal	46
4	500	NHG4G	gG	Fuse - Metal	31
4	690	NHG4B-690	gG	Fuse - Metal	39
N/A	250	170H0236	N/A	Microswitch	49
N/A	250	170H0238	N/A	Microswitch	49
N/A	250	BVL50	N/A	Microswitch	49
N/A	400-690	BFH	N/A	Fuse disconnectors	59 - 63

IMGL: Insulated Metal Gripping Lugs

Customer satisfaction team

Bussmann's Customer Satisfaction Team is available to answer questions regarding Bussmann products.

Europe calls can be made between:

Monday - Thursday 7.30 a.m. - 5.30 p.m. GMT

Friday 7.30 a.m. - 5.00 p.m. GMT

The Customer Service Satisfaction Team can be reached via:

- Phone: 00 44 (0) 1509 882 600
- Fax: 00 44 (0) 1509 882 786
- Email: bulesales@eaton.com

C3 customer center

The C3 portal supports the following Divisions: B-Line, Bussmann, Crouse-Hinds, Cooper Lighting, Cooper Power Systems, Cooper Safety, and Cooper Wiring Devices.

Get started today at www.cooperc3.com by clicking 'Request User ID and Password'.

- Easy to Navigate
- Simple to Use
- Real-Time Data

Online resources

Visit www.bussmann.com for the following resources:

- Product cross reference
- Product profiles
- Online catalogues for the latest United States and European catalogues

Application engineering

Application Engineering assistance is available to all customers. The Application Engineering team is staffed by university-qualified electrical engineers who are available with technical and application support.

Europe calls can be made between:

Monday - Thursday 8.30 a.m. - 4.30 p.m. GMT

Friday 8.30 a.m. - 4.00 p.m. GMT

Application Engineering can be reached via:

- Phone: 00 44 (0) 1509 882 699
- Fax: 00 44 (0) 1509 882 794
- Email: buletechnical@eaton.com

Eaton is dedicated to ensuring that reliable, efficient and safe power is available when it's needed most. With unparalleled knowledge of electrical power management across industries, experts at Eaton deliver customised, integrated solutions to solve our customers' most critical challenges.

Our focus is on delivering the right solution for the application. But, decision makers demand more than just innovative products. They turn to Eaton for an unwavering commitment to personal support that makes customer success a top priority.

For more information, visit www.eaton.com/electrical

Eaton
Cooper Bussmann (UK) Ltd
Melton Road
Burton-on-the-Wolds
LE12 5TH
Leicestershire
United Kingdom

Eaton Industries Manufacturing GmbH
EMEA Headquarters
Route de la Longeraie
1110 Morges
Switzerland
Eaton.eu

© 2013 Eaton Industries
All rights reserved
Printed in the United Kingdom
Publication No. NHCATALOGUE1113
November 2013

Changes to the products, to the information contained in this document, and to prices are reserved; so are errors and omissions. Only order confirmations and technical documentation by Eaton is binding. Photos and pictures also do not warrant a specific layout or functionality. Their use in whatever form is subject to prior approval by Eaton. The same applies to Trademarks (especially Eaton, Moeller, and Cutler-Hammer). The Terms and Conditions of Eaton apply, as referenced on Eaton Internet pages and Eaton order confirmations.

Eaton is a registered trademark.

All other trademarks are property of their respective owners.



Powering Business Worldwide