

Bussmann MV fuse links

Medium voltage fuse links

Full line catalogue



Bussmann
by **EAT•N**



Energizing a world that demands more.



Discover today's Eaton.

Powering business worldwide

As a global power management company, we help customers worldwide manage the power needed for buildings, aircraft, trucks, cars, machinery and businesses.

Eaton's innovative technologies help customers manage electrical, hydraulic and mechanical power more reliably, efficiently, safely and sustainably.



EATON

Powering Business Worldwide



We deliver:

- **Electrical solutions** that use less energy, improve power reliability and make the places we live and work safer and more comfortable
- **Hydraulic and electrical solutions** that enable machines to deliver more productivity without wasting power
- **Aerospace solutions** that make aircraft lighter, safer and less costly to operate, and help airports operate more efficiently
- **Vehicle drivetrain and powertrain solutions** that deliver more power to cars, trucks and buses, while reducing fuel consumption and emissions

We provide integrated solutions that help make energy, in all its forms, more practical and accessible.

With 2013 sales of \$22 billion, Eaton has approximately 100,000 employees around the world and sells products in more than 175 countries.



Eaton's electrical business

Eaton is a global leader with expertise in:

- Power distribution and circuit protection
- Backup power protection
- Solutions for harsh and hazardous environments
- Lighting and security
- Structural solutions and wiring devices
- Control and automation
- Engineering services

Eaton is positioned through its global solutions to answer today's most critical electrical power management challenges. With 100 years of electrical experience behind us, we're energized by the challenge of powering up a world that demands twice as much energy as today. We're anticipating needs, engineering products and creating solutions to energize our markets today and in the future.

We are dedicated to ensuring that reliable, efficient and safe power is available when it's needed most.

Eaton.com

Company overview

Bussmann, a division of Eaton, is the leading source of circuit protection solutions in the global marketplace. Bussmann products are approved for use around the world and meet agency requirements and international standards: IEC, VDE, DIN, UL, CSA, BS and others.

Bussmann global headquarters are in St Louis, Missouri (US) and the European headquarters are in Burton-on-the-Wolds, Leicestershire (UK).

Bussmann manufactures over 50,000 Part numbers covering extensive circuit protection solutions for a wide range of applications: residential, industrial, motor protection, power conversion, distribution, telecommunications and automotive.

Bussmann has been a leading exponent in the design, development and manufacture of medium voltage fuse links and their associated accessories for more than 90 years and has supplied fuse links to more than 90 countries worldwide.

Bussmann team of specialist engineers plays a leading role in international standardisation of medium voltage fuse links, offering comprehensive advice on selection and applications.

With a continual commitment to meet our customers' needs with innovative high quality products with ISO 9002 'approval systems,' Bussmann is the supplier of choice for medium voltage circuit protection solutions, today.



Contents

Introduction to medium voltage fuse link technology	6
How to order	8
DIN Fuse links	9
Motor fuse links	24
Auxiliary transformer fuse links	34
Oil fuse links	54
British standard air fuse links	62
US Style E-Rated fuse links	74
Fuse clips	92
Expulsion fuse links	93
ASL - Automatic Sectionalising Links	95
Boric acid fuse links	99
Cross references	106
DIN Fuse links	106
Motor fuse links	108
Voltage and auxiliary transformer fuse links	108
Oil fuse links	109
British standard air fuse links	110
US Style E-Rated fuse links	111
Boric acid fuse links	116
Time current curves and cut-off curves list	117
Index	119

Introduction to medium voltage fuse link technology

Offering unparalleled short-circuit interruption capabilities, Medium Voltage (MV) current-limiting fuse links are the principle protection device used by electrical utilities and switchgear manufacturers throughout the world.

Safe, reliable, environmentally friendly and cost effective, MV Fuse links are the protection device of choice for distribution circuits due to their speed of operation and current limiting ability in the event of a short-circuit fault.

The diagram below shows the operation of a fuse link interrupting a short-circuit fault, achieving a current zero well within the first half-cycle of a fault. Energy let-through into the site of a fault may be typically only 1/500th of that of any other type of switching device.

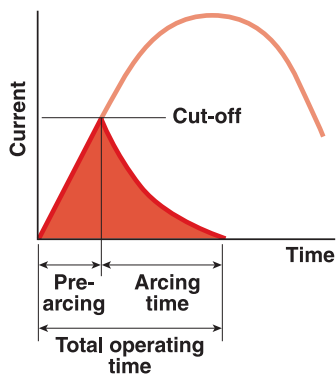
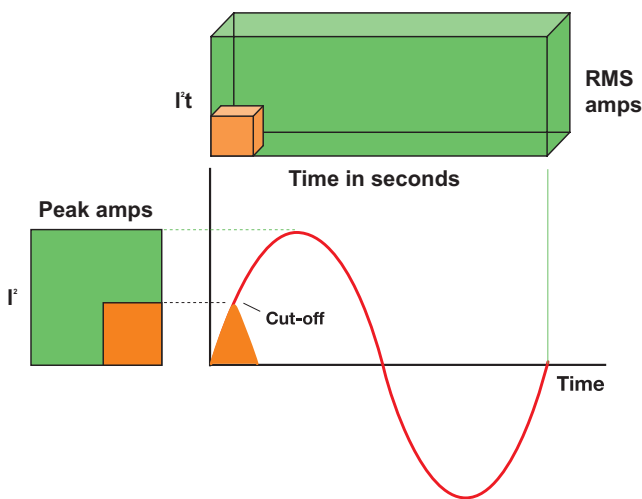

The speed of operation reduces the effect of short-circuit currents, dramatically limiting the energy delivered to the faulted circuit, preventing the catastrophic results of high faults and disturbing voltage arcs. The fuse link operation significantly limits the arc-flash hazard at the fault location. Improved power supply quality also results from the use of fuse links. High fault currents are interrupted in a few milliseconds, minimising voltage dips in system supply voltage.

The main standard covering Medium voltage (MV) fuse links is IEC 60282-1, 2009. IEC defines MV as from 1 kV to 72.5 kV.

Current-limiting MV Fuse links, split into three internationally recognised types: **back-up** (or sometimes called partial range), fuse links, which will interrupt any current from their rated Breaking capacity down to a Minimum breaking current, specified by the manufacturer. **General purpose** MV Fuse links will interrupt all currents that will melt the elements within one hour. **Full range** MV Fuse links can interrupt any current below the rated Breaking capacity that melts the fuse elements satisfactorily.

The diagram below illustrates the three performance criteria in terms of their Minimum breaking current I_b .

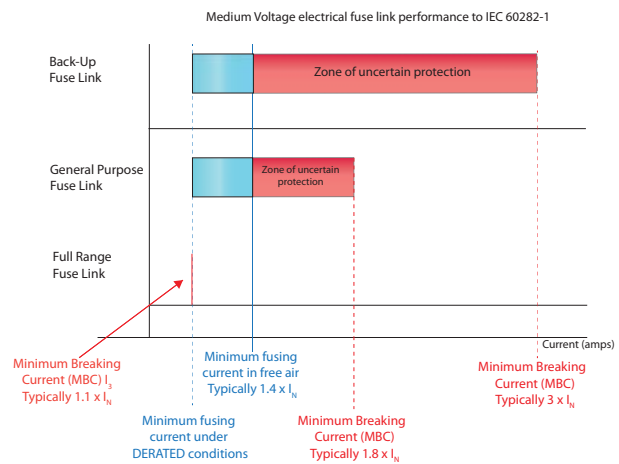

Current-limiting MV Fuse links are similar in construction to Low voltage (LV) cartridge types. Fuse elements do need to be much longer however to safely interrupt a medium voltage short-circuit. This is achieved by winding the elements round an internal core or holder, often called a star-core or spider; using this technique a one metre length element can be accommodated in a 250 mm length body. The elements are surrounded by a pure, highly compacted granular quartz filler.

Like a LV fuse link, a MV Fuse link has a ceramic body. Most current-limiting MV Fuse links are also fitted with a striker mechanism. This is used to operate the trip bar or mechanism in a fuse-switch combination, fuse-switch or ring main unit (RMU) to achieve low overload fault interruption and three-phase disconnection.

Typically striker mechanisms are driven by a spring mechanism, triggered by a thin striker wire or striker coil running the length of the fuse link, connected in parallel to the fuse link elements. The striker coil is of much higher resistance than the fuse link elements, so a current only flows through the striker coil when the fuse link elements melt. The current heats up the striker coil and this in turn melts the wire retaining the spring, releasing it and pushing out the striker.

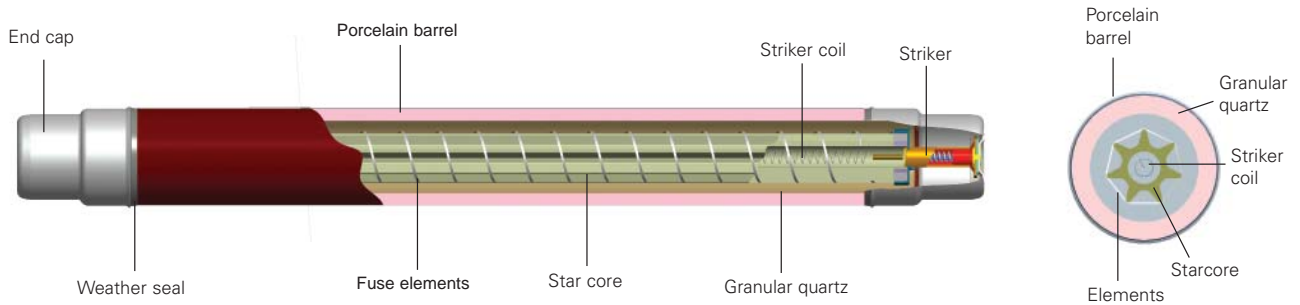

Non-current limiting

Essentially, non-current limiting fuse links have short elements and incorporate some means of lengthening the arc after the element melts, extinguishing the arc and preventing re-ignition. These are known as expulsion fuse links.

Expulsion fuse links are an effective way of protecting overhead distribution lines and transformers. They are designed for outdoor use only and comprise a tin or copper fuse element in series with a flexible braid in a tube. The tube forms one side of a triangle, with a latched connection at the top and a hinge at the bottom. The braid emerges from one end of the fuse link and is held in tension by a spring downwards under gravity. Under fault conditions, the fuse link swings downwards, the arc is lengthened, extinguished and prevented from restriking.

Thermal effects of low overload faults

During overload faults lasting a long time, it is possible for medium voltage (MV) elements to get very hot prior to actually melting. Given that silver has a melting temperature of 960°C, for fuse links with no temperature limitation, this can result in a fuse barrel temperature of over 400°C and 180°C at the insulating surface surrounding the fuse. To prevent deterioration of the insulation and to the fuse link itself, all MV Fuse links should incorporate some form of technology to limit the thermal stress- heating, that is possible under prolonged low overload faults, often referred to as temperature limiting technology.

Since the launch of its first MV Fuse links almost half a century ago, Bussmann has employed M-effect technology to achieve temperature limitation throughout its MV Fuse link range. A small mass of special low melting point alloy is added to each fuse element, this has the effect of drastically reducing the temperature of the MV Fuse link during operation. The larger cross section of the fuse link elements, made possible by use of this feature, ensures cooler running and lower power dissipation under normal service conditions than comparable temperature limitation technology.

Other manufacturers employ a temperature-limiting (or thermal) striker to overcome their overheating problems. In general with this approach the maximum temperatures reached by the fuse link and its surrounding insulation are not as low as with the use of M-effect. Such a solution is no more effective than use of M-effect on the fuse link elements and moreover does not bring the additional advantages of lower watts loss, cooler running and greater withstand against transient surge currents.

When a Bussmann fuse link operates under low overload fault conditions the maximum temperature rise of the fuse link is such that the temperature of the surrounding synthetic insulation remains below the temperature limits for all insulated fuse switchgear. The fuse barrel therefore remains intact and the fuse carrier and its contacts remain unimpaired.

Typically a Bussmann MV Fuse link of a given rating may run 10-30°C cooler than comparable fuse links which do not employ

M-effect. This advantage is particularly useful when the MV Fuse link is used in totally enclosed all insulated switchgear, such as cast resin fuse-switches or compact SF6 insulated Ring Main Units (RMUs), or GIS HV switchgear, since less derating is required and hence a smaller rating of MV Fuse link will do the same job as a higher rated MV Fuse link from another manufacturer.

In short M-effect fuse links are generally safer, give better protection and are longer lasting than alternative designs, which do not employ these valuable features.

GLOSSARY FOR MEDIUM VOLTAGE FUSE LINKS

The following is a brief introduction to medium voltage fuse link technology. Some of the terms are also used in other areas of fuse technology.

Current rating/Current, I_n - The current of the fuse link, given in amps.

- Derating - A reference to the fact that all MV Fuse links must be derated once they are placed in a confined space, for example when mounted in switchgear. The fuse link must be derated to take into account the effect of heating on element resistance. Typically a fuse link is derated by between 5-20% depending on application.
- Test Duty, TD - A term used to refer to a specific type test within the IEC standard. Test Duty one (TD1), short-circuit test, Test Duty two (TD2), maximum arc energy test and Test Duty three (TD3), low overcurrent test.
- Minimum Breaking capacity Current, MBC, I_3 - The minimum current the fuse link can interrupt safely, without assistance from switchgear with instantaneous striker tripping.
- Minimum Fusing Current (MFC) - The minimum current which will cause the fuse link elements to start to melt.
- I^2T - The minimum value of pre-arcing and maximum value of total clearing energy a fuse link will allow to pass through it during short circuit operation, expressed as an amount of current (I^2), multiplied by time in seconds.
- Watts loss - The power dissipation of the fuse link at a stated value of load current.
- Breaking capacity, I_1 - The maximum short circuit current the fuse link has been tested to in accordance with test Duty one (TD1), expressed in kA.
- Resistance - The resistance of the fuse link in free air at (20°C), measured in mΩ.

How to order

- 1 — Voltage
- 2 — Type designation letter
- 3 — Barrel diameter
- 4 — Barrel length
- 5 — Striker information *
- 6 — Tag information
- * S = Spring striker 50N
- * E = Spring striker 80N
- * N = No striker fitted
- * H or M = Pyrotechnic striker

Ordering key							
Symbol							
1	2	3	4	5	6	7	Meaning
X							Voltage of the fuse link in kV
	X						The type of fuse link given by a single letter
		X					Diameter of the fuse link barrel (in mm) denoted by a letter
			X				Length of the fuse link barrel (in mm) denoted by a letter
				X			Striker information: type of striker is denoted by a letter *
					X		Tag information: type denoted by a letter
						X	Current rating of the fuse link given in amperes

Example: 12TDLEJ50

Part numbers **12TDLEJ50** represents an outdoor DIN Fuse rated at **12 kV** for use in **Air (T)** with a body diameter of **50.8mm (D)**, a barrel length of **292mm (L)**, a striker to DIN 43625 **80N (E)**, a tag arrangement to **DIN 43625 (J)** and an Amp rating of **50A**.

Ordering code information	Type designation
Voltage of the fuse link	12
Type of fuse link	T
Body diameter	D
Body length	L
Type of striker	E
Type of tag	J
Current rating	50
Complete part numbers	12 T D L E J 50

Parts referencing system

kV	1 st Letter general type	2 nd Letter barrel diameter (mm)	3 rd Letter barrel length (mm)	4 th Letter striker (mm)	5 th /6 th letter and or digit — termination or fixing	Amps A
	A, B, D, N = fuse links for use in air V, W = fuse links primarily for use in motor circuits F = fuse links with Full range characteristics O = fuse links sealed for use in oil switches T = DIN Outdoor range	M = 20.6 B = 25.4 D = 50.8 E, H, L = 63.5 F, I, K = 76.2 X = 88	U = 86 W = 142 O = 192 C = 195 D = 203 F = 254 L = 292 G = 359 N = 403 M = 442 Q = 537 I = 565 K = 914	S = Striker to DIN 43625, form C 50N E = Striker to DIN 43625, 80N H, M = Striker to BS 2692-1 N = None fitted	A = No Tags. Ferrule diameter as the 2nd letter B = Offset tag, single bolt fixing C, D = Tags to BS2692-1 F = Offset tag, double bolt fixing J = Ferrule to DIN 43625 O = Tags to BS 2692-1 6 = Tags to BS 2692-1 22 = 5/16-BSW stud one end only 02, 03 = Double and triple barrel fuse link F2, F3 = Double and triple barrel fuse link	

Note: Most of these fuse types are suitable for outdoor use. A variety of alternative tag arrangements are also available, details on request from Bussmann application engineers buletechnical@eaton.com.

DIN Medium voltage fuse links



Introduction to DIN Medium voltage fuse links	10
Features and benefits	11
General guide to the selection of DIN Fuse links	12
3.6 kV 'A' and 'W' Range current limiting back-up fuse links	14
7.2 kV 'T' Range current limiting back-up fuse links	15
12 kV 'F' Range current limiting full range fuse links	16
12 kV 'A' and 'T' Range current limiting back-up fuse links	17
17.5 kV 'A' and 'T' Range current limiting back-up fuse links	18
24 kV 'F' Range current limiting full range fuse links	20
24 kV 'A' and 'T' Range current limiting back-up fuse links	21
36 kV 'T' Range current limiting back-up fuse links	22
Striker force diagrams	23

Introduction to DIN Medium voltage fuse links

- Fuse links comply with DIN Dimensional standard DIN 43625.
- 'F' Range, high performance full range fuse links.
- 'T' Range, high performance back-up fuse links, with striker tripping.
- 'A' Range, including high current rating back-up fuse link.
- Comply with IEC 60282-1 and VDE 0670 part 4.
- Wide variety of ratings, 3.6 kV to 36 kV.
- 'T' Range is suitable for outdoor use.
- Motor circuit fuse link option, see motor fuse links section page 24.



Bussmann 'T' Range

The Bussmann 'T' range medium voltage current-limiting fuse links to dimensional standard DIN 43625, are one of the most advanced design of medium voltage fuse links available anywhere in the world today. Developed by Bussmann, they comply with the very latest requirements of IEC 60282-1, are lead and cadmium free (meeting the RoHS and WEE directives) and have been designed to meet current and future global electrical utility specifications.

The 'T' range offers time-current characteristics that are optimised to improve discrimination with upstream devices, giving fast clearance of earth faults in secondary terminal zones. The fuse links utilise Bussmann M-effect technology, ensuring low power consumption during operation, while at the same time providing temperature limitation in the event of an overload fault.

The fuse links are suitable for both indoor and outdoor applications and are fitted with a spring striker. This gives either an output force of 80N with a travel of 30 mm in the case of fuse links with part numbers sequence 'E', or in the case of part numbers referring to 'S', a spring striker with an output force of 50 N and a maximum travel of 26 mm.

Bussmann 'F' Range

The 'F' range fuse links have 'full range' clearing capability. Bussmann 'F' fuse links types are designed to clear low overloads right down to the fuse links' Current in accordance with the latest IEC 60282-1 requirements. They are thus suitable for use as a sole form of protection. 'F' range time-current characteristics are especially advantageous for transformer protection applications.

Bussmann 'A' Range

This earlier, well proven, design has values of minimum breaking current between the 'T' and 'F' range including higher current ratings.

Applications

MV DIN Fuse links are suitable for primary side transformer protection, fuse switch combination unit, fuse bases and fuse switches.

Features and benefits

Certification. Bussmann Medium Voltage (MV) DIN range of fuse links has been fully tested and certified. Interrupting performance has been certified at the world class independent test laboratories of KEMA. All other performance requirements such as temperature-rise, time-current characteristics, weather sealing etc. have been thoroughly tested to ASTA approval procedures.

All Bussmann medium voltage DIN Fuse links exhibit **cool running and low power dissipation** during normal operation in service. The use of **M-effect, drastically reduces the temperature of the fuse link during operation.** The larger cross section of the fuse link elements made possible by using M-effect ensures cooler running and low power dissipation under normal service conditions. **This ensures maximum levels of network efficiency by reducing unnecessary power loss** and minimizing switchgear wear and tear due to the fact the fuse link is running much cooler during its service life.

Cool operation. When Bussmann MV Fuse links operate under low fault conditions, the maximum temperature rise of the fuse link is well within the temperature limits for all switchgear due to the use of M-effect, ensuring fuse carrier contacts remain unimpaired, thereby **increasing the life cycle of the substation and so reducing capital and maintenance costs.**

Silver elements. All Bussmann back-up MV Fuse links use 99.8% pure silver in their elements, ensuring high conductivity and **low power (revenue) loss, maximising network efficiency.**

Reduced nuisance operation due to surge currents. The use of M-effect allows a larger element cross section for a given current rating, **improving withstand capability** against transient overcurrents due to transformer magnetizing inrush current, reducing maloperation. **This improves system reliability reducing maintenance costs.**

Low arc voltages during short-circuit operation. Bussmann MV Fuse links are designed to produce low levels of arc voltage, allowing fuse link **to be used down to half their Voltage**, so during short-circuit operation, the switchgear and cables are not unduly stressed by being exposed to high arc voltages, thereby **prolonging the life of the switchgear and improving asset utilisation.**

Additionally, **stock holdings and part numbers can be reduced**, as a 24 kV Bussmann MV DIN fuse link can be used on a 12 kV system. Utilities that run a mixed voltage network (say 24, 15.5, 13.8 12 and 10 kV) can **standardise on one type of switchgear** with one type of fuse link, **reducing costs and removing the need for an additional fuse extension and inventory.**

Construction. All electrical connections within the Bussmann MV Fuse link are made by welded or brazed joints. This firstly ensures a very mechanically robust fuse link and secondly, greatly reduces the risk of poor intermittent internal contacts, improving substation reliability.

X-Ray. All Bussmann MV Fuse links are X-rayed during production. Element alignment, M-effect position, etc are all checked by trained operators. This process ensures defects that would not normally be detected by purely visual or electrical based quality systems, to be captured during production.

Element design. Unlike many other medium voltage fuse link manufacturers, Bussmann medium voltage fuse elements employ a "neck" or 'notch' design principle as opposed to a perforated element design principle, see diagram below.



Bussmann - Neck or notch design



Other Medium voltage fuse links with perforated designs

This element design insures that even the smallest degree of accidental element damage is easily detected during testing, as part of the manufacturing process thus avoids the possibility of such imperfect fuses being put into service. This is far more difficult to achieve with perforated element designs.

Lead and cadmium Free. All Bussmann 'T' Ranges fuse links are lead and cadmium free and meet with the latest WEEE and RoHS directives. RoHS is less than 1000 VAC.

Recycling scheme. Bussmann operates a recycling scheme for all medium voltage fuse links, please contact buletechnical@eaton.com for further information.

General guide to the selection of DIN Back-up fuse links

Back-up fuse links

Selection guide using low voltage fuse links operating class gG/gL on low voltage side for individual cable exit protection see figure 1.

		Transformer primary voltage					
		10 kV		20 kV		30 kV	
Fuse links type	Transformer rating	Current of the medium voltage fuse link		Current of the medium voltage fuse link		Current of the medium voltage fuse link	
Back-up fuse links	(kVA)	Min	Max	Min	Max	Min	Max
	50	6.3	10	6.3	6.3	3.15	3.15
	100	16	25	6.3	10	6.3	10
	125	16	25	10	16	6.3	10
	160	20	31.5	10	20	6.3	10
	200	20	40	16	25	10	16
	250	25	50	16	25	10	16
	315	31.5	63	20z	31.5	16	16
	400	40	80	20	40	16	25
	500	50	100	25	50	16	31.5
	630	63	125	31.5	63	20	40
	800	80	125	40	63	25	40
	1000	100	125	50	80	31.5	50
	1250	125	200	63	80	40	50
	1600	160	200	71	125	50	63
	2000	200	200	100	160	63	63

Selection guide using low voltage fuse links operation class gG/gL on low voltage side for overload protection of the transformer, see figure 2.

		Transformer primary voltage						
		10 kV		20 kV		30 kV		
Fuse links type	Transformer rating	Current of the medium voltage fuse link		Current of the medium voltage fuse link		Current of the medium voltage fuse link		Low voltage NH Fuse size
Back-up fuse links	(kVA)	Min	Max	Min	Max	Min	Max	(A)
	50	10	10	6.3	6.3	3.15	3.15	63
	100	16	25	10	10	6.3	10	125
	125	20	25	10	16	6.3	10	160
	160	25	31.5	16	20	10	10	200
	200	31.5	40	16	25	16	16	250
	250	40	50	20	25	16	16	315
	315	50	63	25	31.5	16	20	400
	400	63	80	31.5	40	20	25	500
	500	80	100	40	50	25	31.5	630
	630	100	125	63	63	31.5	40	800
	800	125	160	63	63	40	40	1000
	1000	200	200	80	80	50	50	1250

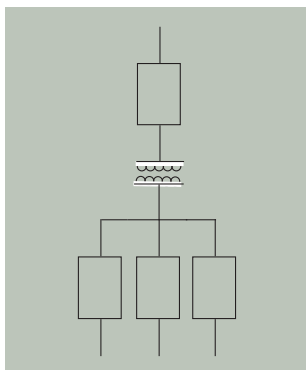

Figure 1 Individual cable exit protection

Figure 1: shows single exit from transformer. The cable exits the transformer and is fed directly to the distribution system. There is no secondary overload fuse protection. So the MV primary fuse must coordinate with the largest fuse within the distribution panel.

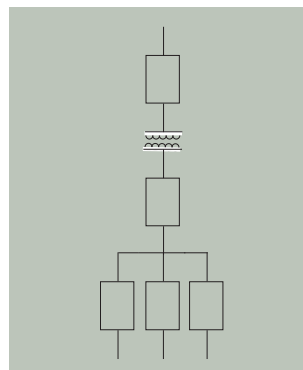

Figure 2 Overload protection of the transformer

Figure 2: Shows a fuse fitted as secondary overload protection directly on the transformer secondary output. The preferred method, the MV primary fuse must coordinate with the secondary overload LV fuse.

General guide to the selection of DIN Full range fuse links

Full range fuse links

Selection guide using low voltage fuse links operating class gG/gL on low voltage side for individual cable exit protection, see figure 1 opposite page.

Fuse links type	Transformer rating (kVA)	Transformer primary voltage			
		10 kV		20 kV	
		Current of the medium voltage fuse link		Current of the medium voltage fuse link	
Full range fuse links		Min	Max	Min	Max
	50	6.3	10	6.3	6.3
	100	10	20	6.3	10
	125	16	25	6.3	16
	160	16	31.5	10	16
	200	20	40	10	20
	250	25	50	16	25
	315	31.5	63	16	31.5
	400	40	80	20	40
	500	50	100	25	45
	630	63	100	31.5	45
	800	80	100	40	45
	1000	100	100	45	45

Selection guide using low voltage fuse links operating class gG/gL on low voltage side for overload protection of the transformer, see figure 2 opposite page

Fuse links Type	Transformer Rating (kVA)	Transformer primary voltage				Low voltage NH Fuse size gG/gL (A)
		10 kV		20 kV		
		Current of the medium voltage fuse link		Current of the medium voltage fuse link		
Full range Fuse links		Min	Max	Min	Max	
	50	6.3	6.3	6.3	6.3	80
	100	10	10	10	10	125
	125	16	16	10	10	160
	160	16	20	16	16	200
	200	20	31.5	16	16	250
	250	31.5	40	16	20	315
	315	40	40	20	20	400
	400	40	63	25	31.5	500
	500	50	63	31.5	40	630
	630	100	100	40	45	800
	800	100	100	-	-	1000

Selection of these MV Fuse links has been based on the followings:

1. The fuse link should withstand transformer magnetising inrush currents, taken as 12 times full load current for 0.1 seconds.
2. The primary MV Fuse link should discriminate with the secondary LV Fuse in all cases as shown in figure 2.
Where individual cable exit is used and no secondary LV Fuse is fitted, the MV Fuse should discriminate with the largest fuse fitted downstream to the secondary side of the transformer at the distribution panel.
3. The fuse link should operate within two seconds for transformers complying with IEC 60076-5 in respect of impedance, voltage and short-circuit withstand current.
4. The fuse link should operate reasonably quickly in the event of a transformer internal fault or an earth fault in the secondary terminal zone of the transformer.
5. In the case where there is no secondary fuse link for overload protection, the minimum recommended MV Fuse link rating applies to the use of fuse links in encapsulated enclosures where permissible continuous overload is generally limited to 120% of transformer full load current. However, if greater overload currents are permissible, a higher rating of fuse link may be required. Where the fuse link is used in open air or conditions of unrestricted ventilation a higher permissible overload may be possible.
6. In most cases more than one rating of MV Fuse link is recommended for a particular transformer size. Choice of fuse link will then depend on which fuse link offers the best protection; e.g., having one fuse link for several transformer sizes.

Recommendations for other voltage are available on request, please email buletechnical@eaton.com.

3.6 kV - 'A & W' Range current limiting back-up fuse links

Specifications

Description

A range of medium voltage DIN Fuse links, complete with striker, suitable for transformer protection. The fuse links can be used even when there is no secondary low voltage protection, provided they are used with fuse switches fitted with instantaneous striker tripping mechanism.

Ratings

Voltage: 3.6 kV

Current: 6.3 - 200 A

Breaking capacity: 40 - 50 kA.

Agency information

Comply with DIN Dimensional standard DIN 43625, VDE 0670 part 4 and with IEC 60282-1 (2005).

Suitable for indoor use.

Time-current curves and cut-off curves

See list page 117 and data on USB at the back of the catalogue.

Features and benefits

- Cool running, low watts loss and power dissipation thanks to the M-effect ensuring high levels of substation utilisation.
- Silver elements ensuring high conductivity and low power (revenue) loss.
- 100% X-ray, all our medium voltage fuse links are X-rayed ensuring the highest possible standards are maintained.

Typical applications

- Primary side transformer protection.
- Used in fuse switch combination unit.
- Used in fuse bases.
- Used in fuse switches.

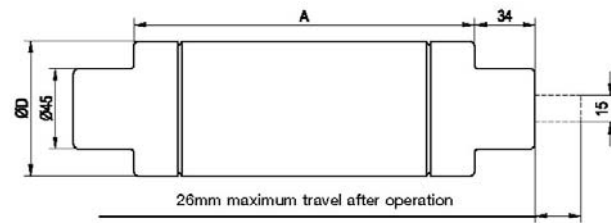

Dimensions - mm

Fuse reference	A	C	D	Weight (Kg)
ADLSJ	292	54	51	1.63
ADOSJ	192	54	51	1.1
WDOSJ	192	54	51	1.1
WFOSJ	192	76	76	2.1

Part numbers and technical data

Part numbers	Current I _n (A)	Breaking capacity I _b kA	Minimum breaking current I _g (A)	Cold resistance & watts loss in free air		Joule integral (I ² t)		Length mm	Diameter mm	Weight kg
				mΩ	W	Minimum pre-arcing	Maximum operating			
3.6ADLSJ6.3	6.3	40	13	158	9	4.5 x 10 ¹	1.9 x 10 ²	292	51	1.63
3.6ADLSJ10	10	40	13	95.6	13	1.3 x 10 ²	5.4 x 10 ²	292	51	1.63
3.6ADLSJ16	16	40	20	63.3	22	3 x 10 ²	1.3 x 10 ³	292	51	1.63
3.6ADLSJ20	20	40	31	45.9	25	6.3 x 10 ²	2.7 x 10 ³	292	51	1.63
3.6ADLSJ25	25	40	106	28.7	25	1.3 x 10 ²	1.2 x 10 ³	292	51	1.63
3.6ADLSJ31.5	31.5	40	106	19.1	26	2.9 x 10 ²	2.7 x 10 ³	292	51	1.63
3.6ADLSJ40	40	40	106	11.4	25	8 x 10 ²	7.5 x 10	292	51	1.63
3.6ADOSJ6.3	6.3	40	13	158	9	4.5 x 10 ¹	1.9 x 10 ²	192	51	1.1
3.6ADOSJ10	10	40	31	79.2	11	2.3 x 10 ²	9.7 x 10 ²	192	51	1.1
3.6ADOSJ16	16	40	49	50.8	18	5.5 x 10 ²	2.4 x 10 ³	192	51	1.1
3.6ADOSJ20	20	40	49	38.1	21	9.8 x 10 ²	4.2 x 10 ³	192	51	1.1
3.6ADOSJ25	25	40	106	28.9	25	1.3 x 10 ²	1.2 x 10 ³	192	51	1.1
3.6ADOSJ31.5	31.5	40	106	19.2	26	2.9 x 10 ²	2.7 x 10 ³	192	51	1.1
3.6ADOSJ40	40	40	106	11.6	26	8 x 10 ²	7.5 x 10 ³	192	51	1.1
3.6WDOSJ50	50	50	180	5.36	20	1.8 x 10 ³	2.4 x 10 ⁴	192	51	1.1
3.6WDOSJ63	63	50	225	3.68	21	3.8 x 10 ³	4.5 x 10 ⁴	192	51	1.1
3.6WDOSJ80	80	50	288	2.88	27	6.3 x 10 ³	8 x 10 ⁴	192	51	1.1
3.6WDOSJ100	100	50	360	2.16	31	9.8 x 10 ³	1.1 x 10 ⁵	192	51	1.1
3.6WDOSJ125	125	50	450	1.73	39	1.5 x 10 ⁴	2.2 x 10 ⁵	192	51	1.1
3.6WFOSJ160	160	50	600	1.28	47	3.1 x 10 ⁴	6.2 x 10 ⁵	192	76	2.1
3.6WFOSJ200	200	50	600	0.94	52	5.7 x 10 ⁴	1.1 x 10 ⁶	192	76	2.1

7.2 kV - 'T' Range current limiting back-up fuse links

Specifications

Description

A range of medium voltage DIN Fuse links complete with striker, suitable for transformer protection. The fuses can be used even when there is no secondary low voltage protection, provided they are used with fuse switches fitted with instantaneous striker tripping.

Ratings

Voltage: 3 - 7.2 kV

Current: 6.3 - 160 A

Breaking capacity: 40 kA

Agency information

Comply with DIN Dimensional standard DIN 43625, VDE 0670 part 4 and with IEC 60282-1 (2005). Suitable for indoor and outdoor use.

Time-current curves and cut-off curves

See list page 117 and data on USB at the back of the catalogue.

Features and benefits

- Cool running, low watts loss and power dissipation thanks to the M-effect ensuring high levels of substation utilisation.
- Silver elements ensuring high conductivity and low power (revenue) loss.
- 100% X-ray, all our medium voltage fuse links are X-rayed ensuring the highest possible standards are maintained.

Typical applications

- Primary side transformer protection.
- Used in fuse switch combination unit.
- Used in fuse bases.
- Used in fuse switches.

Part numbers and technical data

Part numbers	Current I_n (A)	Breaking capacity I_1 (kA)	Minimum breaking current I_3 (A)	Cold resistance & watts loss in free air		Joule integral (I ² t)		Length mm	Diameter mm	Weight kg
				mΩ	W	Minimum pre-arcing	Maximum operating			
7.2TDLSJ6.3	6.3	40	20	205	11	4.8×10^1	6.5×10^3	292	51	1.63
7.2TDLSJ10	10	40	31	99.7	19	2.5×10^2	2.7×10^3	292	51	1.63
7.2TDLSJ16	16	40	49	65.1	23	5.5×10^2	8.2×10^3	292	51	1.63
7.2TDLSJ20	20	40	49	48.9	27	9.7×10^2	1.1×10^4	292	51	1.63
7.2TDLSJ25	25	40	80	32.6	28	5.7×10^2	8×10^3	292	51	1.63
7.2TDLSJ31.5	31.5	40	100	26	36	8.9×10^2	1×10^4	292	51	1.63
7.2TDLSJ40	40	40	114	16	36	2×10^3	2.2×10^4	292	51	1.63
7.2TDLSJ50	50	40	143	12.9	46	3.2×10^3	3.2×10^4	292	51	1.63
7.2TDLSJ63	63	40	180	8.14	45	8×10^3	7.5×10^4	292	51	1.63
7.2TFLSJ80	80	40	264	61	54	5×10^3	6.5×10^4	292	76	3.1
7.2TFLSJ100	100	40	338	4.65	64	9.1×10^3	1.1×10^5	292	76	3.1
7.2TFLSJ125	125	40	375	3.60	79	1.5×10^4	1.7×10^5	292	76	3.1
7.2TFLSJ160	160	40	525	2.73	97	3×10^4	3.1×10^5	292	76	3.1

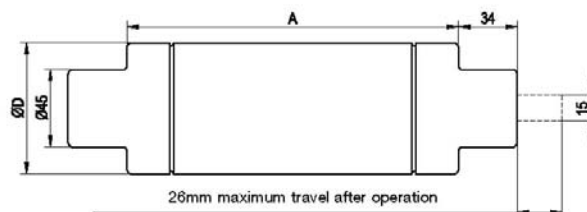

Dimensions - mm

Fuse reference	A	C	D	Weight (Kg)
TDLSJ	292	54	51	1.63
TFLSJ	292	80	76	3.1

12 kV - 'F' Range current limiting full range fuse links

Specifications

Description

A range of medium voltage DIN Fuse links, complete with sealed striker, suitable for transformer protection. Bussmann 'F' range provide full range protection.

Ratings

Voltage: 12 kV

Current: 6.3 - 100 A.

Breaking capacity: 50 kA.

Agency information

Comply with DIN Dimensional standard DIN 43625, VDE 0670 part 4, VDE 0670 part 402 and with IEC 60282-1 (2005). Suitable for indoor use.

Time-current curves and cut-off curves

See list page 117 and data on USB at the back of the catalogue.

Features and benefits

- Cool running, low watts loss and power dissipation thanks to the M-effect ensuring high levels of substation utilisation.
- Silver elements ensuring high conductivity and low power (revenue) loss.
- 100% X-ray, all our medium voltage fuse links are X-rayed ensuring the highest possible standards are maintained.
- Our full range MV Fuse links can interrupt any current below the rated breaking capacity.

Typical applications

- Primary side transformer protection.
- Used in fuse switch combination unit.
- Used in fuse bases without instantaneous striker tripping.
- Used in fuse switches.

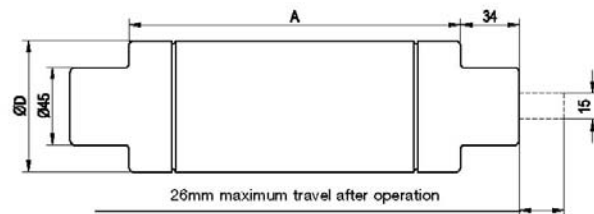

Dimensions - mm

Fuse reference	A	C	D	Weight (Kg)
FDLSJ	292	54	51	1.63
FFLSJ	292	80	76	3.16
FXLSJ	292	92	88	4

Part numbers and technical data

Part numbers	Current I_n (A)	Breaking capacity I_1 (kA)	Minimum breaking current I_3 (A)	Cold resistance & watts loss in free air		Joule integral (I ² t)		Length mm	Diameter mm	Weight kg
				mΩ	W	Minimum pre-arcing	Maximum operating			
12FDLSJ6.3	6.3	50	6.3	208	10	6.9×10^1	6.3×10^2	292	51	1.63
12FDLSJ10	10	50	10	116	15	2.2×10^2	2.1×10^3	292	51	1.63
12FDLSJ16	16	50	16	55.4	17	8.8×10^2	3.9×10^3	292	51	1.63
12FDLSJ20	20	50	20	39.6	20	1.7×10^3	7.6×10^3	292	51	1.63
12FDLSJ25	25	50	25	31.2	26	2.8×10^3	1.3×10^4	292	51	1.63
12FDLSJ31.5	31.5	50	31.5	26.4	36	2.6×10^3	1.3×10^4	292	51	1.63
12FFLSJ40	40	50	40	19.7	42	3.8×10^3	3.8×10^4	292	76.2	3.16
12FFLSJ50	50	50	50	14.8	51	6.8×10^3	5.6×10^4	292	76.2	3.16
12FFLSJ63	63	50	63	12.4	72	5.1×10^3	5.4×10^4	292	76.2	3.16
12FXLSJ80	80	50	80	7.94	72	2.2×10^4	1.1×10^5	292	88	4
12FXLSJ100	100	50	100	5.64	82	4.2×10^4	2×10^5	292	88	4

12 kV - 'A' and 'T' Range current limiting back-up range fuse links

Specifications

Description

A range of medium voltage DIN Fuse links, complete with sealed striker, suitable for transformer protection. The fuse links can be used even when there is no secondary low voltage protection, provided they are used with fuse switches fitted with instantaneous striker tripping.

Ratings

Voltage: 6 - 12 kV

Current: 6.3 - 200 A

Breaking capacity: 50 - 63 kA

Agency information

Comply with DIN Dimensional standard DIN 43625, VDE 0670 part 4, VDE 0670 part 402 and with IEC 60282-1 (2005). Suitable for indoor and outdoor use.

Time-current curves and cut-off curves

See list page 117 and data on USB at the back of the catalogue.

Features and benefits

- Cool running, low watts loss and power dissipation, thanks to the M-effect ensuring high levels of substation utilisation.
- Silver elements ensuring high conductivity and low power (revenue) loss.
- 100% X-ray, all our high voltage fuse links are X-rayed ensuring the highest possible standards are maintained.

Typical applications

- Primary side transformer protection
- Used in fuse switch combination unit
- Used in fuse bases
- Used in fuse switches.

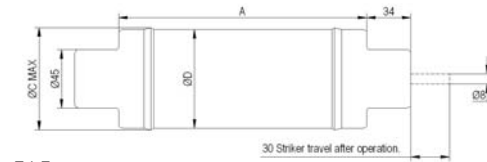

EJ Fuses

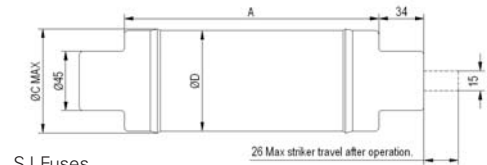

SJ Fuses

Dimensions - mm

Fuse reference	A	C	D	Weight (Kg)
AILSJ	292	79	76	3.3
TDLEJ	292	54	51	1.7
THLEJ	292	67	64	2.6
TKLEJ	292	80	76	3.5
TXLEJ	292	88	88	3.7
THMEJ	442	67	64	3.7
TFMSJ	442	80	76	5.1

Part numbers and technical data

Part numbers	Current I _n (A)	Breaking capacity I ₁ (kA)	Minimum breaking current I ₃ (A)	Cold resistance & watts loss in free air		Joule integral (I ² t)		Length mm	Diameter mm	Weight kg
				mΩ	W	Minimum pre-arcing	Maximum operating			
12TDLEJ6.3	6.3	63	23	222	10	9.8 x 10 ¹	1 x 10 ³	292	51	1.7
12TDLEJ10	10	63	35	131	16	2.8 x 10 ²	2.3 x 10 ³	292	51	1.7
12TDLEJ16	16	63	53	54.6	16	2.6 x 10 ²	3.9 x 10 ³	292	51	1.7
12TDLEJ20	20	63	73	39.1	18	5.2 x 10 ²	5.4 x 10 ³	292	51	1.7
12TDLEJ25	25	63	87	31.2	24	8.1 x 10 ²	8.4 x 10 ³	292	51	1.7
12TDLEJ31.5	31.5	63	111	23.4	28	1.4 x 10 ³	1.5 x 10 ⁴	292	51	1.7
12TDLEJ40	40	63	143	17.2	36	2.4 x 10 ³	2.5 x 10 ⁴	292	51	1.7
12TDLEJ50	50	63	168	13.5	47	2.8 x 10 ³	3.1 x 10 ⁴	292	51	1.7
12TDLEJ63	63	63	235	10.6	60	4.3 x 10 ³	4.7 x 10 ⁴	292	51	1.7
12THLEJ80	80	63	272	7.81	72	7.9 x 10 ³	9.1 x 10 ⁴	292	64	2.6
12THLEJ100	100	63	388	5.74	85	2 x 10 ⁴	1.4 x 10 ⁵	292	64	2.6
12AILSJ100*	100	31.5	176	53	70	1.4 x 10 ⁴	2 x 10 ⁵	292	76	3.3
12TKLEJ125	125	63	687	3.99	93	4 x 10 ⁴	3.5 x 10 ⁵	292	76	3.5
12TXLEJ160**	160	63	560	4.3	217	1.1 x 10 ⁵	5 x 10 ⁵	292	88	3.7
12TXLEJ200**	200	63	610	3.8	333	1.5 x 10 ⁵	6.5 x 10 ⁵	292	88	3.7
12THMEJ100	100	63	272	5.74	85	2 x 10 ⁴	1.4 x 10 ⁵	442	64	3.7
12TFMSJ160	160	50	485	3.65	139	5 x 10 ⁴	3.5 x 10 ⁵	442	76	5.1

* Not suitable for outdoor use / ** Not compliant with VDE 0670 part 402

17.5 kV - 'A' and 'T' Range current limiting back-up range fuse links

Specifications

Description

A range of medium voltage DIN Fuse links, complete with sealed striker, suitable for transformer protection. The fuse links can be used even when there is no secondary low voltage protection, provided they are used with fuse switches fitted with instantaneous striker tripping.

Ratings

Voltage: 10 - 17.5 kV
 Current: 6.3 - 125 A
 Breaking capacity: 20 - 50 kA

Agency information

Comply with DIN Dimensional standard DIN 43625, VDE 0670 part 4, VDE 0670 part 402 and with IEC 60282-1 (2005).

'A' range is suitable for indoor use.

'T' range is suitable for indoor and outdoor use .

Time-current curves and cut-off curves

See list page 117 and data on USB at the back of the catalogue.

Features and benefits

- Cool running, low watts loss and power dissipation thanks to the M-effect ensuring high levels of substation utilisation.
- Silver elements ensuring high conductivity and low power (revenue) loss.
- 100% X-ray, all our high voltage fuse links are X-rayed ensuring the highest possible standards are maintained.

Typical applications

- Primary side transformer protection
- Used in fuse switch combination unit
- Used in fuse bases
- Used in fuse switches.

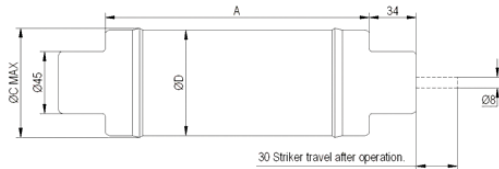

EJ Fuses

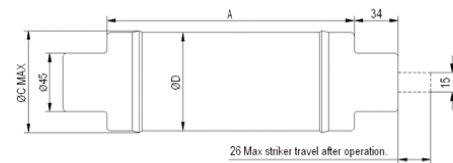

SJ Fuses

Dimensions - mm

Fuse reference	A	C	D	Weight (Kg)
AILSJ	442	79	76	4.5
TDLSJ	292	54	51	1.7
TFLSJ	292	80	76	3.1
TDMEJ	442	54	51	2.5
THMEJ	442	67	64	3.7
TKMEJ	442	80	76	5.1

Part numbers and technical data

Part numbers	Current I_n (A)	Breaking capacity I_1 (kA)	Minimum breaking current I_3 (A)	Cold resistance & watts loss in free air		Joule integral (I^2t)		Length mm	Diameter mm	Weight kg
				mΩ	W	Minimum pre-arcing	Maximum operating			
17.5AILSJ40*	100	25	176	7.33	102	1.4×10^4	2×10^5	442	76	4.5
17.5AILSJ50*	50	20	137	29.5	102	1.8×10^3	2.9×10^4	442	76	4.5
17.5AILSJ63*	63	20	125	23.6	130	3.2×10^3	4.5×10^4	442	76	4.5
17.5TDLSJ6.3*	6.3	35.5	23	313	15	4.8×10^1	6.1×10^2	292	51	1.7
17.5TDLSJ10*	10	35.5	19	185	23	2.8×10^2	4×10^3	292	51	1.7
17.5TDLSJ16*	16	35.5	59	104	34	2.9×10^2	2×10^3	292	51	1.7
17.5TDLSJ20*	20	35.5	80	69.2	38	5.7×10^2	4.4×10^3	292	51	1.7
17.5TDLSJ25*	25	35.5	100	55.4	48	8.9×10^2	6.6×10^3	292	51	1.7
17.5TDLSJ31.5*	31.5	35.5	118	41.4	58	5.1×10^2	1.1×10^4	292	51	1.7
17.5TDLSJ40*	40	35.5	148	31.1	76	8×10^2	1.8×10^4	292	51	1.7
17.5FLSJ50*	50	35.5	225	17.3	62	8.1×10^3	6×10^4	292	76	3.1
17.5TDMEJ6.3	6.3	50	25	324	14	9.8×10^1	1×10^3	442	51	2.5
17.5TDMEJ10	10	50	36	192	24	2.8×10^2	2.3×10^3	442	51	2.5
17.5TDMEJ16	16	50	55	79.6	23	2.6×10^2	3.9×10^3	442	51	2.5
17.5TDMEJ20	20	50	69	57	27	5.2×10^2	5.4×10^3	442	51	2.5
17.5TDMEJ25	25	50	87	45.5	34	8.1×10^2	8.4×10^3	442	51	2.5
17.5TDMEJ31.5	31.5	50	87	34.1	41	1.4×10^3	1.5×10^4	442	51	2.5
17.5TDMEJ40	40	50	111	25	53	2.4×10^3	2.5×10^4	442	51	2.5
17.5TDMEJ50	50	50	174	19.7	69	2.8×10^3	3.1×10^4	442	51	2.5
17.5TDMEJ63	63	50	200	15.4	89	4.3×10^3	4.7×10^4	442	51	2.5
17.5THMEJ80	80	50	270	11.5	108	7.9×10^3	9.1×10^4	442	64	3.7
17.5THMEJ100	100	50	376	8.38	127	2×10^4	1.4×10^5	442	64	3.7
17.5TKMEJ125	125	50	467	5.95	146	3.4×10^4	3.5×10^5	442	76	5.1

* Not suitable for outdoor use

24 kV - 'F' Range current limiting full range fuse links

Specifications

Description

A range of medium voltage DIN Fuse links, complete with sealed striker, suitable for transformer protection. Bussmann 'F' range provide Full range protection.

Ratings

Voltage: 24 kV

Current: 6.3 - 45 A

Breaking capacity: 35.5 kA

Agency information

Comply with DIN Dimensional standard DIN 43625, VDE 0670 part 4, VDE 0670 part 402 and with IEC 60282-1 (2005). Suitable for indoor use.

Time-current curves and cut-off curves

See list page 117 and data on USB at the back of the catalogue.

Features and benefits

- Cool running, low watts loss and power dissipation thanks to the M-effect ensuring high levels of substation utilisation.
- Silver elements ensuring high conductivity and low power (revenue) loss.
- 100% X-ray, all our high voltage fuse links are X-rayed ensuring the highest possible standards are maintained.
- Our full range of MV Fuse links can interrupt any current below the rated breaking capacity.

Typical applications

- Primary side transformer protection.
- Used in fuse switch combination unit.
- Used in fuse bases without instantaneous striker tripping.
- Used in fuse switches.

Part numbers and technical data

Part numbers	Current I_n (A)	Breaking capacity I_1 (kA)	Minimum breaking current I_3 (A)	Cold resistance & watts loss in free air		Joule integral (I ² t)		Length mm	Diameter mm	Weight kg
				mΩ	W	Minimum pre-arcing	Maximum operating			
24FDMSJ6.3	6.3	35.5	6.3	437	21	6.8×10^1	5.4×10^2	442	51	2.2
24FDMSJ10	10	35.5	10	218	29	2.7×10^2	2.1×10^3	442	51	2.2
24FDMSJ16	16	35.5	16	118	39	8.2×10^2	2.7×10^3	442	51	2.2
24FDMSJ20	20	35.5	20	82.2	43	1.6×10^3	5.1×10^3	442	51	2.2
24FDMSJ25	25	35.5	25	54.7	48	3.4×10^3	1.2×10^4	442	51	2.2
24FDMSJ31.5	31.5	35.5	31.5	48.6	71	3.2×10^3	1.2×10^4	442	51	2.2
24FFMSJ25	25	35.5	25	58.6	47	3.4×10^3	1.1×10^4	442	76.2	4.5
24FFMSJ31.5	31.5	35.5	31.5	48.8	70	4.7×10^3	1.5×10^4	442	76.2	4.5
24FFMSJ40	40	35.5	40	38.4	85	7.6×10^3	2.5×10^4	442	76.2	4.5
24FFMSJ45	45	35.5	45	31.4	92	7.2×10^3	3×10^4	442	76.2	4.5

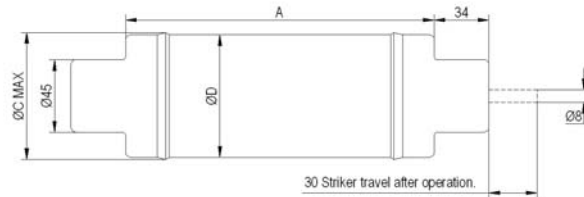

Dimensions - mm

Fuse reference	A	C	D	Weight (Kg)
FDMSJ	442	54	51	2.2
FFMSJ	442	67	76	4.5

24 kV - 'A' and 'T' Range current limiting back-up fuse links

Specifications

Description

A range of medium voltage DIN Fuse links, complete with sealed striker, suitable for transformer protection. The fuse links can be used even when there is no secondary low voltage protection, provided they are used with fuse switches fitted with instantaneous striker tripping.



Ratings

Voltage: 12 - 24 kV

Current: 6.3 - 160 A

Breaking capacity: 20 - 63 kA

Agency information

Comply with DIN Dimensional standard DIN 43625, VDE 0670 part 4, VDE 0670 part 402 and with IEC 60282-1 (2005).

'A' range is suitable for indoor use.

'T' range is suitable for indoor and outdoor use.

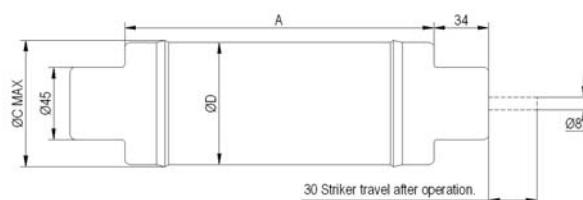

Time-current curves and cut-off curves

See list page 117 and data on USB at the back of the catalogue.

Features and benefits

- Cool running, low watts loss and power dissipation thanks to the M-effect ensuring high levels of substation utilisation.
- Silver elements ensuring high conductivity and low power (revenue) loss.
- 100% X-ray, all our medium voltage fuse links are X-rayed ensuring the highest possible standards are maintained.

Dimensions - mm

Fuse reference	A	C	D	Weight (Kg)
AFMSJ	442	79	76	4.5
AIMSJ	442	79	76	4.5
TDMEJ	442	54	51	2.5
THMEJ	442	67	64	3.7
TFMEJ	442	80	76	5.1
TXMEJ	442	91	88	5.9

Typical applications

- Primary side transformer protection.
- Used in fuse switch combination unit.
- Used in fuse bases.
- Used in fuse switches.

Part numbers and technical data

Part numbers	Current I _n (A)	Breaking capacity I ₁ (kA)	Minimum breaking current I ₃ (A)	Cold resistance & watts loss in free air		Joule integral (I ² t)		Length mm	Diameter mm	Weight kg
				mΩ	W	Minimum pre-arcing	Maximum operating			
24AFMSJ50	50	20	137	29.5	102	1.8 x 10 ³	2.9 x 10 ⁴	442	76	4.5
24AFMSJ63	63	20	125	23.6	130	3.2 x 10 ³	4.5 x 10 ⁴	442	76	4.5
24AIMSJ71	71	20	176	15.1	106	6.3 x 10 ³	8.5 x 10 ⁴	442	76	4.5
24TDMEJ6.3	6.3	50	23	444	20	9.8 x 10 ¹	1 x 10 ³	442	51	2.5
24TDMEJ10	10	50	34	262	32	2.8 x 10 ²	2.3 x 10 ³	442	51	2.5
24TDMEJ16	16	50	56	109	34	2.6 x 10 ²	3.9 x 10 ³	442	51	2.5
24TDMEJ20	20	50	73	78.2	38	5.2 x 10 ²	5.4 x 10 ³	442	51	2.5
24TDMEJ25	25	50	92	62.4	49	8.1 x 10 ²	8.4 x 10 ³	442	51	2.5
24TDMEJ31.5	31.5	50	92	46.8	59	1.4 x 10 ³	1.5 x 10 ⁴	442	51	2.5
24TDMEJ40	40	50	118	34.3	79	2.4 x 10 ³	2.5 x 10 ⁴	442	51	2.5
24TDMEJ50	50	50	185	27	98	2.8 x 10 ³	3.1 x 10 ⁴	442	51	2.5
24THMEJ63	63	50	217	21.1	127	4.3 x 10 ³	4.7 x 10 ⁴	442	64	3.7
24TFMEJ80	80	50	265	15.7	153	7.9 x 10 ³	9.1 x 10 ⁴	442	76	5.1
24TFMEJ100*	100	63	430	18	400	2.8 x 10 ⁴	9.4 x 10 ⁴	442	76	5.1
24TXMEJ125*	125	40	760	11	340	9.7 x 10 ⁴	3.5 x 10 ⁵	442	88	5.9
24TXMEJ160*	160	31.5	900	9.60	515	1.3 x 10 ⁵	5 x 10 ⁵	442	88	5.9

* Not compliant with VDE 0670 part 402

36 kV - 'T' Range current limiting back-up fuse links

Specifications

Description

A range of medium voltage DIN Fuse links, complete with sealed striker, suitable for transformer protection. The fuse links can be used even when there is no secondary low voltage protection, provided they are used with fuse switches fitted with instantaneous striker tripping.

Ratings

Voltage: 18 - 36 kV

Current: 3.15 - 63 A

Breaking capacity: 20 - 35.5 kA

Agency information

Comply with DIN Dimensional standard DIN 43625, VDE 0670 part 4, VDE 0670 part 402 and with IEC 60282-1 (2005). Suitable for indoor and outdoor use.

Time-current curves and cut-off curves

See list page 117 and data on USB at the back of the catalogue.

Features and benefits

- Cool running, low watts loss and power dissipation thanks to the M-effect ensuring high levels of substation utilisation.
- Silver elements ensuring high conductivity and low power (revenue) loss.
- 100% X-ray, all our medium voltage fuse links are X-rayed ensuring the highest possible standards are maintained.

Typical applications

- Primary side transformer protection.
- Used in fuse switch combination unit.
- Used in fuse bases.
- Used in fuse switches.

Part numbers and technical data

Part numbers	Current I _n (A)	Breaking capacity I ₁ (kA)	Minimum breaking current I ₃ (A)	Cold resistance & watts loss in free air		Joule integral (I ² t)		Length mm	Diameter mm	Weight kg
				mΩ	W	Minimum pre-arcing	Maximum operating			
36TDQSJ3.15	3.15	20	23	1455	18	2 x 10 ¹	2.4 x 10 ²	537	51	2.9
36TDQSJ6.3	6.3	35.5	23	684	34	1 x 10 ²	1.2 x 10 ³	537	51	2.9
36TDQSJ10	10	35.5	35	402	44	3.1 x 10 ²	3.6 x 10 ³	537	51	2.9
36TDQSJ16	16	35.5	70	165	52	4.6 x 10 ²	5.1 x 10 ³	537	51	2.9
36TDQSJ20	20	35.5	98	117	62	8.9 x 10 ²	8.2 x 10 ⁴	537	51	2.9
36TDQSJ25	25	35.5	112	98	85	1.2 x 10 ³	1.5 x 10 ⁴	537	51	2.9
36TFQSJ31.5	31.5	35.5	116	73.4	96	2.1 x 10 ³	2.3 x 10 ⁴	537	51	6
36TFQSJ40	40	35.5	178	52.4	116	4.1 x 10 ³	3.9 x 10 ⁴	537	76	6
36TFQSJ50	50	35.5	255	36.8	133	8.3 x 10 ³	8.1 x 10 ⁴	537	76	6
36TXQEJ63*	63	20	360	35	271	1.1 x 10 ⁴	6.2 x 10 ⁴	537	88	6.5

* Not compliant with VDE 0670 part 402

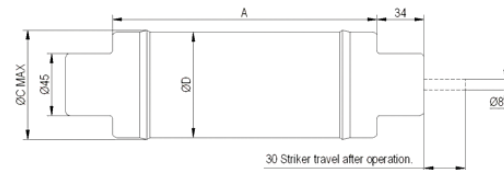

EJ Fuses

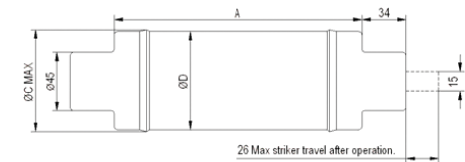

SJ Fuses

Dimensions - mm

Fuse reference	A	C	D	Weight (Kg)
TDQSJ	537	54	51	2.9
TFQSJ	537	80	76	6
TXQEJ	537	88	88	6.5

Striker force diagrams

E = Spring striker 80N to DIN IEC 60282-1 Designation 'Medium'

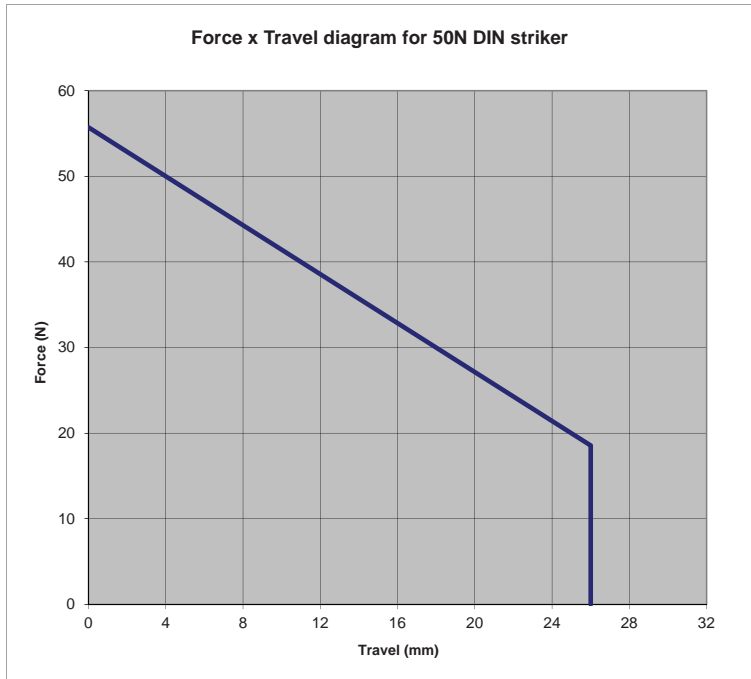

S = Spring striker 50N to DIN 43625 and IEC 60282-1 Designation 'Medium'

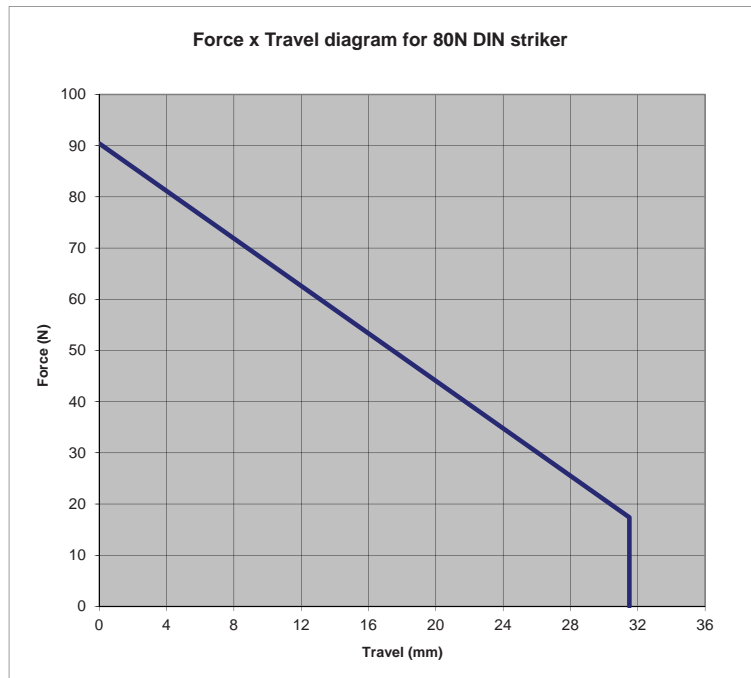

Medium voltage motor fuse links



Introduction to motor fuse links	25
British standard	
3.6 kV	26
7.2 kV	28
12 kV	29
DIN	
3.6 kV	30
7.2 kV	31
USA	
2.75 kV	32
5.5 kV	33

Introduction to medium voltage motor fuse links

- Motor fuse Links comply with IEC 60282-1, IEC 644 and BS 5907.
- Available in DIN 43625 and BS 2692 dimensions.
- Sold in a wide range of ratings from:
 - 3.6 kV - 5 to 450 A
 - 7.2 kV - 5 to 355 A
- North American dimensioned products also available, 2R to 24R ratings.

Bussmann motor fuse links

Bussmann range of motor fuse links are designed to meet the specific requirements necessary for motor protection. During the starting cycle of direct on-line motors, the fuse elements will reach a considerably higher temperature than during normal operation; this is due to the high amount of current the motor will draw as it starts, typically, 6 times its normal load current value. This results in expansion and contraction of the fuse elements and could cause premature operation of the fuse link. Bussmann motor fuse links encompass an advanced design to minimise this effect. This therefore, negates the need to over specify the fuse rating due to high values of motor starting current.

Bussmann fuse links operate extremely quickly under heavy fault currents, resulting from the time-current characteristic. Low power dissipation ensures low temperature rise, important in multi-tier starters for example. Switching (Arc) voltages are lower than permitted values, therefore, 5.5 kV fuse links are also suitable for 4.8 kV and 2.4 kV circuits.

Application

Fuse links provide short-circuit protection in motor circuits to both the motor starter and cables from the starter to the motor. Overload protection is provided by the motor starter, generally by an overload relay and contactor. Combination striker tripping may also form part of the associated equipment which houses the fuse links and motor starters.

Application procedure

For any motor the fuse current rating is determined by magnitude and duration of starting current, except in a few situations where the starting currents are very light.

Direct-on-line starting

In the absence of specific information, the starting current can usually be taken to be six times the motor's full load current. The starting time will depend on the type of the drive but will be approximately as follows:

- Pump motors - 6 seconds
- Mill motors - 10 to 15 seconds
- Fan motors - 60 seconds



These are average values and the appropriate figures for starting current and starting time for actual installation should be obtained wherever possible.

Multiply the starting current by 1.7 and using this value of current and the starting time, (it is recommended that a minimum time of five seconds be adopted), plot this point on the time-current characteristics of the fuse link. The correct current rating of the fuse link is then chosen as being the one immediately to the right of the point plotted. The chosen fuse link must also have a current rating of at least 1.3 times the full load current of the associated motor.

The rating chosen will be adequate for normal applications where the associated motor is not started more than twice in a given period of one hour.

For applications using more frequent starting duties, a greater derating factor must be applied as shown below:

- Maximum 2 starts per hour - Derating factor 1.7
- Maximum 4 starts per hour - Derating factor 1.9
- Maximum 8 starts per hour - Derating factor 2.1
- Maximum 16 starts per hour - Derating factor 2.4

Assisted starting

A similar method of fuse selection may be used as for direct-on-line starting (see above), but it must be noted that the normal running current of the motor is likely to be closer in value to the nominal current rating of the fuse link than for direct-on-line applications.

The rating of fuse link chosen will need to be appreciably greater than the motor running current to allow for restricted cooling inside control gear cubicles, particularly where multi-tier starters are involved. For further guidance please contact Bussmann: buletechnical@eaton.com.

Notes

For applications involving more frequent starting duties than 16 times per hour or where unusual duty cycles are involved, consult Bussmann application engineers for advice:

buletechnical@eaton.com or 00 44 (0) 1509 882 699.

3.6 kV - Motor fuse links to British standard dimensions

Specifications

Description

Motor fuse links providing short circuit protection in motor circuits to both the motor starter and cables from the starter to the motor.

Ratings

Voltage: 3.6 kV

Current: 5 - 450 A

Breaking capacity: 50 kA

Agency information

BS 2692-1

Time-current curves and cut-off curves

See list page 117 and data on USB at the back of the catalogue.



Features and benefits

- Cool running, low watts loss and power dissipation thanks to the M-effect.
- Silver elements ensuring high conductivity and low power (revenue) loss
- 100% X-ray, all our medium voltage fuse links are X-rayed ensuring the highest possible standards are maintained
- Allows motor start current to pass on without degradation of fuse link

Typical applications

- Motor protection

Dimensions - mm

Tag type '6' - BS 2692 Standard									
Fuse link Type	A	B	C	D	E	F	G	H	J
+WJON6	257	235	192	36	9.5	13	25	23	2.4
WDO*H6	261	235	192	51	10.5	13	25	29	2.6
WFO*H6	261	235	192	76	10.5	20	64	42	2.6

Tag type '0' - BS 2692 Standard				
Fuse link Type	A	B	C	D
WDFHO	337	305	254	51
WFFHO	337	305	254	76
WKFHO	337	305	254	76
WFGHO	442	410	359	76
WKGHO	442	410	359	76

Tag type '6'

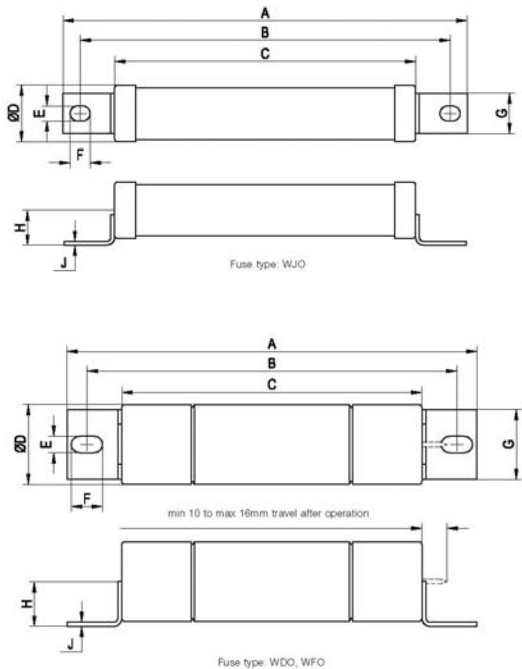

Tag type '0'

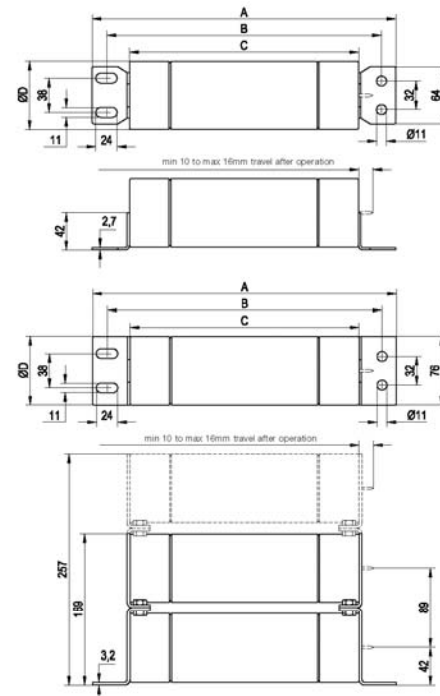

Triple barrel fuse link (3rd barrel shown dotted) with 03 tags.
Double barrel fuse link with 02 tags shown in full line.

Part numbers and technical data

Part numbers	Current I_n (A)	Breaking capacity I_b (kA)	Minimum breaking current I_3 (A)	Cold resistance & watts loss in free air		Joule integral (I ² t)		Length mm	Diameter mm	Weight kg
				mΩ	W	Minimum pre-arcing	Maximum operating			
Tag type '6' - BS 2692 Standard										
3.6WJON65	5	50	13	148	5	2×10^1	1.6×10^3	192	35	0.54
3.6WJON66.3	6.3	50	24	56.3	8	1.6×10^2	1.3×10^3	192	35	0.54
3.6WJON610	10	50	24	56.3	8	1.6×10^2	1.3×10^3	192	35	0.54
3.6WJON616	16	50	56	33.1	12	1.7×10^2	1.4×10^3	192	35	0.54
3.6WJON620	20	50	56	22.1	12	3.9×10^2	3.2×10^3	192	35	0.54
3.6WJON625	25	50	70	17.7	15	6.1×10^2	4.9×10^3	192	35	0.54
3.6WJON631.5	31.5	50	112	10.1	14	1.2×10^3	9.8×10^3	192	35	0.54
3.6WJON640	40	50	112	7.54	17	2.1×10^3	1.7×10^4	192	35	0.54
3.6WJON650	50	50	140	63	21	3.2×10^3	2.6×10^4	192	35	0.54
3.6WDOH650	50	50	180	5.36	20	1.8×10^3	2.4×10^4	192	51	1.1
3.6WDOH663	63	50	225	3.68	21	3.8×10^3	4.5×10^4	192	51	1.1
3.6WDOH680	80	50	288	2.88	27	6.3×10^3	8×10^4	192	51	1.1
3.6WDOH6100	100	50	360	2.16	31	9.8×10^3	1.1×10^5	192	51	1.1
3.6WDOH6125	125	50	450	1.73	39	1.5×10^4	2.2×10^5	192	51	1.1
3.6WFOH6160	160	50	600	1.28	47	3.1×10^4	6.2×10^5	192	76	2.1
3.6WFOH6200	200	50	600	0.94	52	5.7×10^4	1.1×10^6	192	76	2.1
Tag type 'O' - BS 2692 Standard										
3.6WDFH050	50	50	152	6.61	21	1.8×10^3	2.4×10^4	254	51	1.46
3.6WDFH063	63	50	171	53	28	3.1×10^3	4.5×10^4	254	51	1.46
3.6WDFH080	80	50	190	3.52	31	6.3×10^3	8×10^4	254	51	1.46
3.6WDFH0100	100	50	190	2.87	39	9.5×10^3	1.2×10^5	254	51	1.46
3.6WDFH0125	125	50	190	2.44	53	1.3×10^4	1.8×10^5	254	51	1.46
3.6WFFH0160	160	50	300	1.53	54	3.4×10^4	4.1×10^5	254	76	3.2
3.6WFFH0200	200	50	300	1.24	67	5.1×10^4	7.2×10^5	254	76	3.2
3.6WKFH0250	250	50	520	0.65	57	1.8×10^5	2.4×10^6	254	76	3.2
3.6WKFH0315	315	50	650	0.44	60	4.1×10^5	5×10^6	254	76	3.2
3.6WKFH0355	355	50	820	0.35	59	6.4×10^5	7×10^6	254	76	3.2
3.6WKFH0400	400	50	820	0.35	76	6.4×10^5	7×10^6	254	76	3.2
3.6WKFH031.5	31.5	50	151	18.4	25	4.5×10^2	6×10^3	359	76	4.1
3.6WFGH040	40	50	151	13.9	31	8×10^2	1.2×10^4	359	76	4.1
3.6WFGH050	50	50	151	9.24	32	1.8×10^3	2.2×10^4	359	76	4.1
3.6WFGH063	63	50	151	6.93	38	3.2×10^3	4.5×10^4	359	76	4.1
3.6WFGH080	80	50	170	5.47	48	5.1×10^3	7.5×10^4	359	76	4.1
3.6WFGH0100	100	50	212	4.40	62	7.9×10^3	1.2×10^5	359	76	4.1
3.6WFGH0125	125	50	212	3.60	79	1.2×10^4	1.7×10^5	359	76	4.1
3.6WFGH0160	160	50	300	2.16	75	3.4×10^4	4.2×10^5	359	76	4.1
3.6WFGH0200	200	50	300	1.77	95	5.1×10^4	7×10^5	359	76	4.1
3.6WFGH0250	250	50	500	1.13	96	1.3×10^5	1.9×10^6	359	76	4.1
3.6WKGH0315	315	50	852	0.65	89	4.5×10^5	6×10^6	359	76	3.9
3.6WKGH0355	355	50	852	0.51	90	6.4×10^5	8.5×10^6	359	76	3.9
3.6WKGH0400	400	50	960	0.45	100	8.2×10^5	1.1×10^7	359	76	3.9
3.6WKGH0450	450	50	1150	0.38	108	1.2×10^6	1.5×10^7	359	76	3.9

Higher ratings than those listed above can be obtained by using fuse links connected in parallel. Special fixing arrangements for connecting up to three fuse links in parallel are available. Please contact Bussmann application engineers buletechnical@eaton.com for more details. The code designations for these arrangements are given in "How to order" page 8.

7.2 kV - Motor fuse links to British standard dimensions

Specifications

Description

Motor fuse links providing short circuit protection in motor circuits to both the motor starter and cables from the starter to the motor.

Ratings

Voltage: 7.2 kV

Current: 25 - 315 A

Breaking capacity: 40 kA

Agency information

Comply with BS 2692-1.

Time-current curves and cut-off curves

See list page 117 and data on USB at the back of the catalogue.

Features and benefits

- Cool running, low watts loss and power dissipation thanks to the M-effect.
- Silver elements ensuring high conductivity and low power (revenue) loss.
- 100% X-ray, all our medium voltage fuse links are X-rayed ensuring the highest possible standards are maintained.
- Allows motor start current to pass on without degradation of fuse link.

Typical applications

- Motor protection.

Dimensions - mm

Fuse Link Type	A	B	C	D
WFNHO	486	454	403	76
WKNHO	486	454	403	76

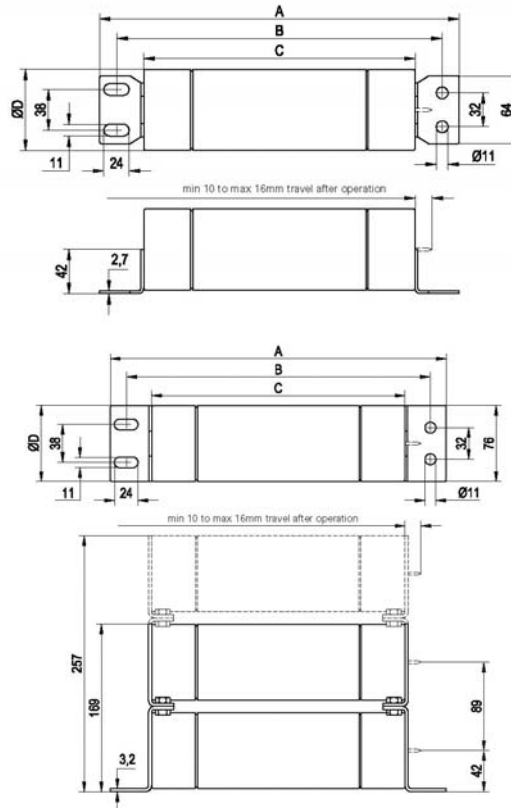

Triple barrel fuse link (3rd barrel shown dotted) with O3 tags. Double barrel fuse link with O2 tags shown in full line.

Part numbers and technical data

Part numbers	Current I_n (A)	Breaking capacity I_b (kA)	Minimum breaking current I_3 (A)	Cold resistance & watts loss in free air		Joule integral (I ² t)		Length mm	Diameter mm	Weight kg
				mΩ	W	Minimum pre-arcing	Maximum operating			
7.2WFNHO25	25	40	84	38.7	34	1.4×10^2	2.1×10^3	403	76	4.4
7.2WFNHO31.5	31.5	40	96	25.5	35	3.1×10^2	4.7×10^3	403	76	4.4
7.2WFNHO40	40	40	107	18.2	40	6.1×10^2	8×10^3	403	76	4.4
7.2WFNHO50	50	40	122	13.3	46	1.2×10^3	1.5×10^4	403	76	4.4
7.2WFNHO63	63	40	133	10.4	56	1.9×10^3	3×10^4	403	76	4.4
7.2WFNHO80	80	40	133	7.30	65	3.8×10^3	5.8×10^4	403	76	4.4
7.2WFNHO100	100	40	262	4.92	69	9.8×10^3	1.3×10^5	403	76	4.4
7.2WFNHO125	125	40	300	2.94	63	2.4×10^4	2.4×10^5	403	76	4.4
7.2WFNHO160	160	40	337	25	72	5×10^4	7×10^5	403	76	4.4
7.2WKNHO200	200	40	500	1.63	90	8.8×10^4	1.3×10^6	403	76	4.4
7.2WKNHO224	224	40	500	1.44	98	1.1×10^5	1.6×10^6	403	76	4.4
7.2WKNHO250	250	40	960	1.11	105	2.2×10^5	1.6×10^6	403	76	4.4
7.2WKNHO315	315	40	960	0.78	107	4.5×10^5	3.1×10^6	403	76	4.4

Higher ratings than those listed above can be obtained by using fuse links connected in parallel. Special fixing arrangements for connecting up to three fuse links in parallel are available. Please contact Bussmann application engineers buletechnical@eaton.com for more details. The code designations for these arrangements are given in "How to order" page 8.

12 kV - Motor fuse links to British standard dimensions

Specifications

Description

Motor fuse links providing short circuit protection in motor circuits to both the motor starter and cables from the starter to the motor.

Ratings

Voltage: 12 kV

Current: 250 - 350 A

Breaking capacity: 56 kA

Agency information

Comply with BS 2692-1.

Time-current curves and cut-off curves

See list page 117 and data on USB at the back of the catalogue.

Features and benefits

- Cool running, low watts loss and power dissipation thanks to the M-effect.
- Silver elements ensuring high conductivity and low power (revenue) loss.
- 100% X-ray, all our medium voltage fuse links are X-rayed ensuring the highest possible standards are maintained.
- Allows motor start current to pass on without degradation of fuse link.

Typical applications

- Motor protection

Dimensions - mm

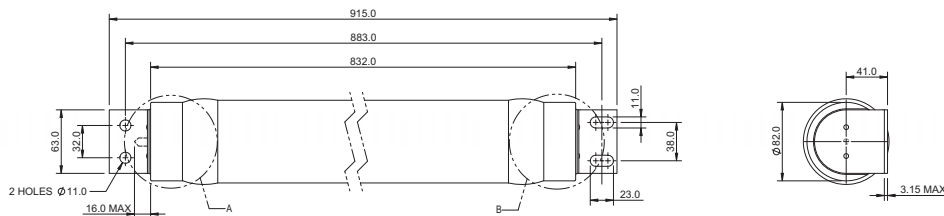

Part numbers and technical data

Part numbers	Current I_n (A)	Breaking capacity I_b (kA)	Minimum breaking current I_3 (A)	Joule integral (I^2t)	
				Minimum pre-arcing 10^3	Maximum operating 10^3
K81ERX250	250	56 kA	1000	300	2000
K81ERX315	315	56 kA	1000	540	3100
K81ERX350	350	56 kA	1000	850	4500

* Lower ratings available 32, 40, 50, 63, 75, 100, 125, 160 and 200 A. Please contact our technical department for further information: buletechnical@eaton.com or 00 44 1509 882 699

3.6 kV - Motor fuse links to DIN Standard dimensions

Specifications

Description

Motor fuse links providing short circuit protection in motor circuits to both the motor starter and cables from the starter to the motor.

Ratings

Voltage: 3.6 kV

Current: 50 - 400 A

Breaking capacity: 50 kA

Agency information

Comply with IEC 60282-1, VDE 0670 part 4 and DIN Dimensional standard DIN 43625.

Time-current curves and cut-off curves

See list page 117 and data on USB at the back of the catalogue.

Features and benefits

- Cool running, low watts loss and power dissipation thanks to the M-effect.
- Silver elements ensuring high conductivity and low power (revenue) loss.
- 100% X-ray, all our medium voltage fuse links are X-rayed ensuring the highest possible standards are maintained.
- Allows motor start current to pass on without degradation of fuse link.

Typical applications

- Motor protection.

Part numbers and technical data

Part numbers	Current I _n (A)	Breaking capacity I _b (kA)	Minimum breaking current I ₃ (A)	Cold resistance & watts loss in free air		Joule integral (I ² t)		Length mm	Diameter mm	Weight kg
				mΩ	W	Minimum pre-arcing	Maximum operating			
3.6WDOSJ50	50	50	180	5.36	20	1.8 x 10 ³	2.4 x 10 ⁴	192	51	1.1
3.6WDOSJ63	63	50	225	3.68	21	3.8 x 10 ³	4.5 x 10 ⁴	192	51	1.1
3.6WDOSJ80	80	50	288	2.88	27	6.3 x 10 ³	8 x 10 ⁴	192	51	1.1
3.6WDOSJ100	100	50	360	2.16	31	9.8 x 10 ³	1.1 x 10 ⁵	192	51	1.1
3.6WDOSJ125	125	50	450	1.73	39	1.5 x 10 ⁴	2.2 x 10 ⁵	192	51	1.1
3.6WFOSJ160	160	50	600	1.28	47	3.1 x 10 ⁴	6.2 x 10 ⁵	192	76	2.1
3.6WFOSJ200	200	50	600	0.94	52	5.7 x 10 ⁴	1.1 x 10 ⁶	192	76	2.1
3.6WDLSJ50	50	50	152	7.73	27	1.8 x 10 ³	2.4 x 10 ⁴	292	51	1.63
3.6WDLSJ63	63	50	171	5.9	32	3.1 x 10 ³	4.5 x 10 ⁴	292	51	1.63
3.6WDLSJ80	80	50	190	4.12	37	6.3 x 10 ³	8 x 10 ⁴	292	51	1.63
3.6WDLSJ100	100	50	190	3.38	46	9.5 x 10 ³	1.2 x 10 ⁵	292	51	1.63
3.6WDLSJ125	125	50	190	2.85	61	1.3 x 10 ⁴	1.8 x 10 ⁵	292	51	1.63
3.6WFLSJ160	160	50	300	1.74	61	3.4 x 10 ⁴	4.1 x 10 ⁵	292	76	3.16
3.6WFLSJ200	200	50	300	1.42	80	5.1 x 10 ⁴	7.2 x 10 ⁵	292	76	3.16
3.6WKLSJ250	250	50	820	0.74	67	1.9 x 10 ⁵	2.4 x 10 ⁶	292	76	3.16
3.6WKLSJ315	315	50	820	0.51	69	4 x 10 ⁵	5 x 10 ⁶	292	76	3.16
3.6WKLSJ400	400	50	820	0.40	90	6.4 x 10 ⁵	7 x 10 ⁶	292	76	3.16

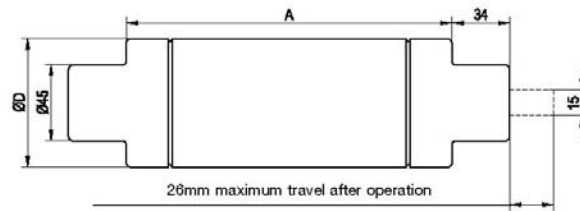

Dimensions - mm

Fuse link reference	Length (A) mm	Diameter (D) mm	Weight Kg
WDOS	192	51	1.1
WFOS	192	76	2.1
WDLS	292	51	1.63
WFLS	292	76	3.16
WKLS	292	76	3.16

7.2 kV - Motor fuse links to DIN Standard dimensions

Specifications

Description

Motor fuse links providing short circuit protection in motor circuits to both the motor starter and cables from the starter to the motor.

Ratings

Voltage: 7.2 kV

Current: 25 - 355A

Breaking capacity: 63 kA

Agency information

Comply with IEC 60282-1, VDE 0670 part 4 and DIN Dimensional standard DIN 43625.

Time-current curves and cut-off curves

See list page 117 and data on USB at the back of the catalogue.

Features and benefits

- Cool running, low watts loss and power dissipation thanks to the M-effect.
- Silver elements ensuring high conductivity and low power (revenue) loss.
- 100% X-ray, all our medium voltage fuse links are X-rayed ensuring the highest possible standards are maintained.
- Allows motor start current to pass on without degradation of fuse link.

Typical applications

- Motor protection.

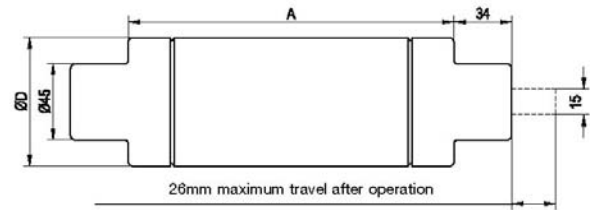

Dimensions - mm

Fuse link reference	Length (A) mm	Diameter (D) mm	Weight Kg
WFMS	442	76	5.2
WKMS	442	76	5.2

Part numbers technical data

Part numbers	Current I _n (A)	Breaking capacity I _b (kA)	Minimum breaking current I ₃ (A)	Cold resistance & watts loss in free air		Joule integral (I ² t)		Length mm	Diameter mm	Weight kg
				mΩ	W	Minimum pre-arcing	Maximum operating			
7.2WFMSJ25	25	63	84	33.9	33	1.4 x 10 ²	2.1 x 10 ³	442	76	5.2
7.2WFMSJ31.5	31.5	63	96	25.4	40	3.1 x 10 ²	4.7 x 10 ³	442	76	5.2
7.2WFMSJ40	40	63	107	17.8	56	6.1 x 10 ²	8 x 10 ³	442	76	5.2
7.2WFMSJ50	50	63	122	14.8	53	1.2 x 10 ³	1.5 x 10 ⁴	442	76	5.2
7.2WFMSJ63	63	63	133	11.6	61	1.9 x 10 ³	3 x 10 ⁴	442	76	5.2
7.2WFMSJ80	80	63	133	8.12	72	3.8 x 10 ³	5.8 x 10 ⁴	442	76	5.2
7.2WFMSJ100	100	63	262	5.33	74	9.8 x 10 ³	1.3 x 10 ⁵	442	76	5.2
7.2WFMSJ125	125	63	300	3.19	70	2.4 x 10 ⁴	2.4 x 10 ⁵	442	76	5.2
7.2WFMSJ160	160	63	337	2.23	79	5 x 10 ⁴	7 x 10 ⁵	442	76	5.2
7.2WKMSJ200	200	63	500	1.79	99	8.8 x 10 ⁴	1.3 x 10 ⁶	442	76	5.2
7.2WKMSJ224	224	63	500	1.59	100	1.1 x 10 ⁵	1.6 x 10 ⁶	442	76	5.2
7.2WKMSJ250	250	63	960	1.23	107	2.2 x 10 ⁵	1.6 x 10 ⁶	442	76	5.2
7.2WKMSJ315	315	63	960	0.87	120	4.5 x 10 ⁵	3.1 x 10 ⁶	442	76	5.2
7.2WKMSJ355	355	63	1000	0.72	125	6.4 x 10 ⁵	3.9 x 10 ⁶	442	76	5.2

2.75 kV - Motor fuse links to USA Dimensions

Specifications

Description

R-rated medium voltage current limiting fuse links for motor protection.

Ratings

Voltage: 2.75 kV

Current: 2 - 24 R

Breaking capacity: 60 kA

Agency information

IEEE standards.

Features and benefits

- Cool running, low watts loss and power dissipation thanks to the M-effect.
- Silver elements ensuring high conductivity and low power (revenue) loss.
- 100% X-ray, all our medium voltage fuse links are X-rayed ensuring the highest possible standards are maintained.
- Allows motor start current to pass on without degradation of fuse link.

Typical applications

- Motor protection.

Dimensions

Fuse link reference	Length mm	Diameter mm	Weight Kg
VFRHA	276	76	2.5
VKRHA	276	76	2.5
VKRHK	276	76	5.2

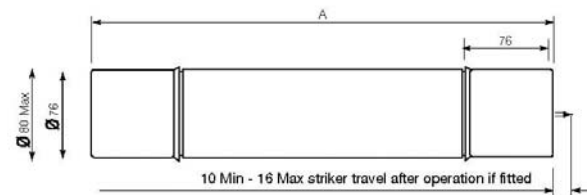

A Tags (ferrule)

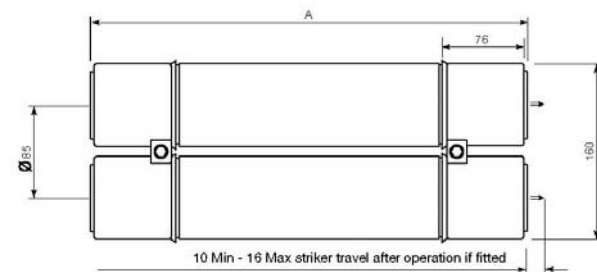

K Tags (double barrel fuse links)

Part numbers and technical data

Part numbers	Breaking capacity I_b (kA)	Minimum breaking current I_3 (A)	Cold resistance & watts loss in free air		Joule integral (I^2t)		Length mm	Diameter mm	Weight kg
			mΩ	W	Minimum Pre-arcing	Maximum oper- ating			
2.75VFRHA2R	60	180	6.15	52	8.1×10^3	2.8×10^4	276	76	2.5
2.75VFRHA3R	60	229	44	57	1.9×10^4	7.5×10^4	276	76	2.5
2.75VFRHA4R	60	257	2.69	62	4.2×10^4	1.4×10^5	276	76	2.5
2.75VFRHA6R	60	525	1.62	65	3.9×10^4	3.4×10^5	276	76	2.5
2.75VKRHA9R	60	500	1.15	70	8.8×10^4	8.4×10^5	276	76	2.5
2.75VKRHA12R	60	500	13	80	1.1×10^5	1.2×10^6	276	76	2.5
2.75VKRHK18R	60	500	0.58	140	3.5×10^5	3.2×10^6	276	76	5.2
2.75VKRHK24R	60	500	0.51	156	4.5×10^5	5.5×10^6	276	76	5.2

5.5 kV - Motor fuse links to USA Dimensions

Specifications

Description

R-rated medium voltage current limiting fuse links for motor protection.

Ratings

Voltage: 5.5 kV

Current: 2 - 24 R

Breaking capacity: 60 kA

Agency information

IEEE standards.

Features and benefits

- Cool running, low watts loss and power dissipation thanks to the M-effect ensuring high levels of substation utilisation.
- Silver elements ensuring high conductivity and low power (revenue) loss.
- 100% X-ray, all our medium voltage fuse links are X-rayed ensuring the highest possible standards are maintained.

Typical applications

- Motor protection.

Dimensions

Fuse link reference	Length mm	Diameter mm	Weight Kg
VFNHA	403	76	3.8
VKNHA	403	76	3.8
VKNHK	403	76	7.8

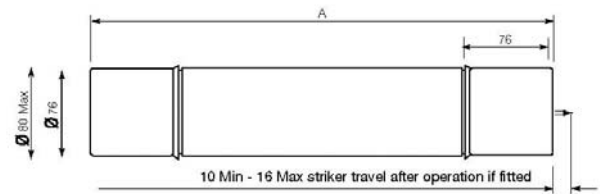

A Tags (ferrule)

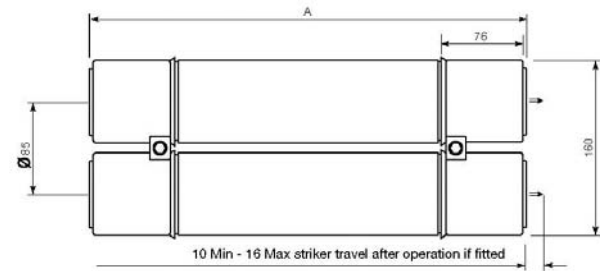

K Tags (double barrel fuse links)

Part numbers and technical data

Part numbers	Breaking capacity I_1 (kA)	Minimum breaking current I_3 (A)	Cold resistance & watts loss in free air				Joule integral (I^2t)		Length mm	Diameter mm	Weight kg
			mΩ	W	Minimum pre-arcing	Maximum operating					
5.5VFNHA2R	60	180	8.35	70	8.1×10^3	2.8×10^4	403	76	3.8		
5.5VFNHA3R	60	229	5.48	77	1.9×10^4	7.9×10^4	403	76	3.8		
5.5VFNHA4R	60	257	3.65	85	4.2×10^4	1.6×10^5	403	76	3.8		
5.5VFNHA6R	60	525	2.31	91	3.9×10^4	3.6×10^5	403	76	3.8		
5.5VKNHA9R	60	500	1.63	99	8.8×10^4	8.8×10^5	403	76	3.8		
5.5VKNHA12R	60	500	1.45	110	1.1×10^5	1.3×10^6	403	76	3.8		
5.5VKNHK18R	60	500	0.82	198	3.5×10^5	3.4×10^6	403	76	7.8		
5.5VKNHK24R	60	500	0.73	220	4.5×10^5	5.8×10^6	403	76	7.8		

Medium voltage and auxiliary transformer fuse links



Introduction to medium voltage and auxiliary transformer fuse links	35
Medium voltage and auxiliary transformer	
1.1 kV	36
3.6 kV	37
5.5 kV - Type E	38
7.2 kV	39
12 kV	40
15.5 kV	41
17.5 kV	42
24 kV	43
36 kV	44
Type CAV	
3.6 kV	45
5.5 kV	46
7.2 kV	47
12 kV	48
15.5 kV	49
17.5 kV	50
24 kV	51
36 kV	52
38 kV	53

Introduction to medium voltage and auxiliary transformer fuse links

- British standard voltage and auxiliary transformer (VT) fuse links.
- A range of voltage transformer primary fuse links to BS 2692-1 and IEC 60282-1.
- Wide range of ratings from 1 kV to 36 kV.
- 3.15 Amp industry standard current ratings.
- CAV range with ratings from 3.6 kV to 38 kV.

Bussmann voltage and auxiliary transformer fuse links

Bussmann manufactures a wide range of voltage transformer (VT) fuse links. In North America they are referred to as 'potential transformer fuse links'. These fuse links are designed for use in the primary side of voltage transformers to provide system isolation in the event of faults occurring in the transformer circuit.

Voltage transformer fuse links have a preferred current rating of 3.15A. Experience has shown that there is a risk of spurious operation by transient overcurrents where lower current ratings are used. In addition, in order to minimise the risk of deterioration of the fine fuse elements caused by corona, it is desirable to mount the fuse links so that the earthed metal is not in the immediate vicinity of the part of the barrel between the ferrules.

Higher current and 'E' ratings are available for special applications, including auxiliary transformers.

A range of VT fuse links with a breaking capacity of 200 kA for use at the output terminals of large turbo alternators can also be ordered. For further information, please contact Bussmann application engineers: buletechnical@eaton.com.

Types prefixed 'A' or 'N' are suitable for use indoors in air only. Types prefixed 'O' may be used under oil.

Application

Small rated fuse links for protection of voltage and auxiliary transformers. Back-up protection up to 3.15 A and voltages from 1.1 kV to 36 kV.



1.1 kV - Voltage and auxiliary transformer fuse links

Specifications

Description

Voltage transformer fuse links, suitable for the protection of auxiliary transformers.

Ratings

Voltage: 1.1 kV

Current: 2 - 6.3 A

Breaking capacity: 50 kA

Agency information

Comply with BS 2692-1 and IEC 60282-1.

Time-current curves and cut-off curves

See list page 117 and data on USB at the back of the catalogue.

Features and benefits

- Cool running, low watts loss and power dissipation thanks to the M-effect ensuring high levels of substation utilisation.
- Silver elements ensuring high conductivity and low power (revenue) loss.
- 100% X-ray, all our medium voltage fuse links are X-rayed ensuring the highest possible standards are maintained.

Typical applications

- Protection of auxiliary transformers.

Part numbers and technical data

Part numbers	Current I_n (A)	Breaking capacity I_b (kA)	Cold resistance $m\Omega$	Joule integral (I^2t)		Length mm	Diameter mm	Weight kg
				Minimum Pre-arcing	Maximum operating			
1.1NBUN*2	2	50	0.15	6.3×10^0	1.8×10^1	86	25.4	0.12
1.1NBUN*3.15	3.15	50	0.11	1.2×10^1	3.4×10^1	86	25.4	0.12
1.1NBUN*6.3	6.3	50	0.07	3.2×10^1	9.2×10^1	86	25.4	0.12

* The last letter of the ordering code on these items is normally either "A" or "22", please refer to how to order page 8.

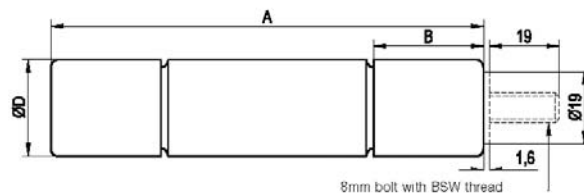

Ferrule fuse links tag type 'A' shown in full lines and '22': tag shown in dotted lines

Dimensions - mm

Fuse link reference	A (mm)	B (mm)	D (mm)
NBUN	86	17.5	25.4

3.6 kV - Voltage and auxiliary transformer fuse links

Specifications

Description

Voltage transformer fuse links. suitable for the protection of auxiliary transformers.

Ratings

Voltage: 3.6 kV

Current: 3.15 - 10A

Breaking capacity: 50 kA

Agency information

Comply with BS 2692-1 and IEC 60282-1.

Time-current curves and cut-off curves

See list page 117 and data on USB at the back of the catalogue.

Features and benefits

- Cool running, low watts loss and power dissipation thanks to the M-effect ensuring high levels of substation utilisation.
- Silver elements ensuring high conductivity and low power (revenue) loss.
- 100% X-ray, all our medium voltage fuse links are X-rayed ensuring the highest possible standards are maintained.

Typical applications

- Protection of auxiliary transformers.

Part numbers and technical data

Part numbers	Current I_n (A)	Breaking capacity I_b (kA)	Cold resistance mΩ	Joule integral (I^2t)		Length mm	Diameter mm	Weight kg
				Minimum pre-arcing	Maximum operating			
3.6ABWN*3.15	3.15	50	0.36	6.3×10^0	1.8×10^1	142	25.4	0.19
3.6ABWN*6.3	6.3	50	0.12	4.8×10^1	3.1×10^2	142	25.4	0.19
3.6ABCN*3.15	3.15	50	0.36	6.3×10^0	1.8×10^1	195	25.4	0.245
3.6ABCN*6.3	6.3	50	0.12	4.8×10^1	3.1×10^2	195	25.4	0.245
3.6ABCN*10	10	50	0.08	1.1×10^2	7×10^2	195	25.4	0.245

* The last letter of the ordering code on these items is normally either "A" or "22"; please refer to how to order page 8.

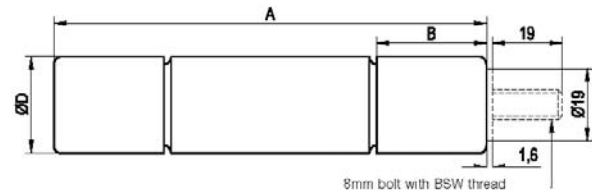

Ferrule fuse links tag type 'A' shown in full lines and '22': tag shown in dotted lines

Dimensions - mm

Fuse link reference	A (mm)	B (mm)	D (mm)
ABWN	142	30	25.4
ABCN	195	30	25.4

5.5 kV - Type E Voltage transformer fuse links

Specifications

Description

Voltage transformer fuse links. suitable for the protection of auxiliary transformers.

Ratings

Voltage: 5.5 kV

Current: 0.5 - 5A

Breaking capacity: 50 kA

Agency information

Comply with BS 2692-1 and IEC 60282-1.

Time-current curves and cut-off curves

See list page 117 and data on USB at the back of the catalogue.

Features and benefits

- Cool running, low watts loss and power dissipation thanks to the M-effect ensuring high levels of substation utilisation.
- Silver elements ensuring high conductivity and low power (revenue) loss.
- 100% X-ray, all our medium voltage fuse links are X-rayed ensuring the highest possible standards are maintained.

Typical applications

- Protection of auxiliary transformers.

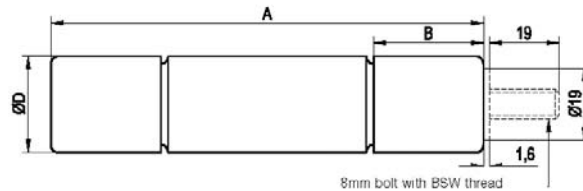

Ferrule fuse links tag type 'A' shown in full lines and '22': tag shown in dotted lines

Dimensions - mm

Fuse link reference	A (mm)	B (mm)	D (mm)
ABWNA	142	30	25.4
AMWNA	142	16	20.6

Part numbers and technical data

Part numbers	Current I_n (A)	Breaking capacity I_b (kA)	Cold resistance mΩ	Joule integral (I ² t)		Length mm	Diameter mm	Weight kg
				Minimum pre-arcing	Maximum operating			
5.5AMWNA0.5E	0.5	50	32.5	1.2×10^0	3.5×10^0	142	20.6	0.114
5.5AMWNA1E	1	50	16	5×10^0	1.4×10^1	142	20.6	0.114
5.5AMWNA2E	2	50	0.58	4×10^0	1.2×10^1	142	20.6	0.114
5.5AMWNA3E	3	50	0.32	1.8×10^1	1.1×10^2	142	20.6	0.114
5.5AMWNA4E	4	50	0.19	4.6×10^1	3×10^2	142	20.6	0.114
5.5AMWNA5E	5	50	0.15	7.9×10^1	5.1×10^2	142	20.6	0.114
5.5ABWNA0.5E	0.5	50	50.2	0.49×10^0	1.4×10^0	142	25.4	0.19
5.5ABWNA1E	1	50	25.1	2×10^0	5.7×10^0	142	25.4	0.19
5.5ABWNA2E	2	50	18	1.2×10^0	3.4×10^0	142	25.4	0.19
5.5ABWNA3E	3	50	0.47	6.3×10^0	1.8×10^1	142	25.4	0.19
5.5ABWNA5E	5	50	0.2	3.2×10^1	2×10^2	142	25.4	0.19

7.2 kV - Voltage and auxiliary transformer fuse links

Specifications

Description

Voltage transformer fuse links, suitable for the protection of auxiliary transformers.

Ratings

Voltage: 7.2 kV

Current: 3.15 - 6.3A

Breaking capacity: 45 kA

Agency information

Comply with BS 2692-1 and IEC 60282-1.

Time-current curves and cut-off curves

See list page 117 and data on USB at the back of the catalogue.

Features and benefits

- Cool running, low watts loss and power dissipation thanks to the M-effect ensuring high levels of substation utilisation.
- Silver elements ensuring high conductivity and low power (revenue) loss.
- 100% X-ray, all our medium voltage fuse links are X-rayed ensuring the highest possible standards are maintained.

Typical applications

- Protection of auxiliary transformers.

Part numbers and technical data

Part numbers	Current I_n (A)	Breaking capacity I_b (kA)	Cold resistance mΩ	Joule integral (I^2t)		Length mm	Diameter mm	Weight kg
				Minimum Pre-arcing	Maximum operating			
7.2ABWN*3.15	3.15	45	0.61	6.3×10^0	4×10^1	142	25.4	0.19
7.2ABWN*6.3	6.3	45	0.24	4.8×10^1	3.1×10^2	142	25.4	0.19
7.2ABCN*3.15	3.15	45	0.61	6.3×10^0	4×10^1	195	25.4	0.245
7.2ABCN*6.3	6.3	45	0.24	4.8×10^1	3.1×10^2	195	25.4	0.245
7.2AMWNA0.5E	0.5	50	47.5	0.2×10^0	1×10^0	142	20.6	0.19
7.2AMWNA1E	1	50	23.3	1.2×10^0	4.8×10^0	142	20.6	0.19
7.2AMWNA2E	2	50	1.37	1.7×10^0	8.8×10^0	142	20.6	0.19
7.2AMWNA3E	3	50	0.77	4×10^0	2.7×10^1	142	20.6	0.19
7.2AMWNA4E	4	50	0.43	1.2×10^1	5.1×10^1	142	20.6	0.19
7.2AMWNA5E	5	50	0.27	2.8×10^1	1.4×10^2	142	20.6	0.19
7.2OBCN*3.15	3.15	45	0.61	6.3×10^0	4×10^1	195	25.4	0.245
7.2OBCN*6.3	6.3	45	0.24	4.8×10^1	3.1×10^2	195	25.4	0.245
7.2OBWN*3.15	3.15	45	0.61	6.3×10^0	4×10^1	142	25.4	0.19
7.2OBWN*6.3	6.3	45	0.24	4.8×10^1	3.1×10^2	142	25.4	0.19

* The last letter of the ordering code on these items is normally either "A" or "22"; please refer to how to order page 8.

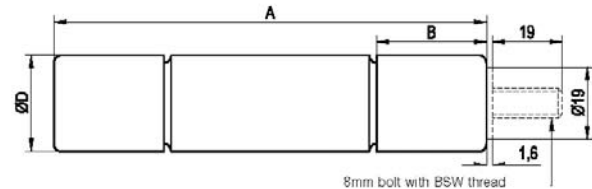

Ferrule fuse links tag type 'A' shown in full lines and '22': tag shown in dotted lines

Dimensions - mm

Fuse link reference	A (mm)	B (mm)	D (mm)
ABWN*	142	30	25.4
ABCN*	195	30	25.4
AMWN	142	16	20.6
OBCN*	195	30	25.4
OBWN*	142	30	25.4

12 kV - Voltage and auxiliary transformer fuse links

Specifications

Description

Voltage transformer fuse links. suitable for the protection of auxiliary transformers.

Ratings

Voltage: 12 kV

Current: 3.15A

Breaking capacity: 45 kA

Agency information

Comply with BS 2692-1 and IEC 60282-1.

Time-current curves and cut-off curves

See list page 117 and data on USB at the back of the catalogue.

Features and benefits

- Cool running, low watts loss and power dissipation thanks to the M-effect ensuring high levels of substation utilisation.
- Silver elements ensuring high conductivity and low power (revenue) loss.
- 100% X-ray, all our medium voltage fuse links are X-rayed ensuring the highest possible standards are maintained.

Typical applications

- Protection of auxiliary transformers.

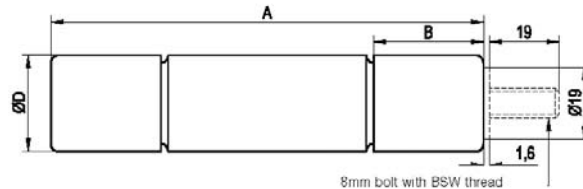

Ferrule fuse links tag type 'A' shown in full lines and '22': tag shown in dotted lines

Dimensions - mm

Fuse link reference	A (mm)	B (mm)	D (mm)
ABCN*	195	30	25.4
OBCN*	195	30	25.4

Part numbers and technical data

Part numbers	Current I_n (A)	Breaking capacity I_b (kA)	Cold resistance $m\Omega$	Joule integral (I^2t)		Length mm	Diameter mm	Weight kg
				Minimum pre-arcing	Maximum operating			
12ABCN*3.15	3.15	45	1.21	6.3×10^0	1.8×10^1	195	25.4	0.245
12OBCN*3.15	3.15	45	1.21	6.3×10^0	1.8×10^1	195	25.4	0.245

* The last letter of the ordering code on these items is normally either "A" or "22," please refer to how to order page 8.

15.5 kV - Voltage and auxiliary transformer fuse links

Specifications

Description

Voltage transformer fuse links, suitable for the protection of auxiliary transformers.

Ratings

Voltage: 15.5 kV

Current: 3.15A

Breaking capacity: 32 kA

Agency information

Comply with BS 2692-1 and IEC 60282-1.

Time-current curves and cut-off curves

See list page 117 and data on USB at the back of the catalogue.

Features and benefits

- Cool running, low watts loss and power dissipation thanks to the M-effect ensuring high levels of substation utilisation.
- Silver elements ensuring high conductivity and low power (revenue) loss.
- 100% X-ray, all our medium voltage fuse links are X-rayed ensuring the highest possible standards are maintained.

Typical applications

- Protection of auxiliary transformers.

Part numbers and technical data

Part numbers	Current I_n (A)	Breaking capacity I_b (kA)	Cold resistance mΩ	Joule integral (I^2t)		Length mm	Diameter mm	Weight kg
				Minimum pre-arcing	Maximum operating			
15.5ABFN*3.15	3.15	32	1.24	6.3×10^0	4×10^1	254	25.4	0.31
15.50BFN*3.15	3.15	32	1.24	6.3×10^0	4×10^1	254	25.4	0.31

* The last letter of the ordering code on these items is normally either "A" or "22"; please refer to how to order page 8.

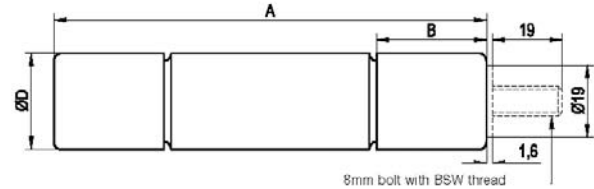

Ferrule fuse links tag type 'A' shown in full lines and '22': tag shown in dotted lines

Dimensions - mm

Fuse link reference	A (mm)	B (mm)	D (mm)
ABFN*	254	30	25.4
OBFN*	254	30	25.4

17.5 kV - Voltage and auxiliary transformer fuse links

Specifications

Description

Voltage transformer fuse links. suitable for the protection of auxiliary transformers.

Ratings

Voltage: 17.5 kV

Current: 3.15A

Breaking capacity: 35 kA

Agency information

Comply with BS 2692-1 and IEC 60282-1.

Time-current curves and cut-off curves

See list page 117 and data on USB at the back of the catalogue.

Features and benefits

- Cool running, low watts loss and power dissipation thanks to the M-effect ensuring high levels of substation utilisation.
- Silver elements ensuring high conductivity and low power (revenue) loss.
- 100% X-ray, all our medium voltage fuse links are X-rayed ensuring the highest possible standards are maintained.

Typical applications

- Protection of auxiliary transformers.

Part numbers and technical data

Part numbers	Current I_n (A)	Breaking capacity I_b (kA)	Cold resistance mΩ	Joule integral (I^2t)		Length mm	Diameter mm	Weight kg
				Minimum Pre-arcing	Maximum operating			
17.5ABGN*3.15	3.15	35	1.45	6.3×10^0	4×10^1	359	25.4	0.43
17.5OBGN*3.15	3.15	35	1.45	6.3×10^0	4×10^1	359	25.4	0.43

* The last letter of the ordering code on these items is normally either "A" or "22"; please refer to how to order page 8.

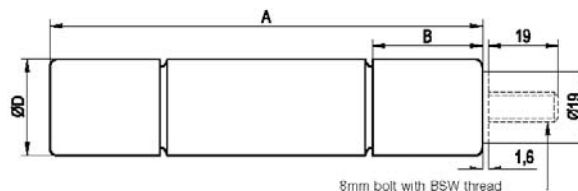

Ferrule fuse links tag type 'A' shown in full lines and '22': tag shown in dotted lines

Dimensions - mm

Fuse link reference	A (mm)	B (mm)	D (mm)
ABGN*	359	30	25.4
OBGN*	359	30	25.4

24 kV - Voltage and auxiliary transformer fuse links

Specifications

Description

Voltage transformer fuse links. suitable for the protection of auxiliary transformers.

Ratings

Voltage: 24 kV

Current: 3.15A

Breaking capacity: 25 kA

Agency information

Comply with BS 2692-1 and IEC 60282-1.

Time-current curves and cut-off curves

See list page 117 and data on USB at the back of the catalogue.

Features and benefits

- Cool running, low watts loss and power dissipation thanks to the M-effect ensuring high levels of substation utilisation.
- Silver elements ensuring high conductivity and low power (revenue) loss.
- 100% X-ray, all our medium voltage fuse links are X-rayed ensuring the highest possible standards are maintained.

Typical applications

- Protection of auxiliary transformers.

Part numbers and technical data

Part numbers	Current I_n (A)	Breaking capacity I_b (kA)	Cold resistance mΩ	Joule integral (I^2t)		Length mm	Diameter mm	Weight kg
				Minimum pre-arcing	Maximum operating			
24ABGN*3.15	3.15	25	2	6.3×10^9	4×10^1	359	25.4	0.43
24OBGN*3.15	3.15	25	2	6.3×10^9	4×10^1	359	25.4	0.43

* The last letter of the ordering code on these items is normally either "A" or "22", please refer to how to order page 8.

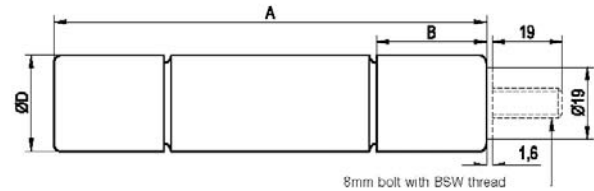

Ferrule fuse links tag type 'A' shown in full lines and '22': tag shown in dotted lines

Dimensions - mm

Fuse link reference	A (mm)	B (mm)	D (mm)
ABGN*	359	30	25.4
OBGN*	359	30	25.4

36 kV - Voltage and auxiliary transformer fuse links

Specifications

Description

Voltage transformer fuse links. suitable for the protection of auxiliary transformers.

Ratings

Voltage: 36 kV

Current: 3.15A

Breaking capacity: 31.5 kA

Agency information

Comply with BS 2692-1 and IEC 60282-1.

Time-current curves and cut-off curves

See list page 117 and data on USB at the back of the catalogue.

Features and benefits

- Cool running, low watts loss and power dissipation thanks to the M-effect ensuring high levels of substation utilisation.
- Silver elements ensuring high conductivity and low power (revenue) loss.
- 100% X-ray, all our medium voltage fuse links are X-rayed ensuring the highest possible standards are maintained.

Typical applications

- Protection of auxiliary transformers.

Part numbers and technical data

Part numbers	Current I_n (A)	Breaking capacity I_b (kA)	Cold resistance $m\Omega$	Joule integral (I^2t)		Length mm	Diameter mm	Weight kg
				Minimum Pre-arcing	Maximum operating			
36OBGN*3.15	3.15	31.5	25	1.2×10^1	7.7×10^1	359	25.4	0.43

* The last letter of the ordering code on these items is normally either "A" or "22", please refer to how to order page 8.

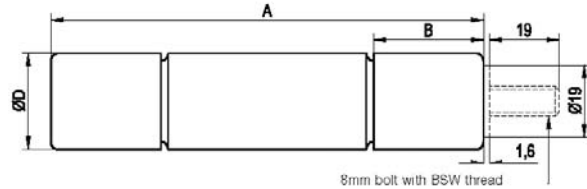

Ferrule fuse links tag type 'A' shown in full lines and '22': tag shown in dotted lines

Dimensions - mm

Fuse link reference	A (mm)	B (mm)	D (mm)
OBGN*	359	30	25.4

3.6 kV - Voltage and auxiliary transformer type CAV Fuse links

Specifications

Description

Voltage transformer fuse links. suitable for the protection of auxiliary transformers.

Ratings

Voltage: 3.6 kV

Current: 2A

Breaking capacity: 50 kA

Agency information

Comply with IEC 60282-1.

Time-current curves and cut-off curves

See list page 117 and data on USB at the back of the catalogue.

Features and benefits

- Cool running, low watts loss and power dissipation thanks to the M-effect ensuring high levels of substation utilisation.
- Silver elements ensuring high conductivity and low power (revenue) loss.
- 100% X-ray, all our medium voltage fuse links are X-rayed ensuring the highest possible standards are maintained.

Typical applications

- Protection of auxiliary transformers.

Part numbers and technical data

Part numbers	Current I_n (A)	Breaking capacity I_b (kA)	Cold resistance mΩ	Joule integral (I^2t)		Length mm	Diameter mm	Weight kg
				Minimum pre-arcing	Maximum operating			
3.6CAV2	2	50	0.49	6.2×10^0	1.8×10^1	220	41.3	0.7

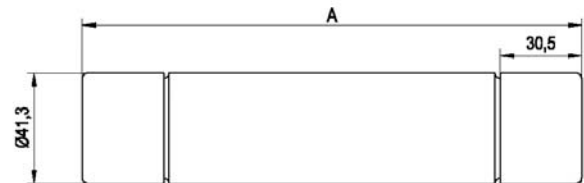

Dimensions - mm

Fuse link reference	A (mm)
3.6CAV	220

5.5 kV - Voltage and auxiliary transformer type CAV Fuse links

Specifications

Description

Voltage transformer fuse links. suitable for the protection of auxiliary transformers.

Ratings

Voltage: 5.5 kV

Current: 0.5 - 15A

Breaking capacity: 50 kA

Agency information

Comply with IEC 60282-1.

Time-current curves and cut-off curves

See list page 117 and data on USB at the back of the catalogue.

Features and benefits

- Cool running, low watts loss and power dissipation thanks to the M-effect ensuring high levels of substation utilisation.
- Silver elements ensuring high conductivity and low power (revenue) loss.
- 100% X-ray, all our medium voltage fuse links are X-rayed ensuring the highest possible standards are maintained.

Typical applications

- Protection of auxiliary transformers.

Part numbers and technical data

Part numbers	Current I_n (A)	Breaking capacity I_b (kA)	Cold resistance mΩ	Joule integral (I^2t)		Length mm	Diameter mm	Weight kg
				Minimum Pre-arcing	Maximum operating			
5.5CAVH0.5E	0.5	50	12.1	1.4×10^1	9×10^1	187	41.3	0.6
5.5CAVH1E	1	50	12.1	1.4×10^1	9×10^1	187	41.3	0.6
5.5CAVH2E	2	50	0.39	1.8×10^1	1.1×10^2	187	41.3	0.6
5.5CAV15E	15	50	0.49	5.5×10^2	3.5×10^3	187	41.3	0.6

CAV fuse links are suitable for indoor use in air only.

Type CAVH fuse links are fitted with striker pins which may be used for indication purposes.



Shown with striker fitted.

Dimensions - mm

Fuse link reference	A (mm)
CAV and CAVH	187

7.2 kV - Voltage and auxiliary transformer type CAV Fuse links

Specifications

Description

Voltage transformer fuse links, suitable for the protection of auxiliary transformers.

Ratings

Voltage: 7.2 kV

Current: 2 - 10A

Breaking capacity: 40 kA

Agency information

Comply with IEC 60282-1.

Time-current curves and cut-off curves

See list page 117 and data on USB at the back of the catalogue.

Features and benefits

- Cool running, low watts loss and power dissipation thanks to the M-effect ensuring high levels of substation utilisation.
- Silver elements ensuring high conductivity and low power (revenue) loss.
- 100% X-ray, all our medium voltage fuse links are X-rayed ensuring the highest possible standards are maintained.

Typical applications

- Protection of auxiliary transformers.

Part numbers and technical data

Part numbers	Current I_n (A)	Breaking capacity I_b (kA)	Cold resistance mΩ	Joule integral (I^2t)		Length mm	Diameter mm	Weight kg
				Minimum Pre-arcing	Maximum operating			
7.2CAV2	2	40	0.89	6.2×10^0	1.8×10^1	220	41.3	0.7
7.2CAV4	4	40	0.50	2×10^1	5.7×10^1	220	41.3	0.7
7.2CAV6	6	40	0.32	4.8×10^1	1.4×10^2	220	41.3	0.7
7.2CAV10	10	40	0.22	1.1×10^2	3.2×10^2	220	41.3	0.7

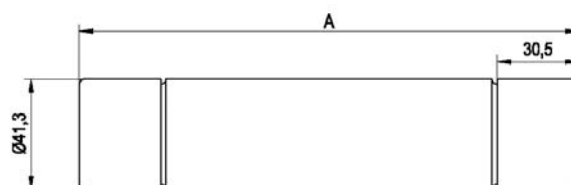

Dimensions - mm

Fuse link reference	A (mm)
CAV	220

12 kV - Voltage and auxiliary transformer type CAV Fuse links

Specifications

Description

Voltage transformer fuse links. suitable for the protection of auxiliary transformers.

Ratings

Voltage: 12 kV

Current: 2A

Breaking capacity: 40 kA

Agency information

Comply with IEC 60282-1

Time-current curves and cut-off curves

See list page 117 and data on USB at the back of the catalogue.

Features and benefits

- Cool running, low watts loss and power dissipation thanks to the M-effect ensuring high levels of substation utilisation.
- Silver elements ensuring high conductivity and low power (revenue) loss.
- 100% X-ray, all our medium voltage fuse links are X-rayed ensuring the highest possible standards are maintained.

Typical applications

- Protection of auxiliary transformers.

Part numbers and technical data

Part numbers	Current I_n (A)	Breaking capacity I_b (kA)	Cold resistance $m\Omega$	Joule integral (I^2t)		Length mm	Diameter mm	Weight kg
				Minimum pre-arcing	Maximum operating			
12CAV2	2	40	1.34	6.2×10^0	1.8×10^1	220	41.3	0.7

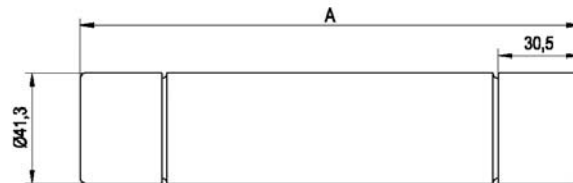

Dimensions - mm

Fuse link reference	A (mm)
CAV	220

15.5 kV - Voltage and auxiliary transformer type CAV Fuse links

Specifications

Description

Voltage transformer fuse links. suitable for the protection of auxiliary transformers.

Ratings

Voltage: 15.5 kV

Current: 0.5 - 7 A

Breaking capacity: 80 kA

Agency information

Comply with IEC 60282-1.

Time-current curves and cut-off curves

See list page 117 and data on USB at the back of the catalogue.

Features and benefits

- Cool running, low watts loss and power dissipation thanks to the M-effect ensuring high levels of substation utilisation.
- Silver elements ensuring high conductivity and low power (revenue) loss.
- 100% X-ray, all our medium voltage fuse links are X-rayed ensuring the highest possible standards are maintained.

Typical applications

- Protection of auxiliary transformers.

Part numbers and technical data

Part numbers	Current I_n (A)	Breaking capacity I_b (kA)	Cold resistance m Ω	Joule integral (I^2t)		Length mm	Diameter mm	Weight kg
				Minimum pre-arcing	Maximum operating			
15.5CAV0.5E	0.5	80	151	0.5×10^0	1.5×10^0	327	41.3	0.9
15.5CAV1E	1	80	75.4	2×10^0	5.8×10^0	327	41.3	0.9
15.5CAV2E	2	80	32.3	1.2×10^0	3.5×10^0	327	41.3	0.9
15.5CAV3E	3	80	16.2	4.8×10^0	1.4×10^1	327	41.3	0.9
15.5CAV5E	5	80	0.66	2×10^1	1.3×10^2	327	41.3	0.9
15.5CAV7E	7	80	0.38	7.1×10^1	4.5×10^2	327	41.3	0.9
15.5CAVH0.5E	0.5	80	30.1	1.4×10^1	9×10^1	327	41.3	0.9
15.5CAVH1E	1	80	30.1	1.4×10^1	9×10^1	327	41.3	0.9
15.5CAVH2E	2	80	0.95	1.8×10^1	1.1×10^2	327	41.3	0.9

CAV fuse links are suitable for indoor use in air only.

Type CAVH fuse links are fitted with striker pins which may be used for indication purposes.

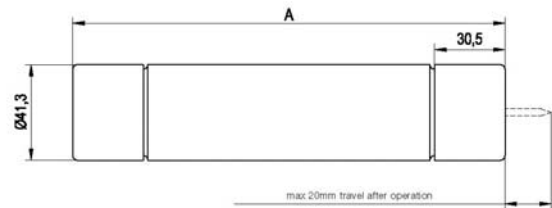

Dimensions - mm

Fuse link reference	A (mm)
CAV and CAVH	327

17.5 kV - Voltage and auxiliary transformer type CAV Fuse links

Specifications

Description

Voltage transformer fuse links. suitable for the protection of auxiliary transformers.

Ratings

Voltage: 17.5 kV

Current: 2 - 10 A

Breaking capacity: 40 kA

Agency information

Comply with IEC 60282-1.

Time-current curves and cut-off curves

See list page 117 and data on USB at the back of the catalogue.

Features and benefits

- Cool running, low watts loss and power dissipation thanks to the M-effect ensuring high levels of substation utilisation.
- Silver elements ensuring high conductivity and low power (revenue) loss.
- 100% X-ray, all our medium voltage fuse links are X-rayed ensuring the highest possible standards are maintained.

Typical applications

- Protection of auxiliary transformers.

Part numbers and technical data

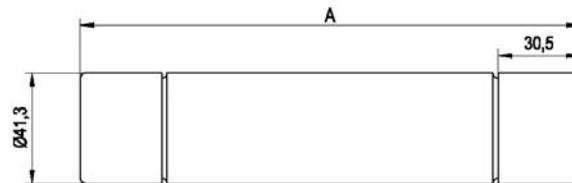

Dimensions - mm

Fuse link reference	A (mm)
CAV	220

Part numbers	Current I_n (A)	Breaking capacity I_b (kA)	Cold resistance $m\Omega$	Joule integral (I^2t)		Length mm	Diameter mm	Weight kg
				Minimum pre-arcing	Maximum operating			
17.5CAV2	2	40	1.69	6.3×10^0	1.8×10^1	220	41.3	0.7
17.5CAV4	4	40	0.61	4.8×10^1	1.4×10^2	220	41.3	0.7
17.5CAV6	6	40	0.36	1.4×10^2	4×10^2	220	41.3	0.7
17.5CAV10	10	40	0.24	3.2×10^2	9.2×10^2	220	41.3	0.7

24 kV - Voltage and auxiliary transformer type CAV Fuse links

Specifications

Description

Voltage transformer fuse links. suitable for the protection of auxiliary transformers.

Ratings

Voltage: 24 kV

Current: 2 - 4A

Breaking capacity: 40 kA

Agency information

Comply with IEC 60282-1.

Time-current curves and cut-off curves

See list page 117 and data on USB at the back of the catalogue.

Features and benefits

- Cool running, low watts loss and power dissipation thanks to the M-effect ensuring high levels of substation utilisation.
- Silver elements ensuring high conductivity and low power (revenue) loss.
- 100% X-ray, all our medium voltage fuse links are X-rayed ensuring the highest possible standards are maintained.

Typical applications

- Protection of auxiliary transformers.

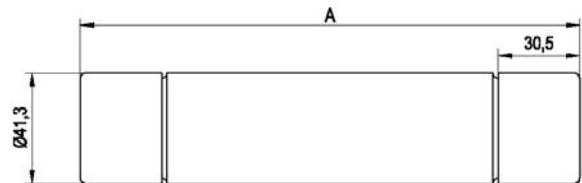

Dimensions - mm

Fuse link reference	A (mm)
CAV	340

Part numbers and technical data

Part numbers	Current I_n (A)	Breaking capacity I_b (kA)	Cold resistance mΩ	Joule integral (I^2t)		Length mm	Diameter mm	Weight kg
				Minimum pre-arcing	Maximum operating			
24CAV2	2	40	2.54	6.2×10^9	1.8×10^1	340	41.3	1
24CAV3	3	40	1.43	2×10^1	5.7×10^1	340	41.3	1
24CAV4	4	40	0.92	4.8×10^1	1.4×10^2	340	41.3	1

36 kV - Voltage transformer and auxiliary type CAV Fuse links

Specifications

Description

Voltage transformer fuse links. suitable for the protection of auxiliary transformers.

Ratings

Voltage: 36 kV

Current: 2 - 4 A

Breaking capacity: 40 kA

Agency information

Comply with IEC 60282-1.

Time-current curves and cut-off curves

See list page 117 and data on USB at the back of the catalogue.

Features and benefits

- Cool running, low watts loss and power dissipation thanks to the M-effect ensuring high levels of substation utilisation.
- Silver elements ensuring high conductivity and low power (revenue) loss.
- 100% X-ray, all our medium voltage fuse links are X-rayed ensuring the highest possible standards are maintained.

Typical applications

- Protection of auxiliary transformers.

Part numbers and technical data

Part numbers	Current I_n (A)	Breaking capacity I_b (kA)	Cold resistance mΩ	Joule integral (I^2t)		Length mm	Diameter mm	Weight kg
				Minimum Pre-arcing	Maximum operating			
36CAV2	2	40	3.12	6.2×10^0	1.8×10^1	440	41.3	1.2
36CAV4	4	40	1.12	4.8×10^1	1.4×10^2	440	41.3	1.2

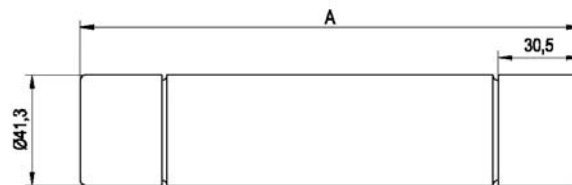

Dimensions - mm

Fuse link reference	A (mm)
CAV	440

38 kV - Voltage and auxiliary transformer type CAV Fuse links

Specifications

Description

Voltage transformer fuse links, suitable for the protection of auxiliary transformers.

Ratings

Rated Voltage: 38 kV

Current: 0.5 - 4 A

Breaking capacity: 40 kA

Agency information

Comply with IEC 60282-1.

Time-current curves and cut-off curves

See list page 117 and data on USB at the back of the catalogue.

Features and benefits

- Cool running, low watts loss and power dissipation thanks to the M-effect ensuring high levels of substation utilisation.
- Silver elements ensuring high conductivity and low power (revenue) loss.
- 100% X-ray, all our medium voltage fuse links are X-rayed ensuring the highest possible standards are maintained.

Typical applications

- Protection of auxiliary transformers.

Part numbers and technical data

Part numbers	Current I_n (A)	Breaking capacity I_b (kA)	Cold resistance m Ω	Joule integral (I ² t)		Length mm	Diameter mm	Weight kg
				Minimum pre-arcing	Maximum operating			
38CAV4E	4	40	2.42	1.2×10^1	3.4×10^1	440	41.3	1.2
38CAVH0.5E	0.5	40	66.6	1.4×10^1	9×10^1	440	41.3	1.2
38CAVH1E	1	40	66.6	1.4×10^1	9×10^1	440	41.3	1.2
38CAVH2E	2	40	2.2	1.8×10^1	1.1×10^2	440	41.3	1.2

CAV fuse links are suitable for indoor use in air only.

Type CAVH fuse links are fitted with striker pins which may be used for indication purposes.

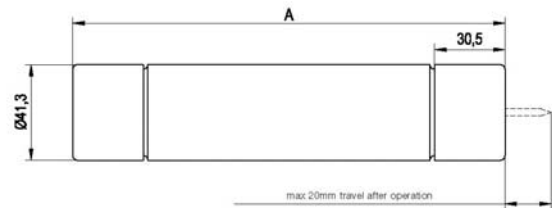

Shown with striker fitted.

Dimensions - mm

Fuse link reference	A (mm)
CAV and CAVH	440

Medium voltage oil fuse links



Introduction to current limiting fuse links for use in oil switchgear	55
British standard	
3.6 kV	56
7.2 kV	57
12 kV	58
15.5 kV	59
17.5 kV	60
24 kV	61

Introduction to current limiting fuse links for use in oil switchgear

- Fuse Links comply with IEC 60282-1, BS 2692-1 and ESI standard 12-8.
- 7.2 and 12 kV Fuse links tested at highest system voltage and approved by the UK Electricity Association approvals panel.
- Voltage ranges from 3.6 to 24 kV.
- Fitted with powerful pyrotechnic striker pin.



Bussmann under oil fuse links

Bussmann range of oil tight fuse links are designed for use in oil filled switchgear. This type was pioneered in the UK. Bussmann range has been in continuous manufacture for almost 40 years, being by far the most widely used device of its kind in the world. Over 1,000,000 Bussmann branded fuse links have been put into service without a single reported case of oil ingress. A unique triple seal system ensures against long term seal deterioration. Low power dissipation ensures long running in oil filled switchgear.

Application

Oil medium voltage fuse links are suitable for primary side transformer protection and oil filled switch combination unit.

The range is not suitable for use inside oil filled transformer tanks where high oil temperatures may be expected.

Application procedure

For any transformer the fuse current rating is determined by magnitude and duration of inrush current.

General Guide to the Selection of Oil Tight Fuse Links for Use in Primary Circuit of Three Phase Transformers.

Selection of these fuse links has been based on a compromise between the following:

1 - Withstand against magnetising inrush current is taken as 12 times full-load current for 0.1 second.

2 - Withstand against 150% permissible overload current. Recommendations marked with the following:

* Limited to permissible overload of 130%

** Permits use of a 12 kV OHFMA 80A fuse link with a 1000 kVA transformer where permissible overload does not exceed 130%.

3 - For 6.6 kV systems, 12 kV fuse links are recommended where possible in the interests of standardisation.

4 - Wherever possible, 254mm long fuse links are offered rather than equivalent 359mm types

5 - The above recommendations are not generally applicable to transformers feeding motor circuits with starting currents in excess of the transformer full load current. In this event please consult Bussmann application engineers: buletechnical@eaton.com.

General guide to the selection of oil tight fuse links for use in primary circuit of three phase transformers

Transformer kVA	Transformer priority voltage												
	3.3 kV			6.6 kV			11 kV			13.8 kV			
	Product code	Current (A)	Voltage kV	Product code	Current (A)	Voltage kV	ESI 12-8 Ref	Product code	Current (A)	Voltage kV	Product code	Current (A)	Voltage kV
200	OEFMA	63	3.6	OEFMA	31.5	12	01	OEFMA	25	12	OEFMA	16	15.5
250	OEFMA	80	3.6	OEFMA	40	12	-	OEFMA	25	12	OEFMA	20	15.5
300/315	OEFMA	100	3.6	OEFMA	50	12	02	OEFMA	31.5	12	OEFMA	25	15.5
400	OEFMA	125	3.6	OEFMA	63	12	-	OEFMA	40	12	OEFMA	31.5	15.5
500	OEFMA	160	3.6	OEFMA	71	12	03	OEFMA	50	12	OEFMA	40	15.5
630	OEFMA	200	3.6	OEFMA	100	7.2	-	OHFMA	63	12	OEFMA	50	15.5
750/800	OLGMA	250	3.6	OHGMA	125	7.2	04	OHFMA	80	12	OEFMA	63	15.5
1000	OLGMA	250*	3.6	OHGMA	140	7.2	05	OGFMA	90**	12	OHGMA	71	15.5
1250	-	-	-	OHGMA	160*	7.2	-	OGFMA	100	12	OHGMA	90	15.5
1600	-	-	-	-	-	-	-	OLGMA	125*	12	OLGMA	100*	15.5

3.6 kV - British standard oil tight fuse links

Specifications

Description

Oil tight fuse links suitable for the protection of primary side transformer and oil filled fuse switch combination unit.

Ratings

Voltage: 3.6 kV

Current: 6.3 - 250 A

Breaking capacity: 50 kA

Agency information

Comply with IEC 60282-1, BS 2692-1 and ESI standard 12-8.

Time-current curves and cut-off curves

See list page 118 and data on USB at the back of the catalogue.

Features and benefits

- Cool running, low watts loss and power dissipation thanks to the M-effect ensuring high levels of substation utilisation.
- Silver elements ensuring high conductivity and low power (revenue) loss.
- 100% X-ray, all our medium voltage fuse links are X-rayed ensuring the highest possible standards are maintained.

Typical applications

- Primary side transformer protection.
- Oil filled fuse switch combination unit.

The range is not suitable for use inside oil filled transformer tanks where high oil temperatures may be expected.

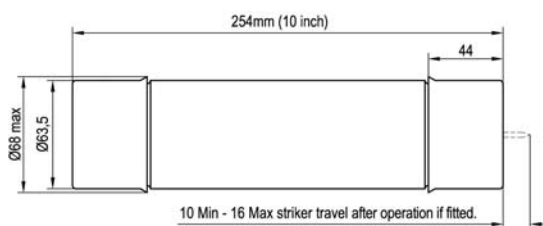

Part numbers and technical data

Part numbers	Current I_n (A)	Breaking capacity I_b (kA)	Cold resistance mΩ	Joule integral (I ² t)		Dimensional Reference BS 2692	Length mm	Diameter mm	Weight kg
				Minimum Pre-arcing	Maximum operating				
3.60EFMA6.3	6.3	50	207	2×10^1	4.9×10^2	F01	254	63.5	1.9
3.60EFMA10	10	50	83.6	1.4×10^2	1.4×10^3	F01	254	63.5	1.9
3.60EFMA16	16	50	42.5	1.7×10^2	2.4×10^3	F01	254	63.5	1.9
3.60EFMA20	20	50	33.9	2.7×10^2	3.6×10^3	F01	254	63.5	1.9
3.60EFMA25	25	50	26.5	4.5×10^2	4.8×10^3	F01	254	63.5	1.9
3.60EFMA31.5	31.5	50	17.6	1×10^3	8.8×10^3	F01	254	63.5	1.9
3.60EFMA40	40	50	15.4	8.9×10^3	1×10^4	F01	254	63.5	1.9
3.60EFMA50	50	50	11.5	1.6×10^3	1.4×10^4	F01	254	63.5	1.9
3.60EFMA63	63	50	7.60	3.3×10^3	2.4×10^4	F01	254	63.5	1.9
3.60EFMA80	80	50	63	5.2×10^3	3.4×10^4	F01	254	63.5	1.9
3.60EFMA100	100	50	42	1.2×10^4	6.2×10^4	F01	254	63.5	1.9
3.60EFMA125	125	50	32	2.1×10^4	9.6×10^4	F01	254	63.5	1.9
3.60EFMA160	160	50	2.21	1.5×10^4	1.6×10^5	F01	254	63.5	1.9
3.60EFMA200	200	50	1.74	2.4×10^4	2.3×10^5	F01	254	63.5	1.9
3.60EGMA63	6.3	50	11	3.2×10^3	1.9×10^4	F02	254	63.5	2.6
3.60EGMA80	80	50	8.70	5.2×10^3	2.7×10^4	F02	254	63.5	2.6
3.60EGMA100	100	50	5.5	5×10^3	4.9×10^4	F02	254	63.5	2.6
3.60EGMA125	125	50	4.59	7.2×10^3	6.4×10^4	F02	254	63.5	2.6
3.60EGMA160	160	50	3.44	1.3×10^4	1×10^5	F02	254	63.5	2.6
3.60EGMA200	200	50	2.29	2.9×10^4	1.8×10^5	F02	254	63.5	2.6
3.60LGMA250	250	50	1.72	5.1×10^4	2.7×10^5	F02	254	63.5	2.6

7.2 kV - British standard oil tight fuse links

Specifications

Description

Oil tight fuse links suitable for the protection of primary side transformer and oil filled fuse switch combination unit.

Ratings

Voltage: 7.2 kV

Current: 80 - 160 A

Breaking capacity: 45 kA

Agency information

Comply with IEC 60282-1, BS 2692-1 and ESI standard 12-8.

Time-current curves and cut-off curves

See list page 118 and data on USB at the back of the catalogue.

Features and benefits

- Cool running, low watts loss and power dissipation thanks to the M-effect ensuring high levels of substation utilisation.
- Silver elements ensuring high conductivity and low power (revenue) loss.
- 100% X-ray, all our medium voltage fuse links are X-rayed ensuring the highest possible standards are maintained.

Typical applications

- Primary side transformer protection.
- Oil filled fuse switch combination unit.

The range is not suitable for use inside oil filled transformer tanks where high oil temperatures may be expected.

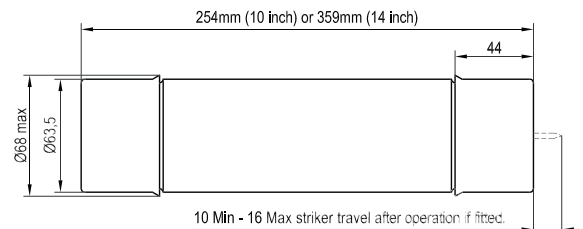

Part numbers and technical data

Part numbers	Current I_n (A)	Breaking capacity I_b (kA)	Cold resistance mΩ	Joule integral (I ² t)		Dimensional reference BS 2692	Length mm	Diameter mm	Weight kg
				Minimum pre-arcing	Maximum operating				
7.2OEFMA80	80	45	8.36	3.2×10^3	5.8×10^4	F01	254	63.5	1.9
7.2OEFMA100	100	45	5.59	6.3×10^3	9×10^4	F01	254	63.5	1.9
7.2OEFMA112	112	45	4.57	9.1×10^3	1.3×10^5	F01	254	63.5	1.9
7.2OHGMA100	100	45	69	5×10^3	7.5×10^4	F02	359	63.5	2.6
7.2OHGMA125	125	45	58	7.2×10^2	9.6×10^4	F02	359	63.5	2.6
7.2OHGMA140	140	45	4.35	9.8×10^3	1.4×10^5	F02	359	63.5	2.6
7.2OHGMA160	160	45	3.81	1.3×10^4	1.8×10^5	F02	359	63.5	2.6

12 kV - British standard oil tight fuse links

Specifications

Description

Oil tight fuse links suitable for the protection of primary side transformer and oil filled fuse switch combination unit.



Ratings

Voltage: 12 kV

Current: 6.3 - 125 A

Breaking capacity: 40 - 45 kA

Agency information

Comply with IEC 60282-1, BS 2692-1 and ESI standard 12-8.

Time-current curves and cut-off curves

See list page 118 and data on USB at the back of the catalogue.

Features and benefits

- Cool running, low watts loss and power dissipation thanks to the M-effect ensuring high levels of substation utilisation.
- Silver elements ensuring high conductivity and low power (revenue) loss.
- 100% X-ray, all our medium voltage fuse links are X-rayed ensuring the highest possible standards are maintained.

Typical applications

- Primary side transformer protection.
- Oil filled fuse switch combination unit.

The range is not suitable for use inside oil filled transformer tanks where high oil temperatures may be expected.

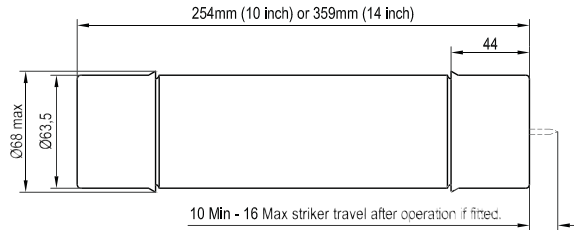

Part numbers and technical data

Part numbers	Current I_n (A)	Breaking capacity I_b (kA)	Cold resistance mΩ	Joule integral (I ² t)		Dimensional reference BS 2692	Length mm	Diameter mm	Weight kg
				Minimum pre-arcing	Maximum operating				
12OEFMA6.3	6.3	40	520	2×10^1	6.1×10^2	F01	254	63.5	1.9
12OEFMA10	10	40	214	1.4×10^2	1.8×10^3	F01	254	63.5	1.9
12OEFMA16	16	40	108	1.7×10^2	3×10^3	F01	254	63.5	1.9
12OEFMA20	20	40	77	3.4×10^2	5×10^3	F01	254	63.5	1.9
12OEFMA25	25	40	57.8	4×10^2	6.5×10^3	F01	254	63.5	1.9
12OEFMA31.5	31.5	40	38.5	8.9×10^2	1.2×10^4	F01	254	63.5	1.9
12OEFMA40	40	40	28.2	1.5×10^3	1.8×10^4	F01	254	63.5	1.9
12OEFMA50	50	40	20.1	2.9×10^3	2.8×10^4	F01	254	63.5	1.9
12OEFMA63	63	40	15.1	5.1×10^3	4.3×10^4	F01	254	63.5	1.9
12OHFMA71	71	45	12.3	3.2×10^3	5.4×10^4	F01	254	63.5	1.9
12OHFMA80	80	45	10.9	4.1×10^3	7×10^4	F01	254	63.5	1.9
12OHGMA6.3	6.3	40	520	2×10^1	6.1×10^2	F02	359	63.5	2.6
12OHGMA10	10	40	214	1.4×10^2	1.8×10^3	F02	359	63.5	2.6
12OHGMA16	16	40	108	1.7×10^2	3×10^3	F02	359	63.5	2.6
12OHGMA20	20	40	77	3.4×10^2	5×10^3	F02	359	63.5	2.6
12OHGMA25	25	40	57.8	4×10^2	6.5×10^3	F02	359	63.5	2.6
12OHGMA31.5	31.5	40	38.5	8.9×10^2	1.2×10^4	F02	359	63.5	2.6
12OHGMA40	40	40	28.2	1.5×10^3	1.8×10^4	F02	359	63.5	2.6
12OHGMA50	50	40	22.6	2.3×10^3	2.4×10^4	F02	359	63.5	2.6
12OHGMA63	63	40	17	4.1×10^3	3.7×10^4	F02	359	63.5	2.6
12OHGMA71	71	40	16.6	2×10^3	3.9×10^4	F02	359	63.5	2.6
12OHGMA80	80	40	13.4	3.2×10^3	5.5×10^4	F02	359	63.5	2.6
12OHGMA90	90	40	12.2	3.8×10^3	6.2×10^4	F02	359	63.5	2.6
12OHGMA100	100	40	8.75	6.3×10^3	8.9×10^4	F02	359	63.5	2.6
12OLGMA125	125	40	79	1×10^4	1.7×10^5	F02	359	63.5	2.6

15.5 kV - British standard oil tight fuse links

Specifications

Description

Oil tight fuse links suitable for the protection of primary side transformer and oil filled fuse switch combination unit.

Ratings

Voltage: 15.5 kV

Current: 6.3 - 100 A

Breaking capacity: 40 kA

Agency information

Comply with IEC 60282-1, BS 2692-1 and ESI standard 12-8.

Time-current curves and cut-off curves

See list page 118 and data on USB at the back of the catalogue.

Features and benefits

- Cool running, low watts loss and power dissipation thanks to the M-effect ensuring high levels of substation utilisation.
- Silver elements ensuring high conductivity and low power (revenue) loss.
- 100% X-ray, all our medium voltage fuse links are X-rayed ensuring the highest possible standards are maintained.

Typical applications

- Primary side transformer protection.
- Oil filled fuse switch combination unit.

The range is not suitable for use inside oil filled transformer tanks where high oil temperatures may be expected.

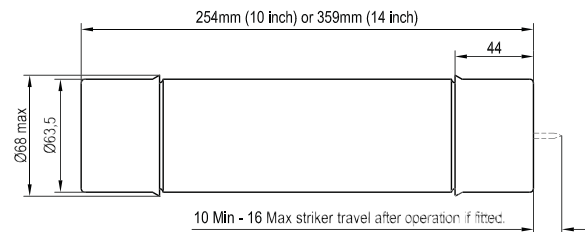

Part numbers and technical data

Part numbers	Current I_n (A)	Breaking capacity I_b (kA)	Cold resistance mΩ	Joule integral (I^2t)		Dimensional reference BS 2692	Length mm	Diameter mm	Weight kg
				Minimum pre-arcing	Maximum operating				
15.50EFMA6.3	6.3	40	392	4.8×10^1	1×10^3	F01	254	63.5	1.9
15.50EFMA10	10	40	188	4×10^1	3.4×10^3	F01	254	63.5	1.9
15.50EFMA16	16	40	101	2.7×10^1	3.4×10^3	F01	254	63.5	1.9
15.50EFMA20	20	40	78.7	4.5×10^1	4.9×10^3	F01	254	63.5	1.9
15.50EFMA25	25	40	55.3	5.2×10^1	1.1×10^4	F01	254	63.5	1.9
15.50EFMA31.5	31.5	40	36.9	1.2×10^2	1.5×10^4	F01	254	63.5	1.9
15.50EFMA40	40	40	29.5	1.8×10^2	1.5×10^4	F01	254	63.5	1.9
15.50EFMA50	50	40	22.1	3.3×10^2	3×10^4	F01	254	63.5	1.9
15.50EFMA63	63	40	17.8	2×10^2	3.9×10^4	F01	254	63.5	1.9
15.50HGMA71	71	40	17.7	2.5×10^2	4.4×10^4	F02	359	63.5	2.6
15.50HGMA80	80	40	15.5	3.2×10^2	5.4×10^4	F02	359	63.5	2.6
15.50HGMA16	90	40	11.6	5×10^2	7.5×10^4	F02	359	63.5	2.6
15.50LGMA100	100	40	10	7.2×10^2	9.6×10^4	F02	359	63.5	2.6

17.5 kV - British standard oil tight fuse links

Specifications

Description

Oil tight fuse links suitable for the protection of primary side transformer and oil filled fuse switch combination unit.

Ratings

Voltage: 17.5 kV

Current: 6.3 - 80 A

Breaking capacity: 35 kA

Agency information

Comply with IEC 60282-1, BS 2692-1 and ESI standard 12-8.

Time-current curves and cut-off curves

See list page 118 and data on USB at the back of the catalogue.

Features and benefits

- Cool running, low watts loss and power dissipation thanks to the M-effect ensuring high levels of substation utilisation.
- Silver elements ensuring high conductivity and low power (revenue) loss.
- 100% X-ray, all our medium voltage fuse links are X-rayed ensuring the highest possible standards are maintained.

Typical applications

- Primary side transformer protection.
- Oil filled fuse switch combination unit.

The range is not suitable for use inside oil filled transformer tanks where high oil temperatures may be expected.

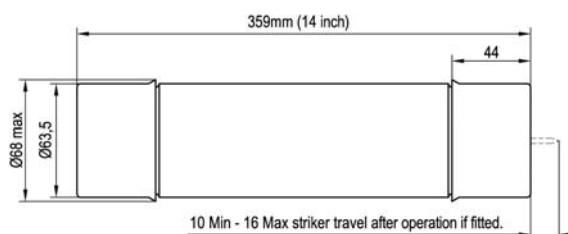

Part numbers and technical data

Part numbers	Current I_n (A)	Breaking capacity I_b (kA)	Cold resistance $m\Omega$	Joule integral (I^2t)		Dimensional reference BS 2692	Length mm	Diameter mm	Weight kg
				Minimum pre-arcing	Maximum operating				
17.50HGMA6.3	6.3	35	665	2×10^1	6.1×10^2	F02	359	63.5	2.6
17.50HGMA10	10	35	282	1.4×10^2	1.8×10^3	F02	359	63.5	2.6
17.50HGMA16	16	35	139	1.7×10^2	3×10^3	F02	359	63.5	2.6
17.50HGMA20	20	35	100	3.4×10^2	5×10^3	F02	359	63.5	2.6
17.50HGMA25	25	35	74.7	4×10^2	6.5×10^3	F02	359	63.5	2.6
17.50HGMA31.5	31.5	35	49.8	9×10^2	1.2×10^4	F02	359	63.5	2.6
17.50HGMA40	40	35	36.5	1.5×10^3	1.9×10^4	F02	359	63.5	2.6
17.50HGMA50	50	35	26	2.9×10^3	2.9×10^4	F02	359	63.5	2.6
17.50HGMA63	63	35	19.5	5.2×10^3	4.5×10^4	F02	359	63.5	2.6
17.50HGMA80	80	35	15.5	3.8×10^3	5.7×10^4	F02	359	63.5	2.6

24 kV - British standard oil tight fuse links

Specifications

Description

Oil tight fuse links suitable for the protection of primary side transformer and oil filled fuse switch combination unit.

Ratings

Voltage: 24 kV

Current: 6.3 - 50 A

Breaking capacity: 25 kA

Agency information

Comply with IEC 60282-1, BS 2692-1 and ESI standard 12-8.

Time-current curves and cut-off curves

See list page 118 and data on USB at the back of the catalogue.

Features and benefits

- Cool running, low watts loss and power dissipation thanks to the M-effect ensuring high levels of substation utilisation.
- Silver elements ensuring high conductivity and low power (revenue) loss.
- 100% X-ray, all our medium voltage fuse links are X-rayed ensuring the highest possible standards are maintained.

Typical applications

- Primary side transformer protection.
- Oil filled fuse switch combination unit.

The range is not suitable for use inside oil filled transformer tanks where high oil temperatures may be expected.

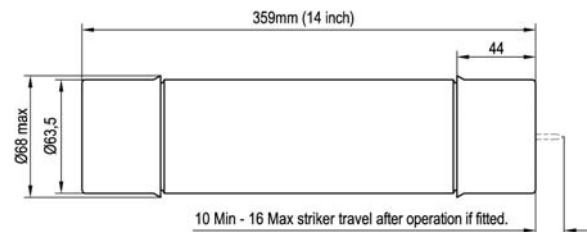

Part numbers and technical data

Part numbers	Current I_n (A)	Breaking capacity I_b (kA)	Cold resistance mΩ	Joule integral (I^2t)		Dimensional Reference BS 2692	Length mm	Diameter mm	Weight kg
				Minimum Pre-arcing	Maximum operating				
240EGMA6.3	6.3	25	605	4.8×10^1	1×10^3	F02	359	63.5	2.6
240EGMA10	10	25	290	2.5×10^2	3.4×10^3	F02	359	63.5	2.6
240EGMA16	16	25	153	2.7×10^2	3.4×10^3	F02	359	63.5	2.6
240EGMA20	20	25	119	4.4×10^2	4.9×10^3	F02	359	63.5	2.6
240EGMA25	25	25	84.5	5.2×10^2	1.1×10^4	F02	359	63.5	2.6
240EGMA31.5	31.5	25	55.9	1.2×10^3	1.5×10^4	F02	359	63.5	2.6
240EGMA40	40	25	44.7	1.8×10^3	2×10^4	F02	359	63.5	2.6
240EGMA50	50	25	34	1.2×10^3	2.4×10^4	F02	359	63.5	2.6

Medium voltage British standard air fuse links



Introduction to current limiting fuse links for use in air	63
British standard	
3.6 kV	64
7.2 kV	66
12 kV	68
15.5 kV	70
24 kV	71
36 kV	72
72.5 kV	73

Introduction to current limiting fuse links for use in air

- Medium voltage fuse links for use in air, comply with BS 2962-1 dimensions.
- Available in voltage from 3.6 kV to 72.5 kV.
- Full range performance option available at 12 kV and 24 kV.
- Wide variety of fixing arrangements available.
- Powerful pyrotechnic striker fitted.
- E-rated North American dimension products also available.
- Suitable for indoor and outdoor use.



Bussmann fuse links for use in Air

The Bussmann range of fuse links for use in air are available in British Standard form, BS 2692, Part 1 1975. A number of options are available, including Full range capability, and alternative fixing arrangements such as different types of tags, studs and collars etc. Details are available on application. Higher current ratings can be obtained by using fuse links in parallel and special fixing arrangements are available for this purpose.

Bussmann - USA Dimensions

A comprehensive range of 'E' rated North American dimension fuse links for industrial applications is also available. These are the latest technology Full range fuse links in USA Industrial Standard 2 inch and 3 inch diameter ferrule style. Extended ratings in double barrel assemblies; striker, indicator and tag versions are also available, see pages 74 to 88.

Application

Air fuse links are suitable for primary side transformer protection, fuse switch combination unit, fuse bases and fuse switches.

Selection of fuse these links has been based on a compromise between the following:

- 1 - The fuse links should withstand transformer magnetising inrush currents, taken as 12 times full load current for 0.1 seconds.
- 2 - The fuse links should discriminate with the highest rating of secondary fuse links
- 3 - The fuse links should withstand periodic overcurrents of up to 150% of transformer fuse load current
- 4 - The fuse links should operate reasonably quickly in the event of a transformer inter-turn fault or a fault in the secondary terminal zone of the transformer

Notes

a) The above recommendations are not generally applicable to transformers feeding motor circuits with starting currents in excess of the Current fuse. In this event, please consult Bussmann application engineers.

b) For 6.6 kV transformers, 12 kV fuse links are recommended, where the required current rating is available.

* Where the transformer is not subjected to periodic overcurrents, a lower fuse rating may be suitable, fuse ratings marked with "*" are only suitable for use with the transformer sizes quoted, where significant over loading does not occur.

Fuse links for use in transformers with primary voltages of 3.3, 22 and 33 kV are available, please consult Bussmann application engineers for further details buletechnical@eaton.com.

General guide to the selection of air fuse links for use in the primary circuit of three phase transformers

Transformer kVA	Transformer Priority Voltage								
	6.6 kV			11 kV			13.8 kV		
	Product code	Current (A)	Voltage (kV)	Product code	Current (A)	Voltage (kV)	Product code	Current (A)	Voltage (kV)
200	BDG	31.5	12	BDG	20	12	BDG	20	15.5
250	BDG	40	12	BDG	25	12	BDG	25	15.5
300/315	BDG	50	12	BDG	31.5	12	BDG	31.5	15.5
400	BFG	63	12	BDG	40	12	BDG	40	15.5
500	BFG	80	12	BDG	50	12	BFG	50	15.5
630	BFG	90	12	BFG	63	12	BFG	63	15.5
750/800	BFG	125	7.2	BFG	71	12	BFG	63	15.5
1000	BFG	140	7.2	BFG	90	12	BFG	85	15.5
1250	BFG	160	7.2	AKG	112	12	BFG	85*	15.5
1500	BFG	160*	7.2	AKG	125*	12	-	-	-

3.6 kV - British standard air fuse links

Specifications

Description

Air fuse links for the protection of primary side transformer. They are also used in fuse switch combination unit, fuse bases and fuse switches

Ratings

Voltage: 3.6 kV

Current: 6.3 - 100 A

Breaking capacity: 25 - 40 kA

Agency information

Comply with BS 2962-1 dimensions.

Time-current curves and cut-off curves

See list page 118 and data on USB at the back of the catalogue.

Features and benefits

- Cool running, low watts loss and power dissipation thanks to the M-effect ensuring high levels of substation utilisation.
- Silver elements ensuring high conductivity and low power (revenue) loss.
- 100% X-ray, all our medium voltage fuse links are X-rayed ensuring the highest possible standards are maintained.

Typical applications

- Primary side transformer protection.
- Used in fuse switch combination unit.
- Used in fuse bases.
- Used in fuse switches.

Dimensions - mm

Tags type	Code	A	B	C	D ϕ
A	ADGHA	359	N/A	N/A	51
C & D	ADFGC	356	314	254	51
	ADGHC	461	419	359	51
F	ADFHF	356	314	254	51
	ADGHF	461	419	359	51

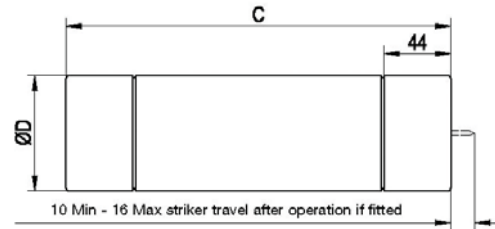

A Tags

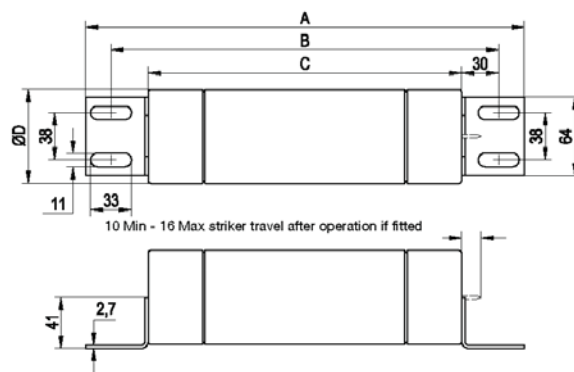

F Tags

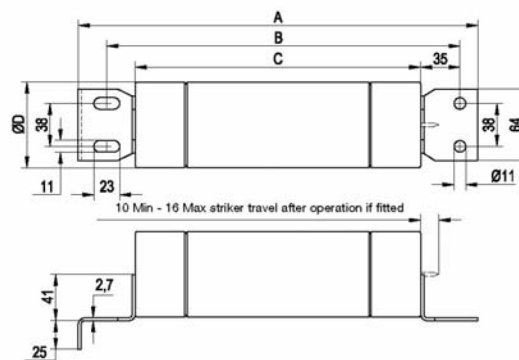

C & D Tags

Part numbers and technical data

Part numbers	Current I_n (A)	Breaking capacity I_1 (kA)	Cold resistance $m\Omega$	Joule integral (I^2t)		Length mm	Diameter mm	Weight kg
				Minimum pre-arcing	Maximum operating			
3.6ADFH*6.3	6.3	40	208	4.8×10^1	7.2×10^2	254	50.8	1.5
3.6ADFH*10	10	40	91.8	2.3×10^2	2.3×10^3	254	50.8	1.5
3.6ADFH*16	16	40	31.1	7.2×10^1	1×10^3	254	50.8	1.5
3.6ADFH*20	20	40	24.9	1.1×10^2	1.5×10^3	254	50.8	1.5
3.6ADFH*25	25	40	18.6	2×10^2	2.1×10^3	254	50.8	1.5
3.6ADFH*31.5	31.5	40	14.9	3.1×10^2	2.8×10^3	254	50.8	1.5
3.6ADFH*40	40	40	10	7.1×10^2	7.7×10^3	254	50.8	1.5
3.6ADGH*6.3	6.3	25	185	4.8×10^1	7.2×10^2	359	50.8	2.1
3.6ADGH*10	10	25	77.1	3.1×10^2	4.7×10^3	359	50.8	2.1
3.6ADGH*16	16	25	58.6	5.5×10^2	8.3×10^3	359	50.8	2.1
3.6ADGH*20	20	25	44	9.8×10^2	1.5×10^4	359	50.8	2.1
3.6ADGH*25	25	25	36.9	1.3×10^2	1.5×10^3	359	50.8	2.1
3.6ADGH*31.5	31.5	25	24.6	2.9×10^2	3.5×10^3	359	50.8	2.1
3.6ADGH*40	40	25	13.9	8×10^2	9.6×10^3	359	50.8	2.1
3.6ADGH*50	50	25	9.91	1.6×10^3	1.9×10^4	359	50.8	2.1
3.6ADGH*63	63	25	75	3.1×10^3	3.7×10^4	359	50.8	2.1
3.6ADGH*80	80	25	4.94	6.3×10^3	7.6×10^4	359	50.8	2.1
3.6ADGH*100	100	25	3.96	9.8×10^3	1.2×10^5	359	50.8	2.1

* The fifth letter or number of the part reference denotes the end fixing arrangement.

There are a wide variety of end terminations available, the most popular types, some of which have dimensional references to BS2692: Part 1, are:

- ADFHC and ADGHC: **C** Special offset tags, two hole fixings for Brush fuse switch equipment , BS Ref TA3
- ADFHF and ADGHF: **F** Offset tags two bolt fixing
- ADGHA: **A** No tags - Ferrule - BS Ref. FA3 ADIHA / BS Ref FA4 AFIHA / BS Ref FA5 - AFKHA

See previous page for outline drawings and dimensions.

Other tag variants available please consult Bussmann application engineers buletechnical@eaton.com.

7.2 kV - British standard air fuse links

Specifications

Description

Air fuse links for the protection of primary side transformer. They are also used in fuse switch combination unit, fuse bases and fuse switches

Ratings

Voltage: 7.2 kV

Current: 6.3 - 160 A

Breaking capacity: 20 - 40 kA

Agency information

Comply with BS 2962-1 dimensions.

Time-current curves and cut-off curves

See list page 118 and data on USB at the back of the catalogue.

Features and benefits

- Cool running, low watts loss and power dissipation thanks to the M-effect ensuring high levels of substation utilisation.
- Silver elements ensuring high conductivity and low power (revenue) loss.
- 100% X-ray, all our medium voltage fuse links are X-rayed ensuring the highest possible standards are maintained.

Typical applications

- Primary side transformer protection.
- Used in fuse switch combination unit.
- Used in fuse bases.
- Used in fuse switches.

Dimensions - mm

Tags type	Code	A	B	C	D ϕ
A	ADGHA	359	N/A	N/A	51
	BFGHA	359	N/A	N/A	76
C & D	ADFHC	356	314	254	51
	BDGHC	461	419	359	51
	BFGHD	461	419	359	76
F	ADFHF	356	314	254	51
	BDGHF	461	419	359	51
	AFFHF	356	314	254	76
	BFGHF	461	419	359	76

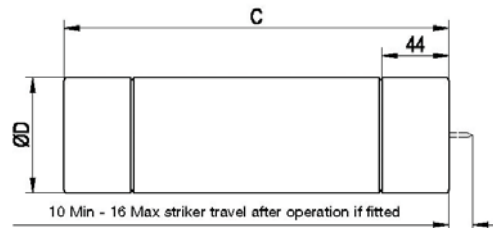

A Tags

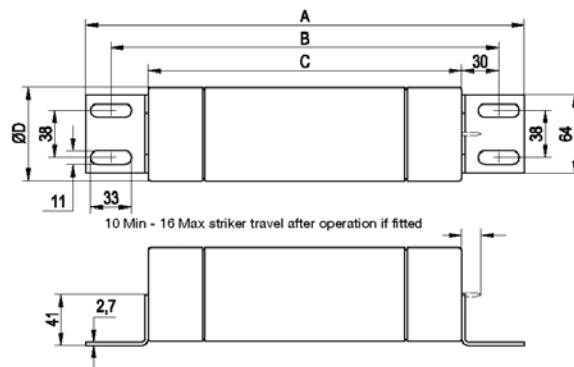

F Tags

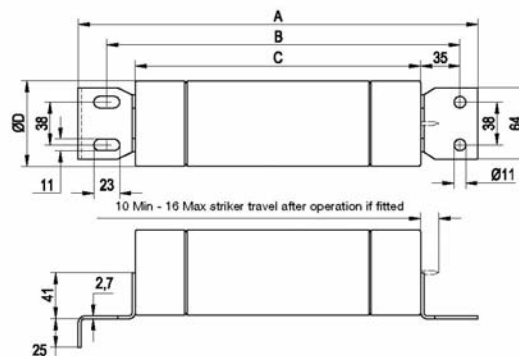

C & D Tags

Part numbers and technical data

Part numbers	Current I _n (A)	Breaking capacity I ₁ (kA)	Cold resistance mΩ	Joule integral (I ² t)		Length mm	Diameter mm	Weight kg
				Minimum pre-arcing	Maximum operating			
7.2ADFH*6.3	6.3	20	206	4.8 x 10 ¹	5.6 x 10 ²	254	50.8	1.5
7.2ADFH*10	10	20	83	7.2 x 10 ¹	9.4 x 10 ²	254	50.8	1.5
7.2ADFH*16	16	20	52.3	7.2 x 10 ¹	8.6 x 10 ²	254	50.8	1.5
7.2ADFH*20	20	20	41.8	1.1 x 10 ²	1.5 x 10 ³	254	50.8	1.5
7.2ADFH*25	25	20	31.5	2 x 10 ²	2.6 x 10 ³	254	50.8	1.5
7.2ADFH*31.5	31.5	20	22.8	3.8 x 10 ²	4.8 x 10 ³	254	50.8	1.5
7.2ADFH*40	40	20	15.6	8 x 10 ²	1.1 x 10 ⁴	254	50.8	1.5
7.2ADFH*50	50	20	11.8	1.3 x 10 ³	1.4 x 10 ⁴	254	50.8	1.5
7.2ADFH*63	63	20	8.41	2.5 x 10 ³	2.9 x 10 ⁴	254	50.8	1.5
7.2AFFH*80	80	20	5.83	6.3 x 10 ³	6.9 x 10 ⁴	254	50.8	1.5
7.2AFFH*100	100	20	4.38	9.8 x 10 ³	1.4 x 10 ⁵	254	50.8	1.5
7.2BDGH*6.3	6.3	40	206	5.1 x 10 ¹	6 x 10 ²	359	50.8	2.1
7.2BDGH*10	10	40	83	1 x 10 ²	1.3 x 10 ³	359	50.8	2.1
7.2BDGH*16	16	40	52.3	8.4 x 10 ¹	1 x 10 ³	359	50.8	2.1
7.2BDGH*20	20	40	41.8	1.1 x 10 ²	1.5 x 10 ³	359	50.8	2.1
7.2BDGH*25	25	40	31.4	2 x 10 ²	2.6 x 10 ³	359	50.8	2.1
7.2BDGH*31.5	31.5	40	22.8	4.6 x 10 ²	5.8 x 10 ³	359	50.8	2.1
7.2BDGH*40	40	40	15.7	8 x 10 ²	1.1 x 10 ⁴	359	50.8	2.1
7.2BDGH*50	50	40	11.8	1.6 x 10 ³	1.8 x 10 ⁴	359	50.8	2.1
7.2BDGH*63	63	40	7.48	3.6 x 10 ³	4.3 x 10 ⁴	359	50.8	2.1
7.2BDGH*80	80	40	5.82	6.4 x 10 ³	7 x 10 ⁴	359	50.8	2.1
7.2BFGH*90	90	40	4.72	1 x 10 ⁴	1.4 x 10 ⁵	359	76.2	4.2
7.2BFGH*100	100	40	45	1.3 x 10 ⁴	1.9 x 10 ⁵	359	76.2	4.2
7.2BFGH*125	125	40	3.15	1.6 x 10 ⁴	1.9 x 10 ⁵	359	76.2	4.2
7.2BFGH*140	140	40	2.57	2.4 x 10 ⁴	3.3 x 10 ⁵	359	76.2	4.2
7.2BFGH*160	160	40	2.35	2.9 x 10 ⁴	4 x 10 ⁵	359	76.2	4.2

* The fifth letter or number of the part reference denotes the end fixing arrangement.

There are a wide variety of end terminations available, the most popular types, some of which have dimensional references to BS2692: Part 1, are:

- **ADFH****C**: **C** Special offset tags, two hole fixings for Brush fuse switch equipment , BS Ref TA3
- **ADFH****F**: **F** Offset tags two bolt fixing
- **AFFH****D**: **D** Special offset tags, two hole fixings for Brush fuse switch equipment , BS Ref TA3
- **AFFH****F**: **F** Offset tags two bolt fixing
- **BDGH****C**: **C** Special offset tags, two hole fixings for Brush fuse switch equipment , BS Ref TA3
- **BDGH****A**: **A** No tags - Ferrule - BS Ref. FA3 ADIHA / BS Ref FA4 AFIHA / BS Ref FA5 - AFKHABDGHF
- **BFGH****A**: **A** No tags - Ferrule - BS Ref. FA3 ADIHA / BS Ref FA4 AFIHA / BS Ref FA5 - AFKHA
- **BFGH****F**: **F** Offset tags two bolt fixing

See previous page for outline drawings and dimensions.

Other tag variants available please consult Bussmann application engineers: buletechnical@eaton.com.

12 kV - British standard air fuse links

Specifications

Description

Air fuse links for the protection of primary side transformer. They are also used in fuse switch combination unit, fuse bases and fuse switches

Ratings

Voltage: 12 kV

Current: 6.3 - 125 A

Breaking capacity: 12 - 40 kA

Agency information

Comply with BS 2962-1 dimensions.

Time-current curves and cut-off curves

See list page 118 and data on USB at the back of the catalogue.

Features and benefits

- Cool running, low watts loss and power dissipation thanks to the M-effect ensuring high levels of substation utilisation.
- Silver elements ensuring high conductivity and low power (revenue) loss.
- 100% X-ray, all our medium voltage fuse links are X-rayed ensuring the highest possible standards are maintained.

Typical applications

- Primary side transformer protection.
- Used in fuse switch combination unit.
- Used in fuse bases.
- Used in fuse switches.

Dimensions - mm

Tags Type	Code	A	B	C	D ϕ
A	BDGHA	359	N/A	N/A	51
	AKGHA	359	N/A	N/A	76
	BFGHA	359	N/A	N/A	76
C & D	ADFHC	356	314	254	51
	BDGHC	461	419	359	51
	AFFHD	356	314	254	76
	AKGHD	461	419	359	76
	BFGHD	461	419	359	76
F	ADFHF	356	314	254	51
	BDGHF	461	419	359	51
	AFFHF	356	314	254	76
	AKGHF	461	419	359	76
	BFGHF	461	419	359	76

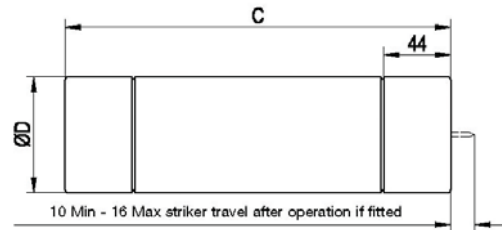

A Tags

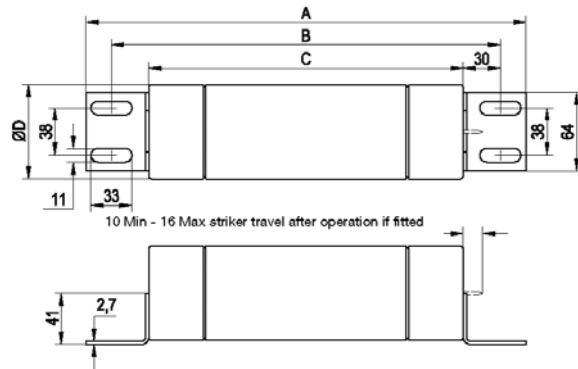

F Tags

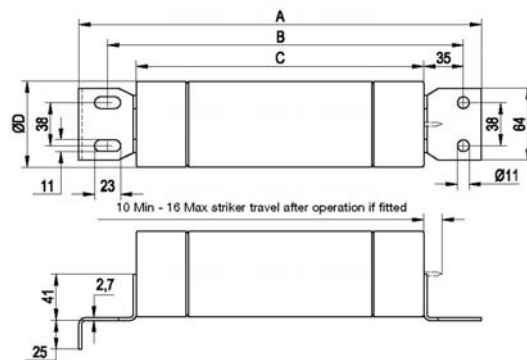

C & D Tags

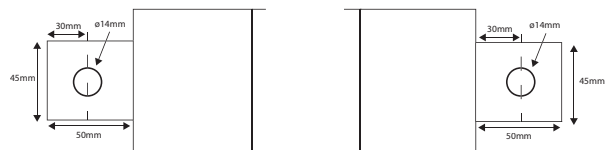

Tag 49

Part numbers and technical data

Part numbers	Current I _n (A)	Breaking capacity I _b (kA)	Cold resistance mΩ	Joule integral (I ² t)		Length mm	Diameter mm	Weight kg
				Minimum pre-arcing	Maximum operating			
12ADFH*6.3	6.3	12	356	4.8 x 10 ¹	5 x 10 ²	254	50.8	1.5
12ADFH*10	10	12	89.8	1.3 x 10 ²	2 x 10 ³	254	50.8	1.5
12ADFH*16	16	12	56.5	1.3 x 10 ²	2 x 10 ³	254	50.8	1.5
12ADFH*20	20	12	36.2	3.1 x 10 ²	3.5 x 10 ³	254	50.8	1.5
12ADFH*25	25	12	28.3	5.1 x 10 ²	6.1 x 10 ³	254	50.8	1.5
12ADFH*31*5	31.5	12	22.6	8 x 10 ²	9 x 10 ³	254	50.8	1.5
12AFFH*40	40	12	21.8	1.2 x 10 ³	1.5 x 10 ⁴	254	76.2	2.8
12AFFH*50	50	12	15.7	2 x 10 ³	2.5 x 10 ⁴	254	76.2	2.8
12AFFH*63	63	12	12.5	3.1 x 10 ³	3.9 x 10 ⁴	254	76.2	2.8
12BDGH*6.3	6.3	40	356	5.2 x 10 ¹	5 x 10 ²	359	50.8	2.1
12BDGH*10	10	40	138	6.4 x 10 ¹	1 x 10 ³	359	50.8	2.1
12BDGH*16	16	40	87	6.4 x 10 ¹	1 x 10 ³	359	50.8	2.1
12BDGH*20	20	40	63.3	1.6 x 10 ²	1.8 x 10 ³	359	50.8	2.1
12BDGH*25	25	40	43.5	3.2 x 10 ²	3.8 x 10 ³	359	50.8	2.1
12BDGH*31.5	31.5	40	32.6	5.8 x 10 ²	6.5 x 10 ³	359	50.8	2.1
12BDGH*40	40	40	21.8	1.2 x 10 ³	1.5 x 10 ⁴	359	50.8	2.1
12BDGH*45	45	40	17.5	1.8 x 10 ³	2.3 x 10 ⁴	359	50.8	2.1
12BDGH*50	50	40	14.5	2.5 x 10 ³	3.2 x 10 ⁴	359	50.8	2.1
12BFGH*56	56	40	14.6	2.9 x 10 ³	3.7 x 10 ⁴	359	76.2	4.2
12BFGH*63	63	40	12.8	3.4 x 10 ³	4.5 x 10 ⁴	359	76.2	4.2
12BFGH*71	71	40	10.6	4.6 x 10 ³	6.3 x 10 ⁴	359	76.2	4.2
12BFGH*80	80	40	9.73	6.1 x 10 ³	7.8 x 10 ⁴	359	76.2	4.2
12BFGH*90	90	40	8.37	8.1 x 10 ³	1 x 10 ⁵	359	76.2	4.2
12BFGH*100	100	40	6.88	1.1 x 10 ³	1.4 x 10 ⁵	359	76.2	4.2
12AKGH*112	112	20	5.25	1.5 x 10 ⁴	1.9 x 10 ⁵	359	76.2	4.3
12AKGH*125	125	20	4.92	2.1 x 10 ⁴	2.4 x 10 ⁵	359	76.2	4.3
Full range								
12FFGN4910	10	40	90.6	2.7 x 10 ²	4.7 x 10 ³	359	76.2	4.1
12FFGN4916	16	40	69.1	4.2 x 10 ²	6.1 x 10 ³	359	76.2	4.1
12FFGN4920	20	40	45.8	9.5 x 10 ²	1.1 x 10 ⁴	359	76.2	4.1
12FFGN4925	25	40	36.5	1.6 x 10 ³	1.5 x 10 ⁴	359	76.2	4.1
12FFGN4931.5	31.5	40	25.4	3.1 x 10 ³	2.5 x 10 ⁴	359	76.2	4.1
12FFGN4940	40	40	19.7	4.7 x 10 ³	3.8 x 10 ⁴	359	76.2	4.1
12FFGN4950	50	40	14.7	8.4 x 10 ³	5.6 x 10 ⁴	359	76.2	4.1
12FFGN4963	63	40	12.6	6.3 x 10 ³	5.4 x 10 ⁴	359	76.2	4.1

* The fifth letter or number of the part reference denotes the end fixing arrangement.

There are a wide variety of end terminations available, the most popular types, some of which have dimensional references to BS2692: Part 1, are:

- **ADFH**: **C** Special offset tags, two hole fixings for Brush fuse switch equipment , BS Ref TA3
- **ADFH**: **F** Offset tags two bolt fixing
- **AFFH**: **D** Special offset tags, two hole fixings for Brush fuse switch equipment , BS Ref TA3
- **AFFH**: **F** Offset tags two bolt fixing
- **AKGH**: **D** Special offset tags, two hole fixings for Brush fuse switch equipment , BS Ref TA3
- **AKGH**: **A** No tags - Ferrule - BS Ref. FA3 ADIHA / BS Ref FA4 AFIHA / BS Ref FA5 - AFKHA
- **AKGH**: **F** Offset tags two bolt fixing
- **BDGH**: **C** Special offset tags, two hole fixings for Brush fuse switch equipment , BS Ref TA3
- **BDGH**: **A** No tags - Ferrule - BS Ref. FA3 ADIHA / BS Ref FA4 AFIHA / BS Ref FA5 - AFKHA
- **BDGH**: **F** Offset tags two bolt fixing
- **BFGH**: **A** No tags - Ferrule - BS Ref. FA3 ADIHA / BS Ref FA4 AFIHA / BS Ref FA5 - AFKHA
- **BFGH**: **F** Offset tags two bolt fixing
- **FFGN49**: **49** Centre tags, single bolt fixing for use in Fused End Boxes

See opposite page for outline drawings and dimensions.

Other tag variants available please consult Bussmann application engineers: buletechnical@eaton.com

15.5 kV - British standard air fuse links



Specifications

Description

Air fuse links for the protection of primary side transformer. They are also used in fuse switch combination unit, fuse bases and fuse switches

Ratings

Voltage: 15.5 kV

Current: 6.3 - 85 A

Breaking capacity: 20 - 40 kA

Agency information

Comply with BS 2962-1 dimensions.

Time-current curves and cut-off curves

See list page 118 and data on USB at the back of the catalogue.

Features and benefits

- Cool running, low watts loss and power dissipation thanks to the M-effect ensuring high levels of substation utilisation.
- Silver elements ensuring high conductivity and low power (revenue) loss.
- 100% X-ray, all our medium voltage fuse links are X-rayed ensuring the highest possible standards are maintained.

Typical applications

- Primary side transformer protection.
- Used in fuse switch combination unit, fuse bases and fuse switches.

Dimensions - mm

Tags Type	Code	A	B	C	D ϕ
A	BDGHA	359	N/A	N/A	51
	BFGHA	359	N/A	N/A	76
C & D	BDGHC	461	419	359	51
	BFGHD	461	419	349	76
F	BDGHF	461	419	359	51
	BFGHF	461	419	359	76

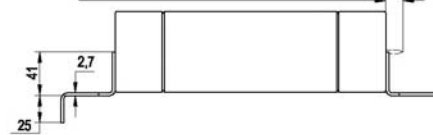
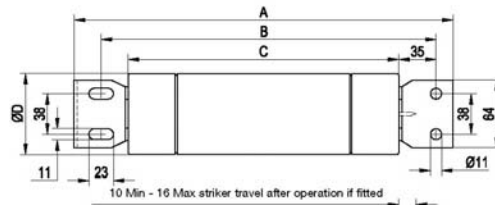
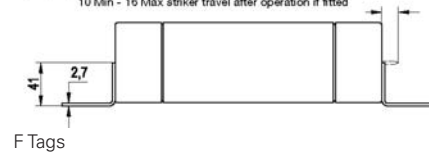
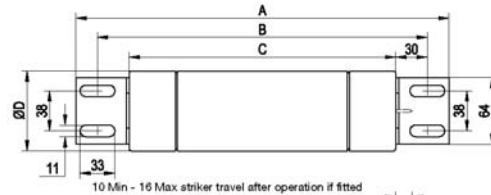
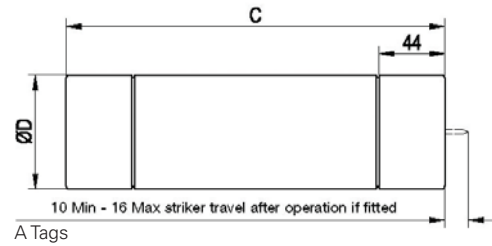

C & D Tags

Part numbers and technical data

Part numbers	Current I _n (A)	Breaking capacity I ₁ (kA)	Cold resistance m Ω	Joule integral (I ² t)		Length mm	Diameter mm	Weight kg
				Minimum pre-arcing	Maximum operating			
15.5BDGH*6.3	6.3	20	485	4.8 x 10 ¹	8.5 x 10 ²	359	50.8	2.1
15.5BDGH*10	10	20	158	7.2 x 10 ¹	1.2 x 10 ³	359	50.8	2.1
15.5BDGH*16	16	20	99.1	7.2 x 10 ¹	1.2 x 10 ³	359	50.8	2.1
15.5BDGH*20	20	20	74.6	1.3 x 10 ²	2.8 x 10 ³	359	50.8	2.1
15.5BDGH*25	25	20	54.2	2.4 x 10 ²	4.3 x 10 ³	359	50.8	2.1
15.5BDGH*31.5	31.5	20	38.2	4.9 x 10 ²	7 x 10 ³	359	50.8	2.1
15.5BDGH*40	40	20	27.2	9.6 x 10 ²	1.2 x 10 ⁴	359	50.8	2.1
15.5BFGH*50	50	20	22.2	1.6 x 10 ³	3.2 x 10 ⁴	359	76.2	4.2
15.5BFGH*63	63	20	15.5	3.2 x 10 ³	4.6 x 10 ⁴	359	76.2	4.2
15.5BFGH*80	80	20	9.73	7.2 x 10 ³	1 x 10 ⁵	359	76.2	4.2
15.5BFGH*85	85	20	9.45	7.2 x 10 ³	1 x 10 ⁵	359	76.2	4.2

* The fifth letter or number of the part reference denotes the end fixing arrangement.

There are a wide variety of end terminations available, the most popular types, some of which have dimensional references to BS2692: Part 1, are:

- BDGHC: **C** Special offset tags, two hole fixings for Brush fuse switch equipment, BS Ref TA3
- BDGHA: **A** No tags - Ferrule - BS Ref. FA3 ADIHA / BS Ref FA4 AFIHA / BS Ref FA5 - AFKHA / BDGHF: **F** Offset tags two bolt fixing
- BFGHA: **A** No tags - Ferrule - BS Ref. FA3 ADIHA / BS Ref FA4 AFIHA / BS Ref FA5 - AFKHA / BFGHF: **F** Offset tags two bolt fixing

24 kV - British standard air fuse links

Specifications

Description

Air fuse links for the protection of primary side transformer. They are also used in fuse switch combination unit, fuse bases and fuse switches

Ratings

Voltage: 24 kV

Current: 6.3 - 90 A

Breaking capacity: 12 - 35.5 kA

Agency information

Comply with BS 2962-1 dimensions.

Time-current curves and cut-off curves

See list page 118 and data on USB at the back of the catalogue.

Features and benefits

- Cool running, low watts loss and power dissipation thanks to the M-effect ensuring high levels of substation utilisation.
- Silver elements ensuring high conductivity and low power (revenue) loss.
- 100% X-ray, all our medium voltage fuse links are X-rayed ensuring the highest possible standards are maintained.

Typical applications

- Primary side transformer protection.
- Used in fuse switch combination unit, fuse bases and fuse switches.

Part numbers and technical data

Part numbers	Current I_n (A)	Breaking capacity I_b (kA)	Cold resistance mΩ	Joule integral (I^2t)		Length mm	Diameter mm	Weight kg
				Minimum pre-arcing	Maximum operating			
24ADIHA6.3	6.3	12	520	7.9×10^1	8.5×10^2	565	50.8	3
24ADIHA10	10	12	173	7.2×10^1	1.1×10^2	565	50.8	3
24ADIHA16	16	12	129	1.3×10^2	1.7×10^3	565	50.8	3
24ADIHA20	20	12	104	2×10^2	2.8×10^3	565	50.8	3
24ADIHA25	25	12	82.7	3.1×10^2	4.1×10^3	565	50.8	3
24ADIHA31.5	31.5	12	66.2	4.9×10^2	6.8×10^3	565	50.8	3
24AFIHA40	40	16	46.5	1.2×10^3	1.1×10^4	565	76.2	6.1
24AFIHA50	50	16	33.2	2.4×10^3	2.2×10^4	565	76.2	6.1
24AFIHA63	63	16	23.5	3.2×10^3	5.2×10^4	565	76.2	6.1
24AFIHA80	80	16	17.9	5.5×10^3	8.2×10^4	565	76.2	6.1
24AFIHA90	90	16	14.7	7.2×10^3	1×10^5	565	76.2	6.1
Full range								
24FDIHA3.15	3.15	35.5	893	3.1×10^1	9.8×10^1	565	50.8	3
24FDIHA5	5	35.5	412	5.9×10^1	4.5×10^2	565	50.8	3
24FDIHA6.3	6.3	35.5	412	5.9×10^1	4.5×10^2	565	50.8	3
24FDIHA10	10	35.5	205	2.7×10^2	2.1×10^3	565	50.8	3
24FDIHA16	16	35.5	103	1.1×10^3	8.3×10^3	565	50.8	3
24FDIHA20	20	35.5	88.2	1.3×10^3	4.8×10^3	565	50.8	3
24FDIHA31.5	31.5	35.5	56	5.3×10^3	2×10^4	565	50.8	3

There are a wide variety of end terminations available, the most popular types, some of which have dimensional references to BS2692: Part 1, are:

- ADIHA: **A** No tags - Ferrule - BS Ref. FA3 ADIHA / BS Ref FA4 AFIHA / BS Ref FA5 - AFKHA
- AFIHA: **A** No tags - Ferrule - BS Ref. FA3 ADIHA / BS Ref FA4 AFIHA / BS Ref FA5 - AFKHA
- FDIHA: **A** No tags - Ferrule - BS Ref. FA3 ADIHA / BS Ref FA4 AFIHA / BS Ref FA5 - AFKHA

Other tag variants available please consult Bussmann application engineers buletechnical@eaton.com

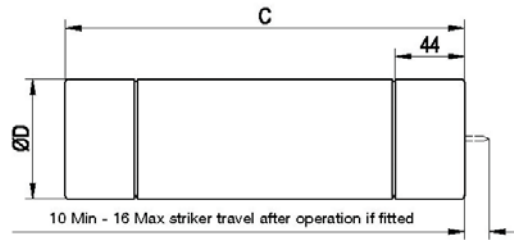

A Tags

Dimensions - mm

Tags Type	Code	A	DØ
A	ADIHA	565	51
	FDIHA	565	51
	AFIHA	565	76

36 kV - British standard air fuse links

Specifications

Description

Air fuse links for the protection of primary side transformer. They are also used in fuse switch combination unit, fuse bases and fuse switches

Ratings

Voltage: 36 kV

Current: 3.15 - 71 A

Breaking capacity: 12 - 35.5 kA

Agency information

Comply with BS 2962-1 dimensions.

Time-current curves and cut-off curves

See list page 118 and data on USB at the back of the catalogue.

Features and benefits

- Cool running, low watts loss and power dissipation thanks to the M-effect ensuring high levels of substation utilisation.
- Silver elements ensuring high conductivity and low power (revenue) loss.
- 100% X-ray, all our medium voltage fuse links are X-rayed ensuring the highest possible standards are maintained.

Typical applications

- Primary side transformer protection.
- Used in fuse switch combination unit, fuse bases and fuse switches.

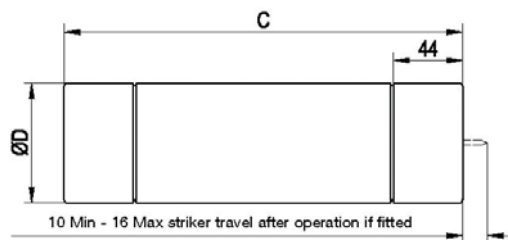

A Tags

Dimensions - mm

Tags type	Code	A	D ϕ
A	ADIHA	565	51
	AFIHA	565	76
	AFKHA	914	76

Part numbers and technical data

Part numbers	Current I _n (A)	Breaking capacity I _b (kA)	Cold resistance m Ω	Joule integral (I ² t)		Length mm	Diameter mm	Weight kg
				Minimum pre-arcing	Maximum operating			
36ADIHA3.15	3.15	16	1460	2 x 10 ¹	2.5 x 10 ²	565	50.8	3
36ADIHA5	5	16	973	4.4 x 10 ¹	5.5 x 10 ²	565	50.8	3
36ADIHA6-3	6.3	16	781	7.1 x 10 ¹	8.9 x 10 ²	565	50.8	3
36ADIHA10	10	16	378	7.2 x 10 ¹	1.1 x 10 ³	565	50.8	3
36ADIHA16	16	16	190	1.1 x 10 ²	1.7 x 10 ³	565	50.8	3
36ADIHA20	20	16	142	2 x 10 ²	2.8 x 10 ³	565	50.8	3
36ADIHA25	25	16	115	3.1 x 10 ²	4.5 x 10 ³	565	50.8	3
36ADIHA31.5	31.5	16	81.5	6.1 x 10 ²	8.1 x 10 ³	565	50.8	3
36AFIHA40	40	25	61.5	1.2 x 10 ³	1.9 x 10 ⁴	565	76.2	6.1
36AFKHA50	50	25	54.5	1.9 x 10 ³	2.8 x 10 ⁴	914	76.2	9.7
36AFKHA63	63	25	40.6	3.5 x 10 ³	5 x 10 ⁴	914	76.2	9.7
36AFKHA71	71	25	32.5	5.5 x 10 ³	8.2 x 10 ⁴	914	76.2	9.7

There are a wide variety of end terminations available, the most popular types, some of which have dimensional references to BS2692: Part 1, are:

- ADIHA: A No tags - Ferrule - BS Ref. FA3 ADIHA / BS Ref FA4 AFIHA / BS Ref FA5 - AFKHA
- AFIHA: A No tags - Ferrule - BS Ref. FA3 ADIHA / BS Ref FA4 AFIHA / BS Ref FA5 - AFKHA
- AFKHA: A No tags - Ferrule - BS Ref. FA3 ADIHA / BS Ref FA4 AFIHA / BS Ref FA5 - AFKHA

See previous page for outline drawings and dimensions.

Other tag variants available please consult Bussmann application engineers.

72.5 kV - British standard air fuse links

Specifications

Description

Air fuse links for the protection of primary side transformer. They are also used in fuse switch combination unit, fuse bases and fuse switches

Ratings

Voltage: 72.5 kV

Current: 3.15 - 40 A

Breaking capacity: 12 kA

Agency information

Comply with BS 2962-1 dimensions.

Time-current curves and cut-off curves

See list page 118 and data on USB at the back of the catalogue.

Features and benefits

- Cool running, low watts loss and power dissipation thanks to the M-effect ensuring high levels of substation utilisation.
- Silver elements ensuring high conductivity and low power (revenue) loss.
- 100% X-ray, all our medium voltage fuse links are X-rayed ensuring the highest possible standards are maintained.

Typical applications

- Primary side transformer protection.
- Used in fuse switch combination unit, fuse bases and fuse switches.

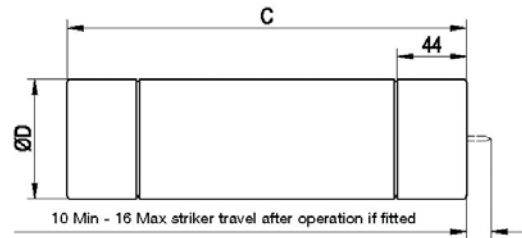

A Tags

Dimensions - mm

Tags type	Code	A	Dø
A	AFKHA	914	76

Part numbers and technical data

Part numbers	Current I _n (A)	Breaking capacity I _b (kA)	Cold resistance mΩ	Joule integral (I ² t)		Length mm	Diameter mm	Weight kg
				Minimum pre-arcing	Maximum operating			
72.5AFKHA3.15	3.15	12	4230	1.4 x 10 ¹	1.8 x 10 ²	914	76.2	9.7
72.5AFKHA5	5	12	1600	1.1 x 10 ²	1.4 x 10 ³	914	76.2	9.7
72.5AFKHA6.3	6.3	12	1200	1.9 x 10 ²	2.5 x 10 ³	914	76.2	9.7
72.5AFKHA10	10	12	519	7.2 x 10 ¹	9.3 x 10 ²	914	76.2	9.7
72.5AFKHA16	16	12	389	1.3 x 10 ²	1.7 x 10 ³	914	76.2	9.7
72.5AFKHA20	20	12	249	3.1 x 10 ²	4 x 10 ³	914	76.2	9.7
72.5AFKHA25	25	12	195	5.1 x 10 ²	6.6 x 10 ³	914	76.2	9.7
72.5AFKHA31.5	31.5	12	130	1 x 10 ³	1.3 x 10 ⁴	914	76.2	9.7
72.5AFKHA40	40	12	92.7	2 x 10 ³	2.6 x 10 ⁴	914	76.2	9.7

The fifth letter or number of the part reference denotes the end fixing arrangement.

There are a wide variety of end terminations available, the most popular types, some of which have dimensional references to BS2692: Part 1, are:

- AFKHA: A No tags - Ferrule - BS Ref. FA3 ADIHA / BS Ref FA4 AFIHA / BS Ref FA5 - AFKHA

Other tag variants available please consult Bussmann application engineers buletechnical@eaton.com

US style E-Rated medium voltage fuse links



E-Rated DIN Fuse links	
5.5 kV to 38 kV	75
E-Rated fuse links for transformers and feeder protection	
5.5 kV	77
8.25 kV	79
15.5 kV	80
E-Rated fuse links for potential and small power transformers	
JCX, JCY, JCU, JCZ and JDZ	82
JCD, JCW, JCE, JCO, JCI and JCT	84
5 - 38 kV	85
CL-14 and bolt-in	
5.5 kV	86
8.3 kV	87
15.5 kV	88
R-Rated fuse links for motor circuit protection	89

5.5 kV to 38 kV E-Rated DIN Fuse links

Specifications

Description

DIN dimensional E-Rated power fuse links with striker fitted for indoor use.



Agency

Meets E Requirements per ANSI C37.46, meets general purpose and full range requirements per ANSI C37.40.

Ratings

Voltage: 5.5 - 38 kV

Current: 10 - 450 E

IR: 25 - 65 kA

Time-current curves and cut-off curves

See list page 118 and data on USB at the back of the catalogue.

Features and benefits

- Cool running, low watts loss and power dissipation thanks to the M-effect ensuring high levels of substation utilisation.
- 100% X-ray, all our medium voltage fuse links are X-rayed ensuring the highest possible standards are maintained.

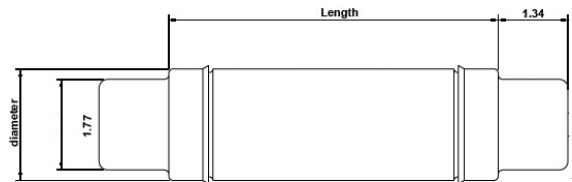

Typical applications

- Medium voltage transformer primary protection.
- Medium voltage feeder circuit protection.

Part numbers and technical data

Part numbers	Current	Interrupting capacity sym kA	Number of barrels	Length inches (mm)	Diameter inches (mm)
5.5 kV General purpose					
55GDMSJ10E	10E	65	1	17.40 (442)	2 (51)
55GDMSJ15E	15E	65	1	17.40 (442)	2 (51)
55GDMSJ20E	20E	65	1	17.40 (442)	2 (51)
55GDMSJ25E	25E	65	1	17.40 (442)	2 (51)
55GDMSJ30E	30E	65	1	17.40 (442)	2 (51)
55GDMSJ40E	40E	65	1	17.40 (442)	2 (51)
55GDMSJ50E	50E	65	1	17.40 (442)	2 (51)
55GDMSJ65E	65E	65	1	17.40 (442)	2 (51)
55GDMSJ80E	80E	65	1	17.40 (442)	2 (51)
55GDMSJ100E	100E	65	1	17.40 (442)	2 (51)
55GDMSJ125E	125E	65	1	17.40 (442)	2 (51)
55GFMSJ150E	150E	65	1	17.40 (442)	3 (76)
55GFMSJ175E	175E	65	1	17.40 (442)	3 (76)
55GFMSJ200E	200E	65	1	17.40 (442)	3 (76)
55GFMSJ250E	250E	65	1	17.40 (442)	3 (76)
55GFMSJ300E	300E	65	1	17.40 (442)	3 (76)
55GFMSJ350E	350E	65	1	17.40 (442)	3 (76)
55GFMSJ400E	400E	65	1	17.40 (442)	3 (76)
55GFMSJ450E	450E	65	1	17.40 (442)	3 (76)
15.5 kV General purpose					
155GXQJSJ175E	175E	65	1	21.14 (537)	3.5 (88)
155GXQJSJ200E	200E	65	1	21.14 (537)	3.5 (88)

5.5 kV to 38 kV E-Rated DIN Fuse links

Part numbers and technical data

Part numbers	Current	Interrupting capacity sym kA	Number of barrels	Length inches (mm)	Diameter inches (mm)
17.5 kV General purpose					
175GDMSJ10E	10E	65	1	17.40 (442)	2 (51)
175GDMSJ15E	15E	65	1	17.40 (442)	2 (51)
175GDMSJ20E	20E	65	1	17.40 (442)	2 (51)
175GDMSJ25E	25E	65	1	17.40 (442)	2 (51)
175GDMSJ30E	30E	65	1	17.40 (442)	2 (51)
175GFMSJ40E	40E	65	1	17.40 (442)	3 (76)
175GFMSJ50E	50E	65	1	17.40 (442)	3 (76)
175GFMSJ65E	65E	65	1	17.40 (442)	3 (76)
175GXMSJ80E	80E	65	1	17.40 (442)	3.5 (88)
175GXMSJ100E	100E	65	1	17.40 (442)	3.5 (88)
175GXQJSJ125E	125E	65	1	21.14 (537)	3.5 (88)
175GXQJSJ150E	150E	65	1	21.14 (537)	3.5 (88)
25.8 kV Full range					
258GDQJSJ10E	10E	25	1	21.14 (537)	2 (51)
258GDQJSJ15E	15E	25	1	21.14 (537)	2 (51)
258GDQJSJ20E	20E	25	1	21.14 (537)	2 (51)
258GDQJSJ25E	25E	25	1	21.14 (537)	2 (51)
258GDQJSJ30E	30E	25	1	21.14 (537)	2 (51)
258GXQJSJ40E	40E	25	1	21.14 (537)	3.46 (88)
258GXQJSJ50E	50E	25	1	21.14 (537)	3.46 (88)
258GXQJSJ65E	65E	25	1	21.14 (537)	3.46 (88)
258GXZSJ80E	80E	25	1	283 (712)	3.46 (88)
258GXZSJ100E	100E	25	1	283 (712)	3.46 (88)
38 kV Full range					
38GFZSJ10E	10E	25	1	283 (712)	3 (76)
38GFZSJ15E	15E	25	1	283 (712)	3 (76)
38GFZSJ20E	20E	25	1	283 (712)	3 (76)
38GFZSJ25E	25E	25	1	283 (712)	3 (76)
38GFZSJ30E	30E	25	1	283 (712)	3 (76)
38GXZSJ40E	40E	25	1	283 (712)	3.46 (88)
38GXZSJ50E	50E	25	1	283 (712)	3.46 (88)
38GXZSJ65E	65E	25	1	283 (712)	3.46 (88)

5.5 kV E-Rated fuse links for transformers and feeder protection

Specifications

Description

E-Rated power fuse links having Full range clearing capability for medium voltage transformer circuit protection.

Ratings

Voltage: 5.5 kV

Current: 5 - 450E

IR: 50 kA

Time-current curves and cut-off curves

See list page 118 and data on USB at the back of the catalogue.

Dimensions

See outline drawings below and part numbers details page 76



Features and benefits

- Cool running, low watts loss and power dissipation thanks to the M-effect ensuring high levels of substation utilisation.
- 100% X-ray, all our medium voltage fuse links are X-rayed ensuring the highest possible standards are maintained.

Typical applications

- Medium voltage transformer primary protection.
- Medium voltage feeder circuit protection.

MV055F1CAX

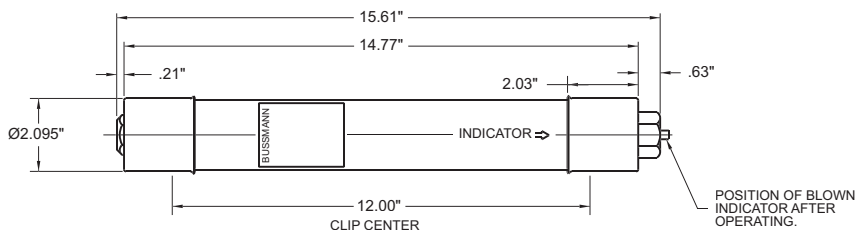

MV055F1DAX

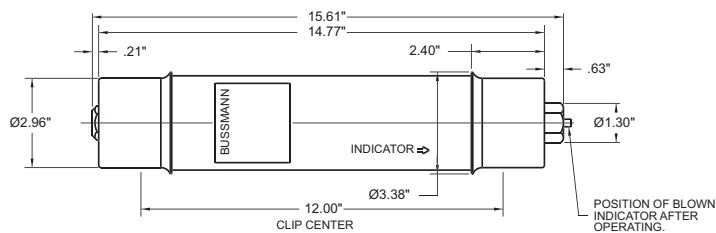

Double Barrel Dimensions

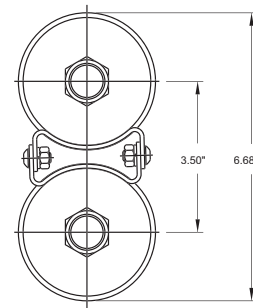

5.5 kV E-Rated fuse links for transformers and feeder protection

Part numbers and technical data

Part numbers	Current	Interrupting capacity sym kA	Number of barrels	Length inches (mm)	Diameter inches (mm)	Clip center inches (mm)
5.5FFNHA30E	30E	50	1	15.87 (403)	3 (76)	12 (304)
5.5FFNHA40E	40E	50	1	15.87 (403)	3 (76)	12 (304)
5.5FFNHA50E	50E	50	1	15.87 (403)	3 (76)	12 (304)
5.5FFNHA65E	60E	50	1	15.87 (403)	3 (76)	12 (304)
5.5FFNHA75E	75E	50	1	15.87 (403)	3 (76)	12 (304)
5.5FFNHK100E	100E	50	2	15.87 (403)	3 (76)	12 (304)
5.5FFNHK150E	150E	50	2	15.87 (403)	3 (76)	12 (304)
5.5BFNHA80*	80A	50	1	15.87 (403)	3 (76)	12 (304)
5.5BFNHA100*	100A	50	1	15.87 (403)	3 (76)	12 (304)
5.5BFNHA150*	150A	50	1	15.87 (403)	3 (76)	12 (304)
5.5BKNHA200*	200A	50	1	15.87 (403)	3 (76)	12 (304)
5.5BFNHK250*	250A	50	2	15.87 (403)	3 (76)	12 (304)
5.5BFNHK300*	300A	50	2	15.87 (403)	3 (76)	12 (304)
5.5BFNHK400*	400A	50	2	15.87 (403)	3 (76)	12 (304)
MV055F1CAX5E	5E	50	1	15.75 (400)	2 (50)	12 (304)
MV055F1CAX7E	7E	50	1	15.75 (400)	2 (50)	12 (304)
MV055F1CAX10E	10E	50	1	15.75 (400)	2 (50)	12 (304)
MV055F1CAX15E	15E	50	1	15.75 (400)	2 (50)	12 (304)
MV055F1CAX20E	20E	50	1	15.75 (400)	2 (50)	12 (304)
MV055F1CAX25E	25E	50	1	15.75 (400)	2 (50)	12 (304)
MV055F1CAX30E	30E	50	1	15.75 (400)	2 (50)	12 (304)
MV055F1CAX40E	40E	50	1	15.75 (400)	2 (50)	12 (304)
MV055F1CAX50E	50E	50	1	15.75 (400)	2 (50)	12 (304)
MV055F1CAX65E	65E	50	1	15.75 (400)	2 (50)	12 (304)
MV055F1DAX10E	10E	50	1	15.75 (400)	3 (76)	12 (304)
MV055F1DAX15E	15E	50	1	15.75 (400)	3 (76)	12 (304)
MV055F1DAX20E	20E	50	1	15.75 (400)	3 (76)	12 (304)
MV055F1DAX25E	25E	50	1	15.75 (400)	3 (76)	12 (304)
MV055F1DAX80E	80E	50	1	15.75 (400)	3 (76)	12 (304)
MV055F1DAX125E	125E	50	1	15.75 (400)	3 (76)	12 (304)
MV055F1DAX175E	175E	50	1	15.75 (400)	3 (76)	12 (304)
MV055F1DAX200E	200E	50	1	15.75 (400)	3 (76)	12 (304)
MV055F2DAX250E	250E	50	2	15.75 (400)	3 (76)	12 (304)
MV055F2DAX300E	300E	50	2	15.75 (400)	3 (76)	12 (304)
MV055F2DAX350E	350E	50	2	15.75 (400)	3 (76)	12 (304)
MV055F2DAX400E	400E	50	2	15.75 (400)	3 (76)	12 (304)
MV055F2DAX450E	450E	50	2	15.75 (400)	3 (76)	12 (304)

* These ratings are classed as Back-up fuse links

8.25 kV E-Rated fuse links for transformers and feeder protection

Specifications

Description

E-Rated power fuse links having full range clearing capability for medium voltage transformer circuit protection.



Ratings

Voltage: 8.25 kV

Current: 80 - 200A, 20 - 150E

IR: 50 kA

Time-current curves and cut-off curves

See list page 118 and data on USB at the back of the catalogue.

Features and benefits

- Cool running, low watts loss and power dissipation thanks to the M-effect ensuring high levels of substation utilisation.
- 100% X-ray, all our medium voltage fuse links are X-rayed ensuring the highest possible standards are maintained.

Typical applications

- Medium voltage transformer primary protection.
- Medium voltage feeder circuit protection.

Part numbers and technical data

Part numbers	Current	Interrupting capacity sym kA	Number of barrels	Length inches (mm)	Diameter inches (mm)	Clip center inches (mm)
8.25FFNHA20E	20E	50	1	15.87 (403)	3 (76)	12 (304)
8.25FFNHA25E	25E	50	1	15.87 (403)	3 (76)	12 (304)
8.25FFNHA30E	30E	50	1	15.87 (403)	3 (76)	12 (304)
8.25FFNHA40E	40E	50	1	15.87 (403)	3 (76)	12 (304)
8.25FFNHA50E	50E	50	1	15.87 (403)	3 (76)	12 (304)
8.25FFNHA65E	65E	50	1	15.87 (403)	3 (76)	12 (304)
8.25FFNHA75E	75E	50	1	15.87(4t03)	3 (76)	12 (304)
8.25FFNHK100E	100E	50	2	15.87 (403)	3 (76)	12 (304)
8.25FFNHK150E	150E	50	2	15.87 (403)	3 (76)	12 (304)
8.25BFNHA80*	80A	50	1	15.87 (403)	3 (76)	12 (304)
8.25BFNHA100*	100A	50	1	15.87 (403)	3 (76)	12 (304)
8.25BFNHA150*	150A	50	2	15.87 (403)	3 (76)	12 (304)
8.25BFNHA200*	200A	50	2	15.87 (403)	3 (76)	12 (304)

* These ratings are classed as back-up fuse links

15.5 kV E-Rated fuse links for transformers and feeder protection

Specifications

Description

E-Rated power fuse links having full range clearing capability for medium voltage transformer circuit protection.

Ratings

Voltage: 15.5 kV
 Current: 5 - 200E
 IR: 50 kA

Time-current curves and cut-off curves

See list page 118 and data on USB at the back of the catalogue.

Dimensions

See outline drawings below and part numbers table opposite page.



Features and benefits

- Cool running, low watts loss and power dissipation thanks to the M-effect ensuring high levels of substation utilisation.
- 100% X-ray, all our medium voltage fuse links are X-rayed ensuring the highest possible standards are maintained.

Typical applications

- Medium voltage transformer primary protection.
- Medium voltage feeder circuit protection.

MV155F1CBX

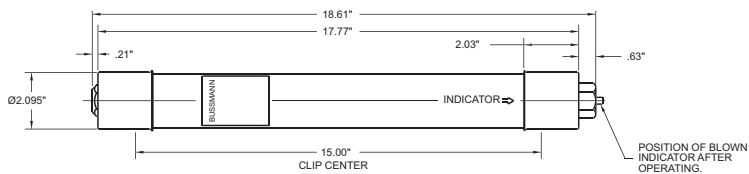

MV155F1DBX

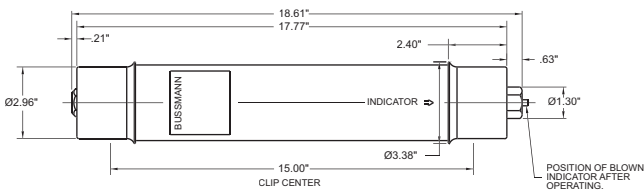

MV155F1DCX

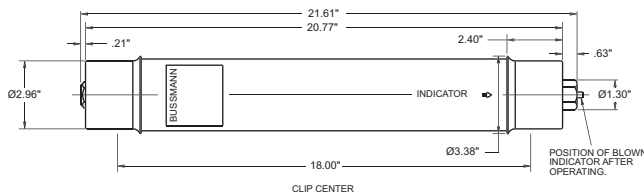

Double Barrel Dimensions

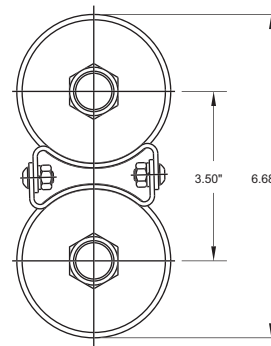

Part numbers and technical data

Part numbers	Current	Interrupting capacity sym kA	Number of barrels	Length inches (mm)	Diameter inches (mm)	Clip center inches (mm)
15.5FFVHA15E	15E	50	1	18.86 (479)	3 (76)	15
15.5FFVHA20E	20E	50	1	18.86 (479)	3 (76)	15
15.5FFVHA25E	25E	50	1	18.86 (479)	3 (76)	15
15.5FFVHA30E	30E	50	1	18.86 (479)	3 (76)	15
15.5FFVHA40E	40E	50	1	18.86 (479)	3 (76)	15
15.5FFVHA50E	50E	50	1	18.86 (479)	3 (76)	15
15.5FFVHA65E	65E	50	1	18.86 (479)	3 (76)	15
15.5FFVHA75E	75E	50	1	18.86 (479)	3 (76)	15
15.5FFVHK100E	100E	50	2	18.86 (479)	3 (76)	15
15.5FFVHK150E	150E	50	2	18.86 (479)	3 (76)	15
MV155F1CBX5E	5E	50	1	18.75 (476)	2 (50)	15
MV155F1CBX7E	7E	50	1	18.75 (476)	2 (50)	15
MV155F1CBX10E	10E	50	1	18.75 (476)	2 (50)	15
MV155F1CBX15E	15E	50	1	18.75 (476)	2 (50)	15
MV155F1CBX20E	20E	50	1	18.75 (476)	2 (50)	15
MV155F1CBX25E	25E	50	1	18.75 (476)	2 (50)	15
MV155F1CBX30E	30E	50	1	18.75 (476)	2 (50)	15
MV155F1DBX10E	10E	50	1	18.75 (476)	3 (76)	15
MV155F1DBX80E	80E	50	1	18.75 (476)	3 (76)	15
MV155F1DBX100E	100E	50	1	18.75 (476)	3 (76)	15
MV155F2DBX125E	125E	50	2	18.75 (476)	3 (76)	15
MV155F2DBX175E	175E	50	2	18.75 (476)	3 (76)	15
MV155F2DBX200E	200E	50	2	18.75 (476)	3 (76)	15
MV155F1DCX65E	65E	50	1	21.75 (552)	3 (76)	18
MV155F1DCX80E	80E	50	1	21.75 (552)	3 (76)	18
MV155F1DCX100E	100E	50	1	21.75 (552)	3 (76)	18
MV155F2DCX125E	125E	50	2	21.75 (552)	3 (76)	18
MV155F2DCX150E	150E	50	2	21.75 (552)	3 (76)	18
MV155F2DCX175E	175E	50	2	21.75 (552)	3 (76)	18
MV155F2DCX200E	200E	50	2	21.75 (552)	3 (76)	18

JCX, JCY, JCU, JCZ and JDZ E-Rated fuse links for potential and small power transformers

Specifications

Description

Indoor/enclosure E-rated medium voltage, current-limiting fuse links for potential & small power transformers with blown fuse link indication.

Ratings

Voltage: 2.4 - 8.3 kV

Current: ½ - 750A

Breaking capacity: 40 - 63 kA Sym.

Features and benefits

- Physically dimensioned for retrofitting in existing hardware.
- Open fuse indicator for ease in troubleshooting.
- Full range ANSI classification.

Typical applications

- Medium voltage transformer primary protection.
- Medium voltage feeder circuit protection.
- Medium voltage switches.
- Medium voltage metal-enclosed switchgear.



Part numbers and technical data

Part numbers	Voltage	Current	Interrupting capacity sym kA	Number of barrels	Length inches (mm)	Diameter inches (mm)
JCX-½E	2.4 kV	0.5E	40	1	9.19 (233)	2 (51)
JCX-1E	2.4 kV	1E	40	1	9.19 (233)	2 (51)
JCX-2E	2.4 kV	2E	40	1	9.19 (233)	2 (51)
JCX-3E	2.4 kV	3E	40	1	9.19 (233)	2 (51)
JCX-5E	2.4 kV	5E	40	1	9.19 (233)	2 (51)
JCX-7E	2.4 kV	7E	40	1	9.19 (233)	2 (51)
JCX-10E	2.4 kV	10E	40	1	9.19 (233)	2 (51)
JCX-15E	2.4 kV	15E	50	1	9.50 (241)	2.1 (53)
JCX-20E	2.4 kV	20E	50	1	9.50 (241)	2.1 (53)
JCX-25E	2.4 kV	25E	50	1	9.50 (241)	2.1 (53)
JCX-30E	2.4 kV	30E	50	1	10.88 (276)	3 (76)
JCX-40E	2.4 kV	40E	50	1	10.88 (276)	3 (76)
JCX-50E	2.4 kV	50E	50	1	10.88 (276)	3 (76)
JCX-65E	2.4 kV	65E	50	1	10.88 (276)	3 (76)
JCX-80E	2.4 kV	80E	50	1	10.88 (276)	3 (76)
JCX-100E	2.4 kV	100E	50	1	10.88 (276)	3 (76)
JCX-125E	2.4 kV	125E	50	1	10.88 (276)	3 (76)
JCX-150E	2.4 kV	150E	50	1	10.88 (276)	3 (76)
JCX-200E	2.4 kV	200E	50	1	10.88 (276)	3 (76)
JCX-225E	2.4 kV	225E	50	1	10.88 (276)	3 (76)
JCX-250E/280X	2.4 kV	250E	50	1	10.88 (276)	3 (76)
JCX-300E/325X	2.4 kV	300E	50	1	10.88 (276)	3 (76)
JCX-350E	2.4 kV	350E	50	1	10.88 (276)	3 (76)
JCX-400X	2.4 kV	400X	50	1	10.88 (276)	3 (76)
JCX-450X	2.4 kV	450X	50	1	10.88 (276)	3 (76)

Part numbers and technical data

Part numbers	Voltage	Current	Interrupting capacity sym kA	Number of barrels	Length inches (mm)	Diameter inches (mm)
JCY-½E	5.5 kV	0.5E	40	1	11.19 (284)	2 (51)
JCY-1E	5.5 kV	1E	40	1	11.19 (284)	2 (51)
JCY-2E	5.5 kV	2E	40	1	11.19 (284)	2 (51)
JCY-3E	5.5 kV	3E	40	1	11.19 (284)	2 (51)
JCY-5E	5.5 kV	5E	40	1	11.19 (284)	2 (51)
JCY-7E	5.5 kV	7E	40	1	11.19 (284)	2 (51)
JCY-10E	5.5 kV	10E	40	1	11.19 (284)	2 (51)
JCY-15E	5.5 kV	15E	40	1	11.19 (284)	2 (51)
JCY-20E	5.5 kV	20E	40	1	11.19 (284)	2 (51)
JCY-25E	5.5 kV	25E	40	1	11.19 (284)	2 (51)
JCU-10E	5.5 kV	10E	50	1	17.81 (452)	3 (76)
JCU-15E	5.5 kV	15E	50	1	12.87 (326)	2.1 (53)
JCU-20E	5.5 kV	20E	50	1	12.87 (326)	2.1 (53)
JCU-25E	5.5 kV	25E	50	1	12.87 (326)	2.1 (53)
JCU-30E	5.5 kV	30E	63	1	17.88 (454)	3 (76)
JCU-40E	5.5 kV	40E	63	1	17.88 (454)	3 (76)
JCU-50E	5.5 kV	50E	63	1	17.88 (454)	3 (76)
JCU-65E	5.5 kV	65E	63	1	17.88 (454)	3 (76)
JCU-80E	5.5 kV	80E	63	1	17.88 (454)	3 (76)
JCU-100E	5.5 kV	100E	63	1	17.88 (454)	3 (76)
JCU-125E	5.5 kV	125E	63	1	17.88 (454)	3 (76)
JCU-150E	5.5 kV	150E	63	1	17.88 (454)	3 (76)
JCU-175E	5.5 kV	175E	63	1	17.88 (454)	3 (76)
JCU-200E	5.5 kV	200E	63	1	17.88 (454)	3 (76)
JCU-250E	5.5 kV	250E	63	1	17.88 (454)	3 (76)
JCU-300E	5.5 kV	300E	63	1	17.88 (454)	3 (76)
JCU-350E	5.5 kV	350E	63	1	17.88 (454)	3 (76)
JCU-400E	5.5 kV	400E	63	1	17.88 (454)	3 (76)
JCU-450E	5.5 kV	450E	63	1	17.88 (454)	3 (76)
JCU-600E	5.5 kV	600E	50	1	28.81 (731)	4 (101)
JCU-750E	5.5 kV	750E	50	1	28.81 (731)	4 (101)
JCZ-15E	8.3 kV	15E	50	1	15.51 (393)	2.1 (53)
JCZ-20E	8.3 kV	20E	50	1	15.51 (393)	2.1 (53)
JCZ-25E	8.3 kV	25E	50	1	15.51 (393)	2.1 (53)
JCZ-30E	8.3 kV	30E	50	1	17.88 (454)	3 (76)
JCZ-40E	8.3 kV	40E	50	1	17.88 (454)	3 (76)
JCZ-50E	8.3 kV	50E	50	1	17.88 (454)	3 (76)
JCZ-65E	8.3 kV	65E	50	1	17.88 (454)	3 (76)
JCZ-80E	8.3 kV	80E	50	1	17.88 (454)	3 (76)
JCZ-100E	8.3 kV	100E	50	1	17.88 (454)	3 (76)
JCZ-125E	8.3 kV	125E	50	1	17.88 (454)	3 (76)
JCZ-150E	8.3 kV	150E	50	1	17.88 (454)	3 (76)
JCZ-200E	8.3 kV	200E	50	1	17.88 (454)	3 (76)
JDZ-20E	8.3 kV	20E	50	1	15.87 (403)	3 (76)
JDZ-25E	8.3 kV	25E	50	1	15.87 (403)	3 (76)
JDZ-30E	8.3 kV	30E	50	1	15.87 (403)	3 (76)
JDZ-40E	8.3 kV	40E	50	1	15.87 (403)	3 (76)
JDZ-50E	8.3 kV	50E	50	1	15.87 (403)	3 (76)
JDZ-65E	8.3 kV	65E	50	1	15.87 (403)	3 (76)
JDZ-80E	8.3 kV	80E	50	1	15.87 (403)	3 (76)
JDZ-100E	8.3 kV	100E	50	1	15.87 (403)	3 (76)
JDZ-125E	8.3 kV	125E	50	1	15.87 (403)	3 (76)

JCD, JCW, JCE, JCQ JCI, JCT E-Rated fuse links for potential and small power transformers

Specifications

Description

Indicating and non-indicating E-Rated medium voltage, current limiting fuse links for potential and small power transformers.

Ratings

Voltage: 2.4 - 15.5 kV

Current: ½ - 10A

Breaking capacity: 25 - 80 kA Sym.

Typical applications

- Primary protection of medium voltage potential transformers.



Part numbers and technical data

Part numbers	Voltage	Current	Interrupting capacity sym kA	Number of barrels	Length inches (mm)	Diameter inches (mm)
JCD-½E	2.4 kV	0.5E	63	1	4.49 (114)	0.8 (20)
JCD-1E	2.4 kV	1E	40	1	4.49 (114)	0.8 (20)
JCD-2E	2.4 kV	2E	40	1	4.49 (114)	0.8 (20)
JCD-5E	2.4 kV	5E	25	1	4.49 (114)	0.8 (20)
JCW-½E	2.4 kV/5.5 kV	0.5E	40	1	7.31 (185)	1.56 (39)
JCW-1E	2.4 kV/5.5 kV	1E	40	1	7.31 (185)	1.56 (39)
JCW-2E	2.4 kV/5.5 kV	2E	40	1	7.31 (185)	1.56 (39)
JCW-3E	2.4 kV/5.5 kV	3E	40	1	7.31 (185)	1.56 (39)
JCW-4E	2.4 kV/5.5 kV	4E	40	1	7.31 (185)	1.56 (39)
JCW-5E	2.4 kV/5.5 kV	5E	40	1	7.31 (185)	1.56 (39)
JCE-½E	5.5 kV	0.5E	50	1	5.63 (143)	0.8 (20)
JCE-1E	5.5 kV	1E	50	1	5.63 (143)	0.8 (20)
JCE-2E	5.5 kV	2E	50	1	5.63 (143)	0.8 (20)
JCE-3E	5.5 kV	3E	50	1	5.63 (143)	0.8 (20)
JCE-4E	5.5 kV	4E	50	1	5.63 (143)	0.8 (20)
JCE-5E	5.5 kV	5E	50	1	5.63 (143)	0.8 (20)
JCQ-½E	5.5 kV	0.5E	80	1	9.50 (241)	1.6 (40)
JCQ-1E	5.5 kV	1E	80	1	9.50 (241)	1.6 (40)
JCQ-1-½E	5.5 kV	1.5E	80	1	9.50 (241)	1.6 (40)
JCQ-3E	5.5 kV	3E	80	1	9.44 (239)	1.6 (40)
JCQ-5E	5.5 kV	5E	80	1	9.44 (239)	1.6 (40)
JCQ-10E	5.5 kV	10E	80	1	9.44 (239)	1.6 (40)
JCI-½E	8.3 kV	0.5E	80	1	9.50 (241)	1.6 (40)
JCI-3E	8.3 kV	3E	80	1	12.88 (327)	1.6 (40)
JCI-5E	8.3 kV	5E	80	1	12.88 (327)	1.6 (40)
JCI-10E	8.3 kV	10E	80	1	12.88 (327)	1.6 (40)
JCT-½E	15.5 kV	0.5E	80	1	12.93 (328)	1.6 (40)
JCT-1E	15.5 kV	1E	80	1	12.93 (328)	1.6 (40)
JCT-1-½E	15.5 kV	1.5E	80	1	12.93 (328)	1.6 (40)
JCT-3E	15.5 kV	3E	80	1	17.50 (444)	1.6 (40)
JCT-5E	15.5 kV	5E	80	1	17.50 (444)	1.6 (40)
JCT-10E	15.5 kV	10E	80	1	17.50 (444)	1.6 (40)

Data Sheet 6002

E-Rated fuse links for potential and small power transformers

Specifications

Description

Indicating and non-indicating E-Rated medium voltage, current-limiting fuses for potential and small power transformers.

Ratings

Voltage: 5 - 38 kV (See Part numbers table for details)

Current: 0.5 - 7E

Breaking capacity: 40 - 80 kA.

Time-current curves and cut-off curves

See list page 118 and data on USB at the back of the catalogue.

Typical applications

- Primary protection of medium voltage potential transformers.



Part numbers and technical data

Part numbers	Voltage	Current	Interrupting capacity sym kA	Number of barrels	Length inches (mm)	Diameter inches (mm)	Clipping Centres inches (mm)
5.5AMWNA0.5E	5.5 kV	0.5E	50	1	5.59 (141)	0.81 (20)	-
5.5AMWNA1E	5.5 kV	1E	50	1	5.59 (141)	0.81 (20)	-
5.5AMWNA2E	5.5 kV	2E	50	1	5.59 (141)	0.81 (20)	-
5.5AMWNA3E	5.5 kV	3E	50	1	5.59 (141)	0.81 (20)	-
5.5AMWNA4E	5.5 kV	4E	50	1	5.59 (141)	0.81 (20)	-
5.5AMWNA5E	5.5 kV	5E	50	1	5.59 (141)	0.81 (20)	-
5.5ABWNA0.5E	5.5 kV	0.5E	50	1	5.59 (141)	1 (25)	-
5.5ABWNA1E	5.5 kV	1E	50	1	5.59 (141)	1 (25)	-
5.5ABWNA2E	5.5 kV	2E	50	1	5.59 (141)	1 (25)	-
5.5ABWNA3E	5.5 kV	3E	50	1	5.59 (141)	1 (25)	-
5.5ABWNA5E	5.5 kV	5E	50	1	5.59 (141)	1 (25)	-
5.5CAV15E	5.5 kV	15E	50	1	7.36 (186)	1.63 (41)	6 (152)
5.5CAVH0.5E	5.5 kV	0.5E	50	1	7.36 (186)	1.63 (41)	6 (152)
5.5CAVH1E	5.5 kV	1E	50	1	7.36 (186)	1.63 (41)	6 (152)
5.5CAVH2E	5.5 kV	2E	50	1	7.36 (186)	1.63 (41)	6 (152)
7.2AMWNA0.5E	7.2 kV	0.5E	50	1	5.59 (141)	0.81 (20)	-
7.2AMWNA1E	7.2 kV	1E	50	1	5.59 (141)	0.81 (20)	-
7.2AMWNA2E	7.2 kV	2E	50	1	5.59 (141)	0.81 (20)	-
7.2AMWNA3E	7.2 kV	3E	50	1	5.59 (141)	0.81 (20)	-
7.2AMWNA4E	7.2 kV	4E	50	1	5.59 (141)	0.81 (20)	-
7.2AMWNA5E	7.2 kV	5E	50	1	5.59 (141)	0.81 (20)	-
15.5CAV0.5E	15.5 kV	0.5E	80	1	12.87 (326)	1.63 (41)	11.5 (292)
15.5CAV1E	15.5 kV	1E	80	1	12.87 (326)	1.63 (41)	11.5 (292)
15.5CAV2E	15.5 kV	2E	80	1	12.87 (326)	1.63 (41)	11.5 (292)
15.5CAV3E	15.5 kV	3E	80	1	12.87 (326)	1.63 (41)	11.5 (292)
15.5CAV5E	15.5 kV	5E	80	1	12.87 (326)	1.63 (41)	11.5 (292)
15.5CAV7E	15.5 kV	7E	80	1	12.87 (326)	1.63 (41)	11.5 (292)
15.5CAVH0.5E	15.5 kV	0.5E	80	1	12.87 (326)	1.63 (41)	11.5 (292)
15.5CAVH1E	15.5 kV	1E	80	1	12.87 (326)	1.63 (41)	11.5 (292)
15.5CAVH2E	15.5 kV	2E	80	1	12.87 (326)	1.63 (41)	11.5 (292)
38CAVH0.5E	38 kV	0.5E	40	1	17.32 (439)	1.63 (41)	15 (381)
38CAVH1E	38 kV	1E	40	1	17.32 (439)	1.63 (41)	15 (381)
38CAVH2E	38 kV	2E	40	1	17.32 (439)	1.63 (41)	15 (381)
38CAV4E	38 kV	4E	40	1	17.32 (439)	1.63 (41)	15 (381)

E-Rated fuse links: 5.5 kV CL-14 and bolt-in

ECL055 Specifications

Description

E-Rated medium voltage, current-limiting fuses for transformer and feeder protection.

Ratings

Voltage: 5.5 kV E-Rated

Current: 10 - 900 A

Breaking capacity: 63 kA Sym. Max.

Agency information

Meets E requirements per ANSI C37.46, meets general purpose requirements per ANSI C37.40.

Typical applications

- 5 kV Transformer primary protection.
- 5 kV Feeder circuit protection.
- 5 kV Voltage switches.
- 5 kV Metal-enclosed switchgear.

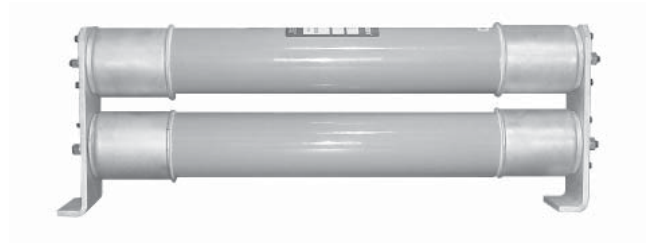

Part numbers and technical data

Part numbers	Voltage (kV)	Current (E)	Breaking capacity (Sym) kA	Number of barrels
ECL055-10E	5.5	10	63	1
ECL055-15E	5.5	15	63	1
ECL055-20E	5.5	20	63	1
ECL055-25E	5.5	25	63	1
ECL055-30E	5.5	30	63	1
ECL055-40E	5.5	40	63	1
ECL055-50E	5.5	50	63	1
ECL055-65E	5.5	65	63	1
ECL055-80E	5.5	80	63	1
ECL055-100E	5.5	100	63	1
ECL055-125E	5.5	125	63	1
ECL055-150E	5.5	150	63	1
ECL055-200E	5.5	200	63	1
ECL055-250E	5.5	250	63	1
ECL055-300E	5.5	300	63	2
ECL055-400E	5.5	400	63	2
ECL055-450E	5.5	450	63	2
ECL055-500E	5.5	500	63	2
ECL055-600E	5.5	600	63	2
ECL055-750E	5.5	750	63	3
ECL055-900E	5.5	900	63	3

Part numbers Construction (example)

Part numbers	Voltage rating	Ampere rating
ECL	055 (055 = 5.5 kV)	300E

E-Rated fuse links: 8.3 kV CL-14

ECL083 Specifications

Description

E-Rated medium voltage, current-limiting fuses for transformer and feeder protection.

Ratings

Voltage: 8.3 kV E-Rated

Current: 65 - 350 A

Breaking capacity: 50 kA

Agency information

Meets E requirements per ANSI C37.46, meets general purpose requirements per ANSI C37.40.

Typical applications

- 8.3 kV Transformer primary protection.
- 8.3 kV Feeder circuit protection.
- 8.3 kV Voltage switches.
- 8.3 kV Metal-enclosed switchgear.



Part numbers and technical data

Part numbers	Voltage (kV)	Current (E)	Breaking capacity (Sym) kA	Number of barrels
ECL083-65E	8.3	65	50	1
ECL083-80E	8.3	80	50	1
ECL083-100E	8.3	100	50	1
ECL083-125E	8.3	125	50	1
ECL083-150E	8.3	150	50	1
ECL083-175E	8.3	175	50	1
ECL083-200E	8.3	200	50	2
ECL083-250E	8.3	250	50	2
ECL083-300E	8.3	300	50	2
ECL083-350E	8.3	350	50	2

Part numbers construction (example)

Part numbers	Voltage rating	Ampere rating
ECL	083 (0.83 = 8.3 kV)	300E

E-Rated fuse links: 15.5 kV CL-14

ECL155 Specifications

Description

E-Rated medium voltage, current-limiting fuses for transformer and feeder protection.

Ratings

Voltage: 15.5 kV E-Rated

Current: 10 - 300A

Breaking capacity: 63 kA Sym. (10-200 A)
50 kA Sym. (250-300 A)



Agency information

Meets E requirements per ANSI C37.46, meets general purpose requirements per ANSI C37.40.

Typical applications

- 15 kV Transformer primary protection.
- 15 kV Feeder circuit protection.
- 15 kV Voltage switches.
- 15 kV Metal-enclosed switchgear.

Part numbers and technical data

Part numbers	Voltage (kV)	Current (E)	Breaking capacity (Sym) kA	Number of barrels
ECL155-10E	15.5	10	63	1
ECL155-15E	15.5	15	63	1
ECL155-20E	15.5	20	63	1
ECL155-25E	15.5	25	63	1
ECL155-30E	15.5	30	63	1
ECL155-40E	15.5	40	63	1
ECL155-50E	15.5	50	63	1
ECL155-65E	15.5	65	63	1
ECL155-80E	15.5	80	63	1
ECL155-100E	15.5	100	63	1
ECL155-125E	15.5	125	63	1
ECL155-150E	15.5	150	63	2
ECL155-200E	15.5	200	63	2
ECL155-250E	15.5	250	50	2
ECL155-300E	15.5	300	50	2

Part numbers construction (example)

Part numbers	Voltage rating	Ampere rating
ECL	155 (155 = 15.5 kV)	300E

R-Rated fuse links for motor circuit protection

Specifications

Description

Indoor/enclosure R-Rated medium voltage, current-limiting fuse links for motor circuit protection.

Ratings

Voltage: 2.4 - 7.2 kV

Current: 25 - 450A

Breaking capacity: 50 kA Sym

Agency information

UL recognized: 2540Vac — JCK, JCK-A, 5080Vac — JCL, JCL-A,
UL recognized (Guide #MSSS2, File #E96676).

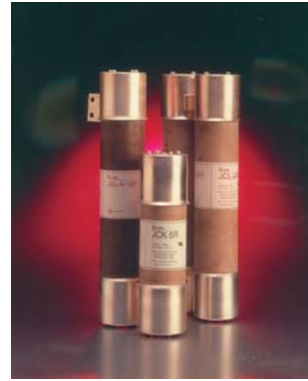

Typical applications

- Medium voltage motor controllers.

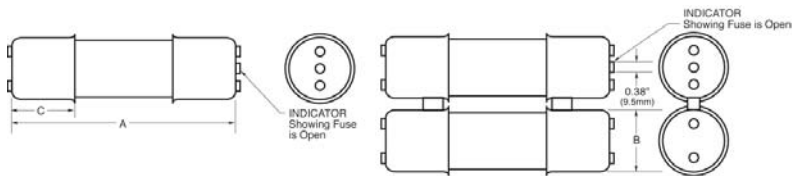

Figure 1

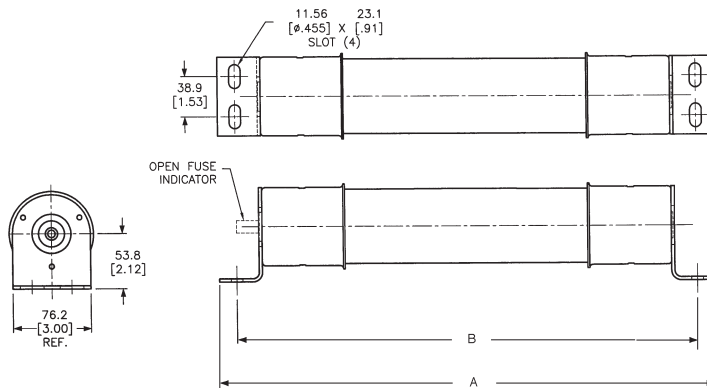

Figure 2

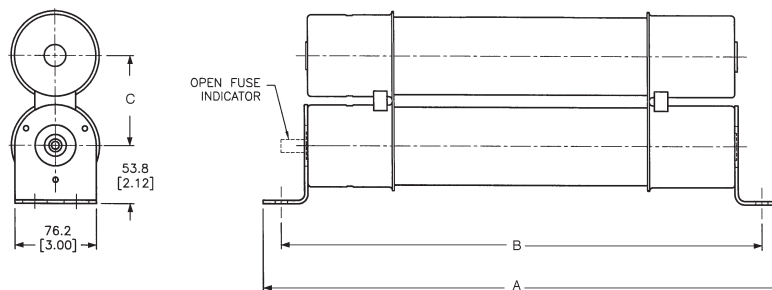

Figure 3

Data Sheet 6001

R-Rated fuse links for motor circuit protection

Part numbers and technical data

Part numbers	Current (A)	Interrupting capacity sym kA	Number of barrels	Length in (mm)	Diameter in (mm)
2400V (see figure 1 page 89)					
JCK-2R	70A	50	1	11.24 (285)	3 (76)
JCK-3R	100A	50	1	11.24 (285)	3 (76)
JCK-4R	130A	50	1	11.24 (285)	3 (76)
JCK-5R	150A	50	1	11.24 (285)	3 (76)
JCK-6R	170A	50	1	11.24 (285)	3 (76)
JCK-9R	200A	50	1	11.24 (285)	3 (76)
JCK-12R	230A	50	1	11.24 (285)	3 (76)
JCK-18R	390A	50	2	11.24 (285)	3 (76)
JCK-24R	450A	50	2	11.24 (285)	3 (76)
2400V - With Westinghouse ampguard hookeye (see figure 1 page 89)					
JCK-A-2R	70A	50	1	11.24 (285)	3 (76)
JCK-A-3R	100A	50	1	11.24 (285)	3 (76)
JCK-A-4R	130A	50	1	11.24 (285)	3 (76)
JCK-A-5R	150A	50	1	11.24 (285)	3 (76)
JCK-A-6R	170A	50	1	11.24 (285)	3 (76)
JCK-A-9R	200A	50	1	11.24 (285)	3 (76)
JCK-A-12R	230A	50	1	11.24 (285)	3 (76)
JCK-A-18R	390A	50	2	11.24 (285)	3 (76)
JCK-A-24R	450A	50	2	11.24 (285)	3 (76)
2400V - Bolt-on (see figures 2 and 3 page 89)					
JCK-B-30	25A	50	1	14.18 (360)	3 (76)
JCK-B-2R	70A	50	1	14.18 (360)	3 (76)
JCK-B-3R	100A	50	1	14.18 (360)	3 (76)
JCK-B-4R	130A	50	1	14.18 (360)	3 (76)
JCK-B-5R	150A	50	1	14.18 (360)	3 (76)
JCK-B-6R	170A	50	1	14.18 (360)	3 (76)
JCK-B-9R	200A	50	1	14.18 (360)	3 (76)
JCK-B-12R	230A	50	1	14.18 (360)	3 (76)
JCK-B-18R	390A	50	2	14.18 (360)	3 (76)
JCK-B-24R	450A	50	2	14.18 (360)	3 (76)
2400V - Hermetically sealed, for use with ampguard motor starters (see figure 1 page 89)					
JCH-30	25A	50	1	10.81 (275)	3 (76)
JCH-2R	70A	50	1	10.81 (275)	3 (76)
JCH-3R	100A	50	1	10.81 (275)	3 (76)
JCH-4R	130A	50	1	10.81 (275)	3 (76)
JCH-5R	150A	50	1	10.81 (275)	3 (76)
JCH-6R	170A	50	1	10.81 (275)	3 (76)
JCH-9R	200A	50	1	10.81 (275)	3 (76)
JCH-12R	230A	50	1	10.81 (275)	3 (76)
JCH-18R	390A	50	2	10.81 (275)	3 (76)
JCH-24R	450A	50	2	10.81 (275)	3 (76)
4800V (see figure 1 page 89)					
JCL-2R	70	50	1	15.76 (400)	3 (76)
JCL-3R	100	50	1	15.76 (400)	3 (76)
JCL-4R	130	50	1	15.76 (400)	3 (76)
JCL-5R	150	50	1	15.76 (400)	3 (76)
JCL-6R	170	50	1	15.76 (400)	3 (76)
JCL-9R	200	50	1	15.76 (400)	3 (76)
JCL-12R	230	50	1	15.76 (400)	3 (76)
JCL-18R	390	50	2	15.76 (400)	3 (76)
JCL-24R	450	50	2	15.76 (400)	3 (76)

R-Rated fuse links for motor circuit protection

Part numbers and technical data

Part numbers	Current (A)	Interrupting capacity sym kA	Number of barrels	Length in (mm)	Diameter in (mm)
4800V - With Westinghouse ampguard hookeye (see figure 1 page 89)					
JCL-A-2R	70	50	1	15.76 (400.3)	3 (76.2)
JCL-A-3R	100	50	1	15.76 (400.3)	3 (76.2)
JCL-A-4R	130	50	1	15.76 (400.3)	3 (76.2)
JCL-A-5R	150	50	1	15.76 (400.3)	3 (76.2)
JCL-A-6R	170	50	1	15.76 (400.3)	3 (76.2)
JCL-A-9R	200	50	1	15.76 (400.3)	3 (76.2)
JCL-A-12R	230	50	1	15.76 (400.3)	3 (76.2)
JCL-A-18R	390	50	2	15.76 (400.3)	3 (76.2)
JCL-A-24R	450	50	2	15.76 (400.3)	3 (76.2)
4800V - Bolt-on (see figures 2 and 3 page 89)					
JCL-B-30	30	50	1	19.25 (488.9)	3 (76.2)
JCL-B-2R	70	50	1	19.25 (488.9)	3 (76.2)
JCL-B-3R	100	50	1	19.25 (488.9)	3 (76.2)
JCL-B-4R	130	50	1	19.25 (488.9)	3 (76.2)
JCL-B-5R	150	50	1	19.25 (488.9)	3 (76.2)
JCL-B-6R	170	50	1	19.25 (488.9)	3 (76.2)
JCL-B-9R	200	50	1	19.25 (488.9)	3 (76.2)
JCL-B-12R	230	50	1	19.25 (488.9)	3 (76.2)
JCL-B-18R	390	50	2	19.25 (488.9)	3 (76.2)
JCL-B-24R	450	50	2	19.25 (488.9)	3 (76.2)
4800V - Hermetically sealed, for use with ampguard motor starters (see figure 1 page 89)					
JCG-30	30	50	1	15.91 (404.1)	3 (76.2)
JCG-2R	70	50	1	15.91 (404.1)	3 (76.2)
JCG-3R	100	50	1	15.91 (404.1)	3 (76.2)
JCG-4R	130	50	1	15.91 (404.1)	3 (76.2)
JCG-5R	150	50	1	15.91 (404.1)	3 (76.2)
JCG-6R	170	50	1	15.91 (404.1)	3 (76.2)
JCG-9R	200	50	1	15.91 (404.1)	3 (76.2)
JCG-12R	230	50	1	15.91 (404.1)	3 (76.2)
JCG-A-18R	390	50	2	15.91 (404.1)	3 (76.2)
JCG-A-24R	450	50	2	15.91 (404.1)	3 (76.2)
7200V - With ampguard hookeye (see figure 1 page 89)					
JCR-A-2R	70	50	1	15.85 (402.6)	3 (76.2)
JCR-A-3R	100	50	1	15.85 (402.6)	3 (76.2)
JCR-A-4R	130	50	1	15.85 (402.6)	3 (76.2)
JCR-A-5R	150	50	1	15.85 (402.6)	3 (76.2)
JCR-A-6R	170	50	1	15.85 (402.6)	3 (76.2)
JCR-A-9R	200	50	1	15.85 (402.6)	3 (76.2)
JCR-A-12R	230	50	1	15.85 (402.6)	3 (76.2)
JCR-A-18R	390	50	2	15.85 (402.6)	3 (76.2)
JCR-A-24R	450	50	2	15.85 (402.6)	3 (76.2)
7200V - Bolt-on (see figures 2 and 3 page 87)					
JCR-B-2R	70	50	1	19.25 (488.9)	3.31 (84.1)
JCR-B-3R	100	50	1	19.25 (488.9)	3.31 (84.1)
JCR-B-4R	130	50	1	19.25 (488.9)	3.31 (84.1)
JCR-B-5R	150	50	1	19.25 (488.9)	3.31 (84.1)
JCR-B-6R	170	50	1	19.25 (488.9)	3.31 (84.1)
JCR-B-9R	200	50	1	19.25 (488.9)	3.31 (84.1)
JCR-B-12R	230	50	1	19.25 (488.9)	3.31 (84.1)
JCR-B-18R	390	50	2	19.25 (488.9)	3.31 (84.1)
JCR-B-24R	450	50	2	19.25 (488.9)	3.31 (84.1)

Fuse clips

- VT Fuse Clips for 25.4mm diameter.
- DIN standard Clips for 'F' and 'T' range fuse links.
- BS Mounting Clips suitable for 50.8mm and 76.2mm Oil, Air, and Motor Fuse Links up to 200A.

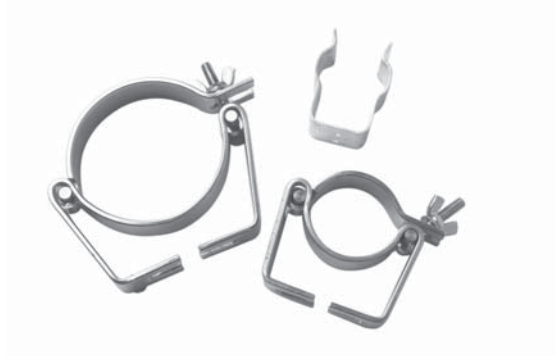

Bussmann fuse clips

To complement the range of tag fixings offered by Bussmann, a range of fuse clips are available. These are suitable for use with British Standard, DIN Dimensioned and VT ferrule style fuse links. The BS and DIN Clips are rated up to 200 Amps. They are designed to be fitted onto insulated studs or directly onto a busbar.

Fuse clips	Clip reference
DIN fuse links to 43625	270303 or A3354745
Voltage transformer and auxiliary type fuse links	A3354705
British standard fuse links	
50.8mm (2") diameter	A3354710
63.5mm (2 1/2") diameter	A3354720
76.2mm (3") diameter	A3354730

Clips for 25.4mm VT Fuse links

Material

Nickel silver alloy.

Order as part number: A3354705#

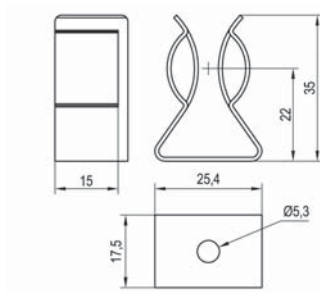

Clips for DIN Fuse links

Material

Nickel-plated copper

Order as part number: 270303

Suitable for use with Bussmann DIN fuse links. Also suitable for use with other Bussmann fuse links having type 'J' end tags, to DIN 43625, with maximum current rating of 200 Amps

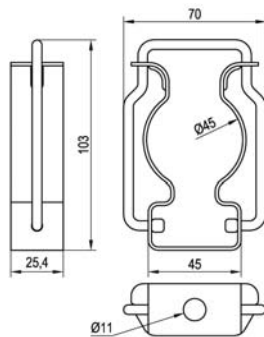

Clips for British standard and DIN Style fuse links

Material

Nickel-plated copper

Order as part numbers:

A3354745 for 45mm diameter

A3354710 for 50.8mm diameter

A3354720 for 63.5mm diameter

A3354730 for 76.2mm diameter

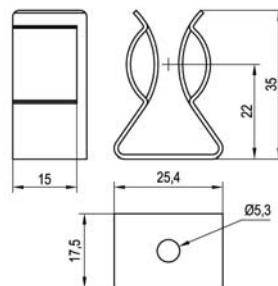

Expulsion fuse links for use in high voltage distribution cut-outs

- Wide range of options available from 15 kV to 72 kV in ANSI T & K characteristics.
- Extra rapid option also available.

Bussmann expulsion fuse links

Bussmann expulsion fuse links have been widely used throughout the world for over 40 years. They have in that time built up a formidable reputation and consistency of performance.

Bussmann expulsion fuse links are designed to be interchangeable with other types of manufacturers cut-out units and are available in several patterns.



Application

Expulsion fuse links current ratings should be selected on the basis of maximum expected transient no damage currents rather than on full load current. In addition, the selection of higher current ratings will reduce the possibility of supply interruption due to transient surges such as those due to lightning strikes (for information on our Surge Protection Device SPD, please contact buletechnical@eaton.com).

Links should be handled with a reasonable degree of care when installing. Excessively rough handling may damage the element.

It is normal, under certain fault conditions, for arc extinguishing material and/or metal particles to be expelled from the fuse assembly. It is therefore recommended that reasonable precautions be taken to prevent the installation being approached by unauthorised persons.

How to order – Parts referencing system			
Voltage (kV)	1st Letter Type of current characteristics	2nd letter Type of termination	Current (A)
15 25 46 72	<p>T = complies with ANSI C 37-42 requirements for slow acting T characteristics.</p> <p>K = complies with ANSI C 37-42 requirements for fast acting K characteristics.</p> <p>XA = this type of expulsion fuse link has an extra rapid characteristic. It is suitable for applications where a high degree of system protection is required at the expense of discrimination.</p> <p>S = Solid links rated at 100A only are also available in both button head and universal versions for fitting into expulsion fuse carriers where required. These can be ordered in a similar way using the abbreviation S, e.g. 15SB100, etc.</p>	<p>B = a fixed NEMA button head link.</p> <p>U = a universal link, with double tail and slip off NEMA button head.</p> <p>D = double tailed link without NEMA button head.</p> <p>BR = as pattern B but the button head is attached via a 1/4 UNF thread to allow use of an extension rod.</p> <p>See outline drawings opposite page for reference.</p>	<p>1 to 6, 7.5, 8, 10, 12, 15, 20, 25, 30, 40, 50, 60, 65, 75, 80, 100.</p>

Thus a typical ordering reference for a 15 kV NEMA type K, button head 30A fuse link would be 15KB30 expulsion fuse link.

The fuse link assembly for a given range is standard to all Voltages. The exception is that the tail length is varied to suit the dimensions of expulsion carrier of different ratings.

Expulsion fuse links

Specifications

Description

Expulsion fuse links available in a wide range of options from 15 kV to 72 kV in ANSIT&K characteristics.

Ratings

Voltage: 15 to 72 kV

Amps: 1 to 100 A

Breaking capacity: depends on voltage but is approximately 8 kA

Agency information

Type T: complies with ANSI C37-42

Type K: complies with ANSI C37-42

Time-current curves and cut-off curves

See list page 118 and data on USB at the back of the catalogue.

Packaging

Up to and including 50A: 25 in a carton.

From 60A to 100A: 10 in a carton.

To avoid incorrect replacement the fuse links have colour coded labels:

Pink label: Type XA.

Yellow label: Type K.

Green label: Type T.

Typical applications

- Primary side transformer protection.
- Feeder protection.
- Capacitor bank protection.

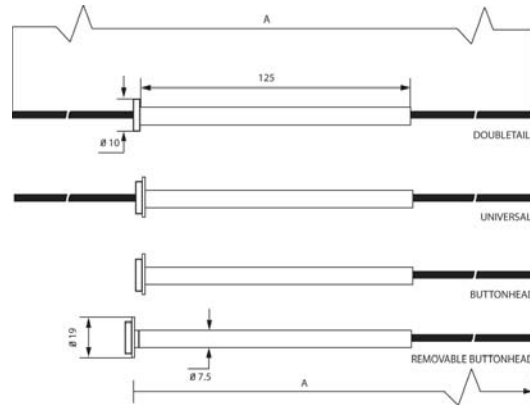

1-50A

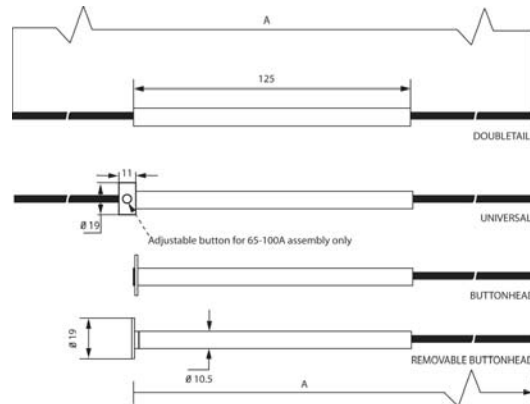

60-100A

Type	kV	A
	15 kV	533 (21")
	25 kV	660 (26")
	46 kV	787 (31")
	72 kV	1016 (40")

Notes:

Type BR is similar to button head shown, except that the button head is attached via a ¼ UNF thread.

Tails can be cut to any length.

ASL - Automatic Sectionalising Links

- Low cost retrofit option for spur line isolation in place of existing expulsion fuse links.
- Available for up to 33 kV lines.
- Standard pick-up current ratings of 20, 25, 40, 50, 63, 100 Amps.
- Other ratings up to 320 Amps available.
- Available in single or 3-phase ganged arrangements.
- Enhanced lightning immunity performance.

Bussmann Automatic Sectionalising Link ASL (smart links)

Bussmann low cost retrofit Automatic Sectionalising Link (ASL), represents a significant breakthrough in the field of high voltage overhead line distribution system protection. It is a completely self-contained device designed for use with multi-shot circuit breakers or auto-reclosers. The ASL was originally developed by Bussmann from invention by the Electrical Council Research Centre, now EA technology in the UK.

Bussmann ASL ensures effective overhead spur line isolation in the event of a genuine local fault, while at the same time remaining unresponsive to transient (temporary) no-damage surge currents, caused by electrical storms etc, see figure 1.

How the sectionaliser works

The sectionaliser houses a logic circuit in its main conductive carrying tube. This ensures the electronic circuitry is free from electrical interference, as the tube acts as an effective Faraday cage and is powered by a small current transformer mounted on the outside of the carrier tube.

Statistics show that 90% of expulsion fuse operations on spur lines are in response to transient no-damage faults and that the cost for each expulsion fuse link replacement can be of the same order as the capital cost of a complete fuse cut-out. The alternative approach favoured by some Utilities of replacing expulsion fuse links by solid links has the major disadvantage that any permanent fault on a spur line results in an outage of the whole system.

Bussmann ASL provides an economic solution to the problem, by ensuring effective spur line isolation in the event of a genuine local fault, while at the same time remaining unresponsive to transient no-damage surge currents.

Operation is accomplished by discharging a capacitor into a small chemical actuator (or 'striker') which unlatches the carrier tube and causes it to swing down. The ASL is reset by fitting a replacement actuator and re-inserting the carrier into its mount.

The logic circuit is designed to inhibit response to transformer magnetising inrush current surges and induced current waves resulting from electrical storms. Therefore, in practice any spur line fault condition which persists for a time of several seconds will operate the ASL, so isolating the spur as explained above. Any transient or 'no damage' current will be ignored.



Operational sequence

The logic circuit on the printed circuit board within the ASL is powered by a small current transformer mounted on the outside of the conductive carrier tube. Under normal load conditions the printed circuit board remains inert. However, should the line current increase above a certain pre-set value (the pick-up current) the logic circuit activates. The upstream auto re-closer then opens, temporarily removing the fault from the line. The logic circuit, powered by an internal capacitor, stores the incident for around 25 seconds (the 'reclaim' time). When the upstream device recloses, some three to ten seconds later, if the fault current is no longer in evidence, the ASL will ignore the incident and eventually reverts to an inert state again. However if the fault current (i.e. a current above the pick-up value) is still present, the logic circuit will decide that this represents a permanent fault on the spur line and will prepare to de-latch. The logic circuit is however, inhibited from operating the latch mechanism until the upstream recloser has tripped for the second time and the line current has fallen to a value of less than 300mA (the 'hold-off' current) for a period of at least 0.1 second. The ASL thus operates during the dead time of the upstream protective device and does so quietly, without sparks or ionised gas emission and without contact erosion.

ASL - Automatic Sectionalising Links

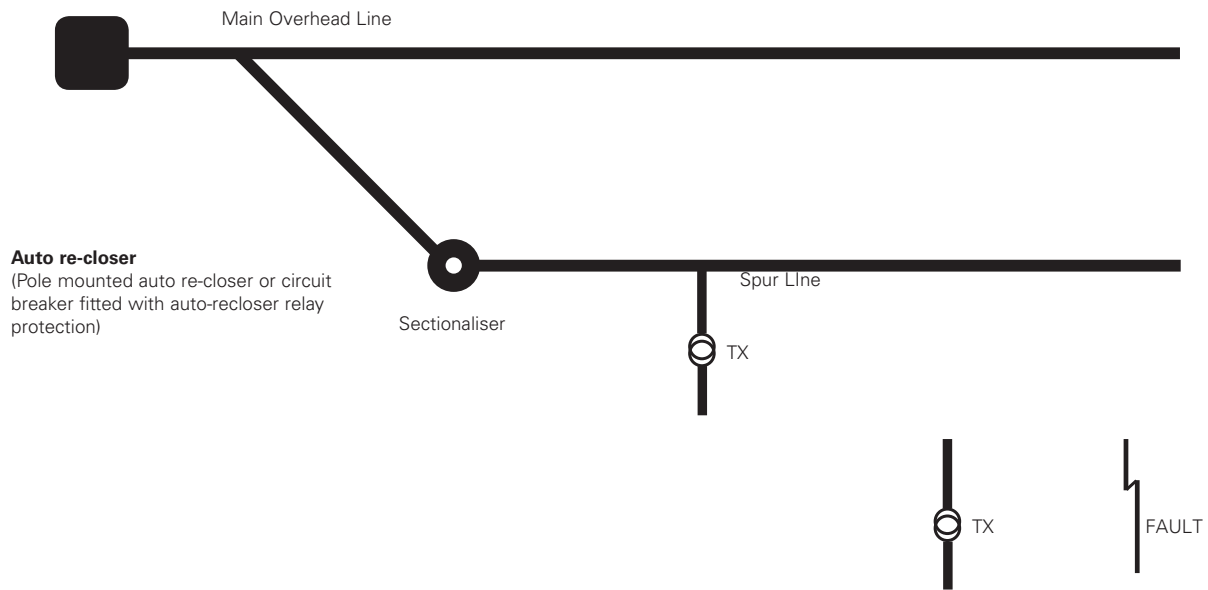
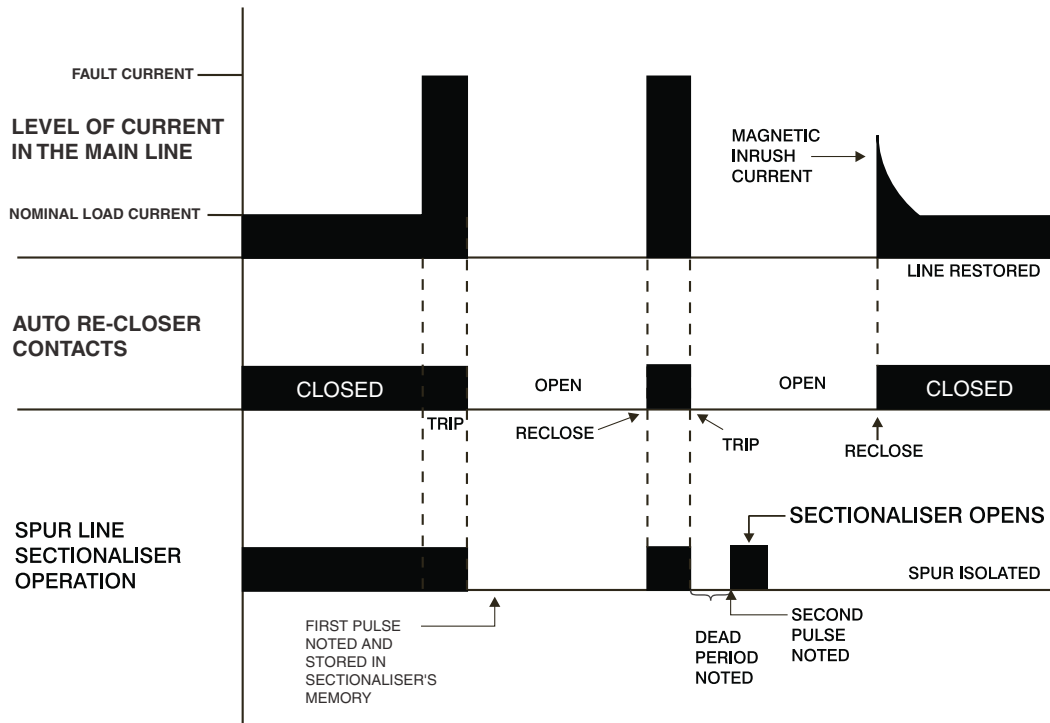
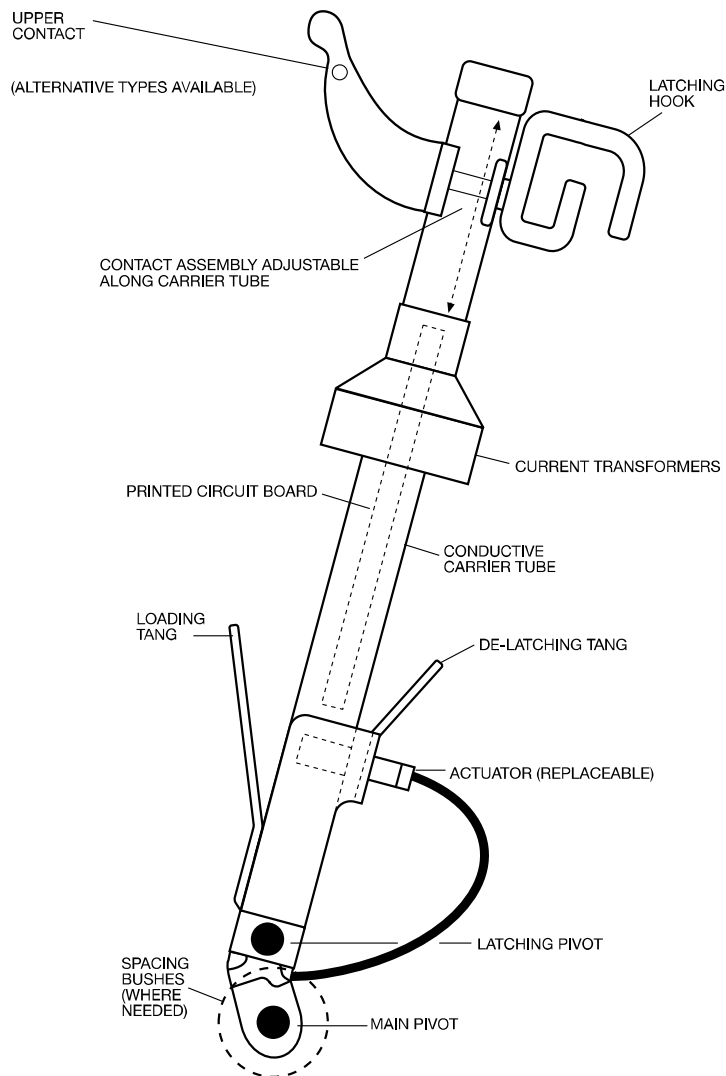

Figure 1



Sectionaliser isolating a spur-line fault

ASL - Automatic Sectionalising Links



Mounting arrangements

The contact assemblies of the ASL are adjustable to allow for use with a variety of types of expulsion fuse mount. Alternative upper contact assemblies are available. These can be either fitted to the ASL during manufacture or may be provided loose as conversion kits. ASLs can also be provided complete with suitable 'fuse mounts' where required.

Applications

The ASL must be used in conjunction with either an upstream circuit breaker having multi-shot reclose facility or an auto-recloser. In either case the dead time of the device must be appreciably less than the 25 second ASL reclaim time.

The most useful pick-up current setting is likely to be 100A. This will allow protection of spur line loads totalling up to 1000 kVA 3-phase (11 kV).

Where the total load is smaller and greater sensitivity to low level faults is required, one of the alternative lower settings can be supplied. It should be noted that the recommended pick-up current setting is approximately twice the value of the maximum load current of the connected downstream transformers.

ASL - Automatic Sectionalising Links

Additional information

- Response time: At inception < 50 ms
- Weight: 1.6 kg
- Maximum recommended mounting height: 10 metres
- Hold off current: > 300 mA
- The three-phase version is available to suit Moris Line Equipment mounts only, ref. BR1T

Mounting references		
Bussmann reference	Suitable for mount type	Actuator part numbers
BR1	S & E Line Equipment, pre. 1967	4772968BS
BR2	Brush Power (1967 - 1987)	4772968BS
BR3	Hawker Switchgear	4772968BS
BR5	J & P (GEC)	4772964BS
BR1M	Morris Line Equipment	4772968BS
BR1T	Morris Line Triple Pole Unit	4772968BS
C	Universal USA, NEMA	4772968BS
	Replacement pack of 100 grease sachets	4772717BS

Ordering codes					
Symbol					
Rating voltage	Product type	Pick-up current in amps	Mounting arrangements	Number of shots	Meaning
15					Sectionaliser to be used in 15 kV cut-outs
	ASL				Automatic Sectionalising Link (ASL)
		100			The pick-up current will be set at 100 Amps
			BR1		Details the contact arrangement for a given fuse mount. (See mounting references in the table above)
				2	Details the number of current pulses, or shots, the unit will accept before operating either 1, 2 or 3 multi.
15	ASL	100	BR1	2	Total Part numbers
For example: 15ASL100BR1-2					

Boric acid fuse links

- Expulsion style fuse link complete with a single-pole porcelain fuse mount.
- Available from 17 kV to 38 kV, 3 to 200A.
- Can be used indoors and outdoors.
- ANSI C.37 and Australian standard AS1033.

Introduction

Bussmann BBU medium voltage boric acid fuse link and complementary fuse mount or cut-out package is an expulsion fuse link style fuse, complete with a single-pole porcelain fuse mount offering medium voltage protection for indoor and outdoor applications.

The fuse mount is available at either 17 or 27 kV and is designed to withstand the most hazardous environmental conditions. The contact system is made from a copper alloy ensuring a long service life in the field.

The fuse mount already has the outdoor fittings, so simply adding a Bussmann BBU fuse link will deliver a complete outdoor transformer protection solution.

Bussmann range of BBU fuse links can be used indoors as well as outdoors. A muffler attachment can be ordered to limit noise and contamination to indoor equipment during operation.

BBU fuse links are designed to be interchangeable with other leading manufacturers and are available from 17 kV through to 38 kV, from 3 to 200 amps, with K, E and SE time-current characteristics.

Boric acid fuse link employs calibrated silver elements combined with boric acid crystals for its interruption media. The mechanical utilisation of the spring and rod mechanism creates an interruption technique that offers mild exhaustion during fault interruption.

Boric acid fuse links are ideally suited to provide distribution transformer protection within electrical distribution networks.

Features of BBU Fuses

A complete distribution transformer package from a single source. Bussmann offers a single source for all of your protection needs, both fuse links and fuse mount are fully interchangeable with other manufacturers product lines.

Sealed fuse links - All BBU fuse links are sealed from moisture ingress, preventing deterioration of performance in the fields and improving overall network reliability while reducing costs.

Fully tested - Bussmann BBU fuse links are tested to both ANSI C.37 and Australian standard AS1033.1, which due to Australia's unique landscape and harsh climate, is widely regarded as the most onerous type test of expulsion fuse link style protection in the world today.

Single piece end fittings - Bussmann fuse link package comes with single piece end fittings, reducing set-up time in the field and lowering inventory, thereby improving network productivity.

Single wrench installation - The fuse links are designed to be installed with a single type of tool, again reducing maintenance, replacement and installation costs.

Other features to improve safety and overall reliability induce the use of a Nichrome strain element, to reduce susceptibility to spurious operation in the field caused by vibration and corona, a glass epoxy tube, preventing warping during long time exposure and permanent date marking facilitating a more robust operation and maintenance regime.

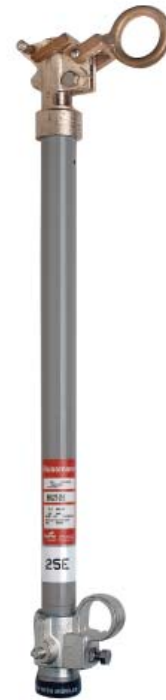

Boric acid fuse links

BBU Fuse link mount construction

Bird proof design insulator provides insulation characteristics higher than ANSI distribution cut-out standards and equal in most cases to ANSI switch and bus standards

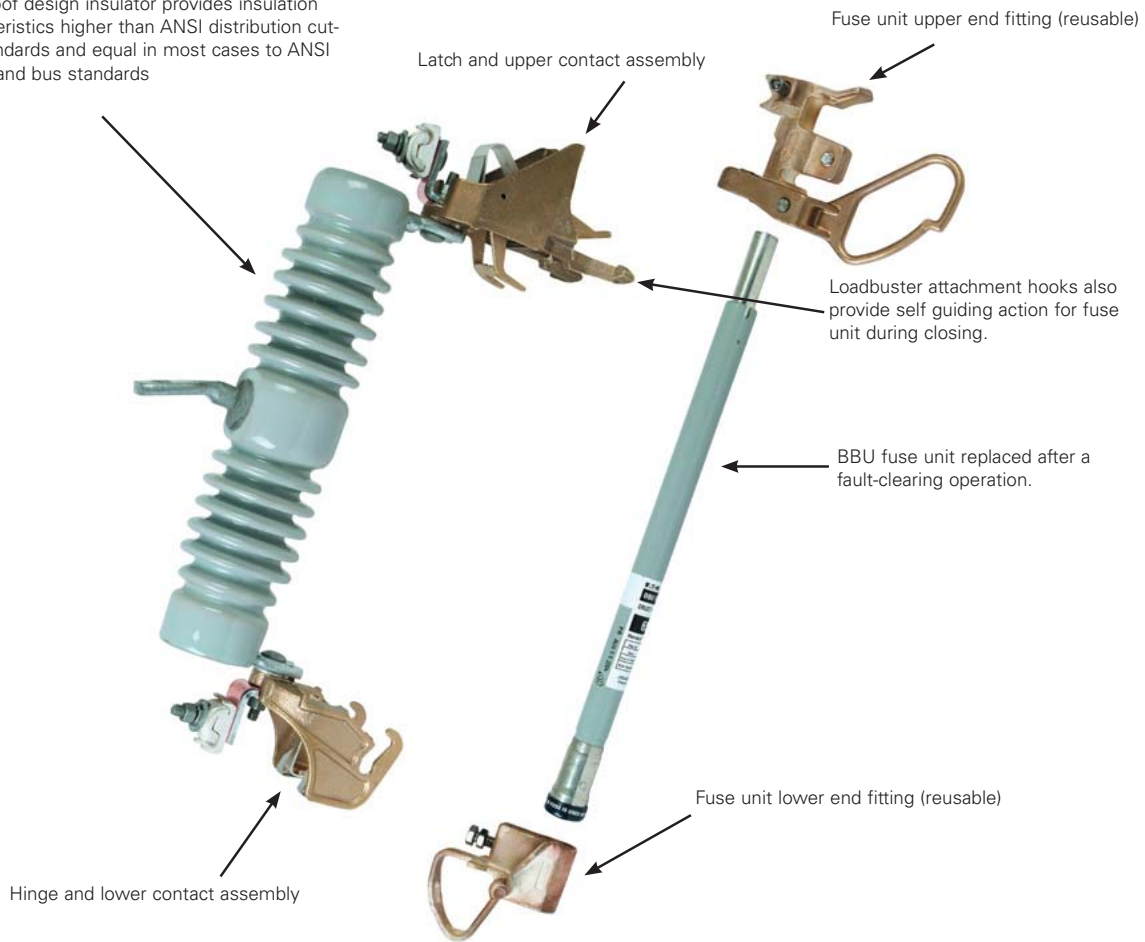

BBU Fuse construction

Principle parts of the replaceable BBU fuse unit are shown in the cross section view. Main operating parts are the silver element, arcing rod, boric acid cylinder and spring. A glass epoxy tube encloses the assembly.

The use of a pure silver element and Nichrome wire stain element makes the BBU less susceptible to outages caused by vibration, corona corrosion, and aging of the fuse elements. It is not damaged by transient faults or overloads which approach the minimum melt point.

The components are housed in a fiberglass reinforced resin tube with plated copper contacts. Positive connection is maintained between the arcing rod and contact with a sliding tulip contact.



BBU End fittings



Fuse unit lower end fitting.
Part number (including muffler):
BBU-EFID



Fuse unit upper end fitting.
Part number (including muffler):
BBU-EFID



Muffler part number: BBU-MFLR

Boric acid fuse links

Operation

BBU expulsion fuse links utilise the proven performance of boric acid to create the de-ionizing action needed to interrupt the current. Fault interruption is achieved by the action of an arcing rod and a charged spring, elongating the arc through a boric acid chamber upon release by the fuse element.

At high temperatures, boric acid decomposes, producing a blast of water vapor and inert boric anhydride. Electrical interruption is caused by the steam extinguishing the arc, as the arc is being elongated through the cylinder.

Higher particle turbulence of the boric acid causes the rate of de-ionization in the cylinder to exceed the ionization of the electrical arc. Both high and low current faults are interrupted in the same manner with no foreign material other than the boric acid required. This enables the fuse to interrupt short-circuit within one half cycle and prevents the arc from restriking after a current zero.

After interruption, the gases are expelled from the bottom of the fuse.

The arching rod is prevented from falling back into its original position by a friction stop at the top of the fuse unit.

When the fuse operates, the upward motion of the spring forces the top of the arching rod to penetrate the upperseal, striking the latch mechanism.

On indoor applications, this action caused the blown fuse indicator to actuate.

When replacing the blown fuse link, the end fittings should be removed from the operated fuse unit, and if undamaged, clamped onto the new fuse unit.

Application

The BBU Boric acid fuse provides effective protection for circuits and equipment which operate on voltage system up to 34.5 kV. They can be used on industrial distribution systems and all fuses are designed for use on the following:

- Power transformers.
- Feeder circuits.
- Distribution transformers.
- Metal-enclosed switchgear.
- Pad mount switches.

BBU fuse units can be used in indoor applications, and can be used to directly replace competitive equivalent units.

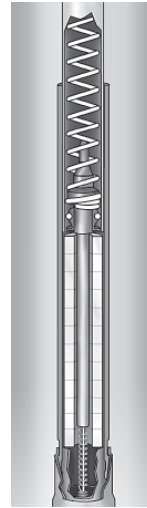

Elements melts

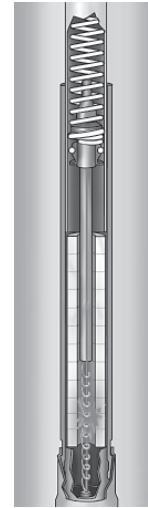

Rod withdraws elongating arc and vaporizing boric acid



Vapor quenches arc at first current zero

Boric acid fuse links

Outdoor BBU Mount

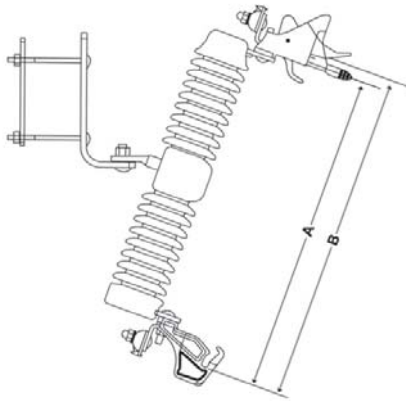

BBU27-PDM

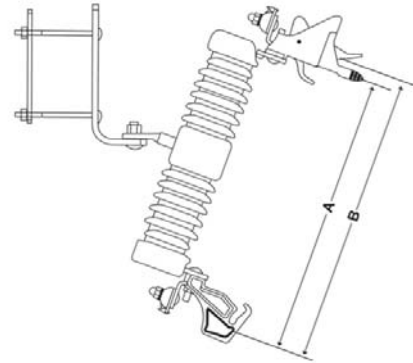

BBU17-PDM

Part numbers and technical data

Part numbers	1Min High voltage withstand test kV	Total insulator length inches (mm)	A inches (mm)	B inches (mm)	Approximate weight (kg)
BBU27-PDM	42	18.3 (465)	20.4 (516.9)	21 (534)	20
BBU17-PDM	35	14.8 (375)	16.8 (426.9)	17.5 (444)	17.5

Outdoor BBU Fuse fitting

Outdoor end fittings are made of a cast-copper plated alloy. A large hook eye on the upper fitting allows for easy installation into pole-top mountings with a hook stick. The pivotal design of this hook eye provides for proper engagement of the upper live part. The positive locking action of the latch mechanism prevents detachment from the mounting due to shock or vibration. In the event of a fault, the arcing rod will penetrate through the upper end of the fuse unit, and cause the latch to release. Once released, the fuse will rotate down into the drop-out position to indicate a blown fuse condition. The lower end fitting has two cylindrical posts that insert into the lower live part of the mounting. These posts allow the fuse to rotate into the proper engaged position, and suspend the fuse during a blown, drop-out condition.

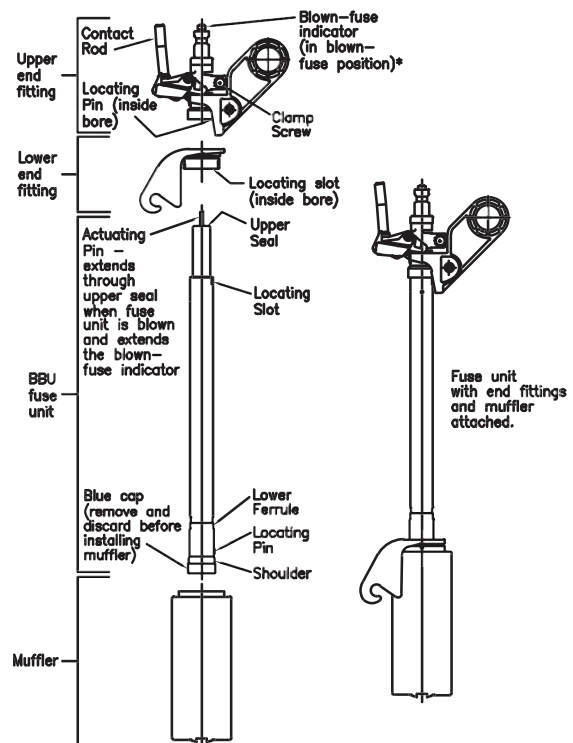

Boric acid fuse links

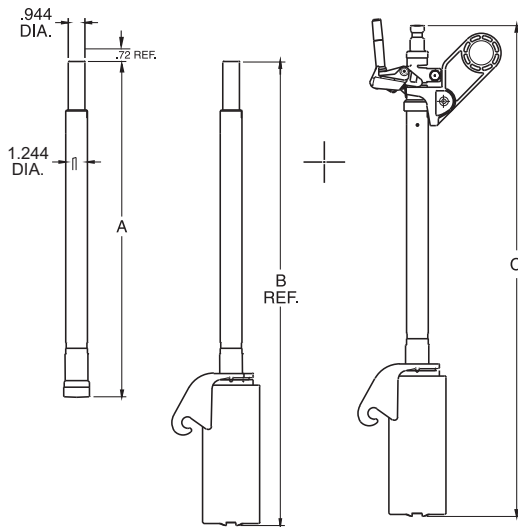

Fuse dimensions

kV max	Fuse unit fitting inches (mm)		
	A	B	C
17	198 (484)	27.19 (690)	28.82 (732)
27	22.58 (573)	30.69 (779)	32.32 (821)
38	28.76 (730)	36.87 (936)	38.50 (978)

Application notes

Low currents, usually referred to as overload currents, must be considered as BBU fuses have a rather low thermal capacity. They cannot carry overloads of the same magnitude/duration as motors and transformers of equal continuous currents. For this reason, the BBU fuse must be sized with the load current in mind so the fuse does not open on otherwise acceptable overloads and inrush conditions. Coordination should be considered to help determine what type of fuse is applied. The BBU fuse interrupts at a natural current zero in the current wave and allows minimum of a half-cycle of fault current to flow before the fault is cleared. The time-current characteristics associated with a BBU fuse has a rather gradual slope making it easier to coordinate with downstream equipment. In addition, the BBU is ideal for higher voltage (up to 38 kV) and high current applications (up to 200A). It is important to examine the minimum melting and total clearing time-current characteristics of this fuse.

Standards

Bussmann does not compromise when performance, quality and safety are involved. Exacting standards have been established relative to the design, testing and application of expulsion type power fuses. Compliance with these standards ensures the best selection and performance. The BBU Power fuses are designed and tested for compliance to global standards such as ANSI and Australian standard AS1033.1 1990. ANSI (American National Standards Institute) is a non-profit privately funded membership organization that coordinates the development of the US voluntary national standards.

Testing

Bussmann BBU Power fuse links and fuse mounts were tested in compliance to the standards listed below. This testing was carried out in independent test laboratories in Canada and in Australia by recognised independent power testings laboratories. Thermal and interrupting testing was conducted at 17, 27 kV. The entire series of tests was conducted in a specific sequence as stipulated by governing standards without any maintenance being performed. All tests results are verified by laboratory tabulations and oscillogram plots.

- ANSI C37.40 - Service conditions and definitions.
- ANSI C37.41 - Power fuse design and testing.
- ANSI C37.42 - Distribution fuse ratings and specification.
- ANSI C37.46 - Power fuse ratings and specifications.
- ANSI C37.48 - Power fuse application, operation and maintenance.
- AS1033.1 1990 - Australian standard high voltage fuses expulsion type.

Specifications

Description

Expulsion fuse link style fuse, complete with a single pole porcelain fuse mount offering medium voltage protection for indoor and outdoor applications.

Ratings

Voltage: 17 - 38 kV (for the fuse link)

7 and 27 kV (for the fuse mount)

Amps: 3 - 200 A (for the fuse link)

IR: 10, 12 or 14 kA

Time-current curves

see curves on CD at the back of the catalogue.

Agency information

Refer to the 'Standards' paragraph.

Typical applications

- Power transformers.
- Feeder circuits.
- Distribution transformers.
- Metal enclosed switchgear.
- Pad mount switches.

Boric acid fuse links

Part numbers and technical data

Part numbers	Current (A)	Voltage (kV)	Breaking capacity kA	Fuse type
BBU17-3K	3	17	14	K
BBU17-6K	6	17	14	K
BBU17-8K	8	17	14	K
BBU17-10K	10	17	14	K
BBU17-12K	12	17	14	K
BBU17-15K	15	17	14	K
BBU17-20K	20	17	14	K
BBU17-25K	25	17	14	K
BBU17-30K	30	17	14	K
BBU17-40K	40	17	14	K
BBU17-50K	50	17	14	K
BBU17-65K	65	17	14	K
BBU17-80K	80	17	14	K
BBU17-100K	100	17	14	K
BBU17-140K	140	17	14	K
BBU17-200K	200	17	14	K
BBU17-5E	5	17	14	E
BBU17-7E	7	17	14	E
BBU17-10E	10	17	14	E
BBU17-13E	13	17	14	E
BBU17-15E	15	17	14	E
BBU17-20E	20	17	14	E
BBU17-25E	25	17	14	E
BBU17-30E	30	17	14	E
BBU17-40E	40	17	14	E
BBU17-50E	50	17	14	E
BBU17-65E	65	17	14	E
BBU17-80E	80	17	14	E
BBU17-100E	100	17	14	E
BBU17-125E	125	17	14	E
BBU17-150E	150	17	14	E
BBU17-175E	175	17	14	E
BBU17-200E	200	17	14	E
BBU17-15SE	15	17	14	SE
BBU17-20SE	20	17	14	SE
BBU17-25SE	25	17	14	SE
BBU17-30SE	30	17	14	SE
BBU17-40SE	40	17	14	SE
BBU17-50SE	50	17	14	SE
BBU17-65SE	65	17	14	SE
BBU17-80SE	80	17	14	SE
BBU17-100SE	100	17	14	SE
BBU17-125SE	125	17	14	SE
BBU17-150SE	150	17	14	SE
BBU17-175SE	175	17	14	SE
BBU17-200SE	200	17	14	SE

Part numbers	Current (A)	Voltage (kV)	Breaking capacity kA	Fuse type
BBU27-3K	3	27	12.5	K
BBU27-6K	6	27	12.5	K
BBU27-8K	8	27	12.5	K
BBU27-10K	10	27	12.5	K
BBU27-12K	12	27	12.5	K
BBU27-15K	15	27	12.5	K
BBU27-20K	20	27	12.5	K
BBU27-25K	25	27	12.5	K
BBU27-30K	30	27	12.5	K
BBU27-40K	40	27	12.5	K
BBU27-50K	50	27	12.5	K
BBU27-65K	65	27	12.5	K
BBU27-80K	80	27	12.5	K
BBU27-100K	100	27	12.5	K
BBU27-140K	140	27	12.5	K
BBU27-200K	200	27	12.5	K
BBU27-5E	5	27	12.5	E
BBU27-7E	7	27	12.5	E
BBU27-10E	10	27	12.5	E
BBU27-13E	13	27	12.5	E
BBU27-15E	15	27	12.5	E
BBU27-20E	20	27	12.5	E
BBU27-25E	25	27	12.5	E
BBU27-30E	30	27	12.5	E
BBU27-40E	40	27	12.5	E
BBU27-50E	50	27	12.5	E
BBU27-65E	65	27	12.5	E
BBU27-80E	80	27	12.5	E
BBU27-100E	100	27	12.5	E
BBU27-125E	125	27	12.5	E
BBU27-150E	150	27	12.5	E
BBU27-175E	175	27	12.5	E
BBU27-200E	200	27	12.5	E
BBU27-15SE	15	27	12.5	SE
BBU27-20SE	20	27	12.5	SE
BBU27-25SE	25	27	12.5	SE
BBU27-30SE	30	27	12.5	SE
BBU27-40SE	40	27	12.5	SE
BBU27-50SE	50	27	12.5	SE
BBU27-65SE	65	27	12.5	SE
BBU27-80SE	80	27	12.5	SE
BBU27-100SE	100	27	12.5	SE
BBU27-125SE	125	27	12.5	SE
BBU27-150SE	150	27	12.5	SE
BBU27-175SE	175	27	12.5	SE
BBU27-200SE	200	27	12.5	SE

The BBU fuse is offered in three constructions to meet specific melt curves for an application. The construction is designated in the Part numbers suffix: E (Standard), K (Fast) and SE (Slow). Contact Bussmann for application details: buletechnical@eaton.com

Boric acid fuse links

Part numbers and technical data

Part numbers	Current (A)	Voltage (kV)	Breaking capacity kA	Fuse type
BBU38-3K	3	38	10	K
BBU38-6K	6	38	10	K
BBU38-8K	8	38	10	K
BBU38-10K	10	38	10	K
BBU38-12K	12	38	10	K
BBU38-15K	15	38	10	K
BBU38-20K	20	38	10	K
BBU38-30K	30	38	10	K
BBU38-40K	40	38	10	K
BBU38-50K	50	38	10	K
BBU38-65K	65	38	10	K
BBU38-80K	80	38	10	K
BBU38-100K	100	38	10	K
BBU38-140K	140	38	10	K
BBU38-200K	200	38	10	K
BBU38-5E	5	38	10	E
BBU38-7E	7	38	10	E
BBU38-10E	10	38	10	E
BBU38-13E	13	38	10	E
BBU38-15E	15	38	10	E
BBU38-20E	20	38	10	E
BBU38-25E	25	38	10	E
BBU38-30E	30	38	10	E
BBU38-40E	40	38	10	E
BBU38-50E	50	38	10	E
BBU38-65E	65	38	10	E
BBU38-80E	80	38	10	E
BBU38-100E	100	38	10	E
BBU38-125E	125	38	10	E
BBU38-150E	150	38	10	E
BBU38-175E	175	38	10	E
BBU38-200E	200	38	10	E
BBU38-15SE	15	38	10	SE
BBU38-20SE	20	38	10	SE
BBU38-25SE	25	38	10	SE
BBU38-30SE	30	38	10	SE
BBU38-40SE	40	38	10	SE
BBU38-50SE	50	38	10	SE
BBU38-65SE	65	38	10	SE
BBU38-80SE	80	38	10	SE
BBU38-100SE	100	38	10	SE
BBU38-125SE	125	38	10	SE
BBU38-150SE	150	38	10	SE
BBU38-175SE	175	38	10	SE
BBU38-200SE	200	38	10	SE

Cross reference

DIN Fuse links									
Bussmann	EFEN	SIBA	MESA	ETI (80N Striker)	ETI (50N Striker)	Merlin Gerin	Elimsan	Inael	ABB
3.6 kV									
3.6ADOSJ6.3	67110060	3000213	CF-7.2/6.3	4226005	4225005	51006 500 M0	N/A	3.6 IB-D2 6.3	1YMB531001M0001
3.6ADOSJ10	67110100	3000213	CF-7.2/10	4226006	4225006	51007 501 M0	N/A	3.6 IB-D2 10	1YMB531001M0002
3.6ADOSJ16	67110160	3000213	CF-7.2/16	4226007	4225007	51008 502 M0	N/A	3.6 IB-D2 16	1YMB531001M0003
3.6ADOSJ20	67110200	3000213	CF-7.2/20	4226008	4225008	51009 503 M0	N/A	3.6 IB-D2 20	N/A
3.6ADOSJ25	67110250	3000213	CF-7.2/25	4226009	4225009	51010 504 M0	N/A	3.6 IB-D2 25	1YMB531001M0000
3.6ADOSJ31.5	67110320	3000213	CF-7.2/31.5	4226010	4225010	51011 505 M0	N/A	3.6 IB-D2 31.5	N/A
3.6ADOSJ40	67110400	3000213	CF-7.2/40	4226011	4225011	51012 506 M0	N/A	3.6 IB-D2 40	1YMB53100M0005
3.6WDOSJ50	67110500	3000213	CF-7.2/50	4226012	4225012	51013 507 M0	N/A	3.6 IB-D2 50	1YMB531001M0006
3.6WDOSJ63	67110630	3001013	CF-7.2/63	4226013	4225013	51014 508 M0	N/A	3.6 IB-D2 63	1YMB531001M0007
3.6WDOSJ80	67110800	3001013	CF-7.2/80	4226014	4225014	51015 509 M0	N/A	3.6 IB-D2 80	1YMB531001M0008
3.6WDOSJ100	67110.1000	3001013	CF-7.2/100	4226015	4225015	51016 510 M0	N/A	3.6 IB-D2 100	1YMB531001M0009
3.6WDOSJ125	67110.1250	3001013	N/A	4226016	4225016	N/A	N/A	N/A	N/A
3.6WFOSJ160	67110.1600	3001813	N/A	4226017	4225017	N/A	N/A	N/A	N/A
3.6WFOSJ200	67210.2000	3001814	N/A	N/A	N/A	N/A	N/A	N/A	N/A
7.2 kV									
7.2TDLSJ6.3	N/A	3009813	N/A	N/A	N/A	N/A	N/A	N/A	1YMB531034M0001
7.2TDLSJ10	N/A	3009813	N/A	N/A	N/A	N/A	N/A	N/A	1YMB531034M0002
7.2TDLSJ16	N/A	3009813	N/A	N/A	N/A	N/A	N/A	N/A	1YMB531034M0003
7.2TDLSJ20	N/A	3009813	N/A	N/A	N/A	N/A	N/A	N/A	N/A
7.2TDLSJ25	N/A	3009813	N/A	N/A	N/A	N/A	N/A	N/A	1YMB531034M0004
7.2TDLSJ31.5	N/A	3009813	N/A	N/A	N/A	N/A	N/A	N/A	N/A
7.2TDLSJ40	N/A	3009813	N/A	N/A	N/A	N/A	N/A	N/A	1YMB531034M0005
7.2TDLSJ50	N/A	3009813	N/A	N/A	N/A	N/A	N/A	N/A	1YMB531034M0006
7.2TDLSJ63	N/A	3009913	N/A	N/A	N/A	N/A	N/A	N/A	1YMB531034M0007
7.2TFLSJ80	N/A	3009913	N/A	N/A	N/A	N/A	N/A	N/A	1YMB531034M0008
7.2TFLSJ100	N/A	3009913	N/A	N/A	N/A	N/A	N/A	N/A	1YMB531034M0009
7.2TFLSJ125	N/A	3009913	CF-7.2/125	N/A	N/A	757352 BN	N/A	N/A	1YMB531034M0010
7.2TFLSJ160	N/A	3010013	CF-7.2/160	N/A	N/A	757352 BP	N/A	N/A	1YMB531034M0011
12 kV									
12TDLEJ6.3	67120060	3000413	CF-12/6.3	4236005	4235005	51006 511 M0	ES 6509 006	12 IB-D1 6.3	1YMB531042M0001
12TDLEJ10	67120100	3000413	CF-12/10	4236006	4235006	51006 512 M0	ES 6509 010	12 IB-D1 10	1YMB531042M0002
12TDLEJ16	67120160	3000413	CF-12/16	4236007	4235007	51006 513 M0	ES 6509 016	12 IB-D1 16	1YMB531042M0003
12TDLEJ20	67120200	3000413	CF-12/20	4236008	4235008	51006 514 M0	ES 6509 020	12 IB-D1 20	1YMB531042M0004
12TDLEJ25	67120250	3000413	CF-12/25	4236009	4235009	51006 515 M0	ES 6509 025	12 IB-D1/D2 25	1YMB531002M0004
12TDLEJ31.5	67120320	3000413	CF-12/31.5	4236010	4235010	51006 516 M0	ES 6509 030	12 IB-D1/D2 31.5	1YMB531002M0014
12TDLEJ40	67120400	3000413	CF-12/40	4236011	4235011	51006 517 M0	ES 6509 040	12 IB-D1/D2 40	1YMB531002M0005
12TDLEJ50	67120500	3000413	CF-12/50	4236012	4235012	51006 518 M0	ES 6509 050	12 IB-D2 50	1YMB531002M0006
12TDLEJ63	67120630	3001213	CF-12/63	4236013	4235013	51006 519 M0	ES 6509 063	12 IB-D2 63	1YMB531002M0007
12THLEJ80	67120800	3001213	CF-12/80	4236014	4235014	51006 520 M0	ES 6509 080	12 IB-D3 80	1YMB531002M0021
12THLEJ100	67120.1000	3001213	CF-12/100	4236015	4235015	51006 521 M0	ES 6509 100	12 IB-D3 100	1YMB531002M0022
12TKLEJ125	67120.1250	3001213	N/A	4236016	4235016	N/A	N/A	N/A	1YMB531043M0010
12TXLEJ160	67220.1600	3002013	N/A	4236017	4235017	N/A	N/A	N/A	N/A
12TXLEJ200	67220.2000	3002014	N/A	N/A	N/A	N/A	N/A	N/A	N/A
12THMEJ100	67004-1000	3010213	CF-12/100	4236515	4235515	757364CN	N/A	N/A	1YMB531035M0022
12TFMSJ160	67004-1600	3010313	CF-12/160	4236517	4235517	757354C	N/A	N/A	1YMB531035M0011

Cross reference

DIN Fuse links									
Bussmann	EFEN	SIBA	MESA	ETI (80N Striker)	ETI (50N Striker)	Merlin Gerin	Elimsan	Inael	ABB
17.5 kV									
17.5TDLSJ6.3	N/A	3025513	N/A	N/A	N/A	N/A	N/A	17.5 IB-D1 6.3	1YMB531003M0001
17.5TDLSJ10	N/A	3025513	CFR-17.5/10	N/A	N/A	51006 522 M0	N/A	17.5 IB-D1 10	1YMB531003M0002
17.5TDLSJ16	N/A	3025513	CFR-17.5/16	N/A	N/A	51006 523 M0	N/A	17.5 IB-D1 16	1YMB531003M0003
17.5TDLSJ20	N/A	3022113	N/A	N/A	N/A	N/A	N/A	17.5 IB-D1 20	1YMB531003M0013
17.5TDLSJ25	N/A	3022113	CFR-17.5/25	N/A	N/A	51006 524 M0	N/A	17.5 IB-D1/D2 25	1YMB531003M0004
17.5TDLSJ31.5	N/A	3022113	CFR-17.5/31.5	N/A	N/A	51006 525 M0	N/A	17.5 IB-D1/D2 31.5	1YMB531003M0014
17.5TDLSJ40	N/A	3022113	CFR-17.5/40	N/A	N/A	51006 525 M0	N/A	17.5 IB-D1/D2 40	1YMB531003M0021
17.5TFLSJ50	N/A	3022113	N/A	N/A	N/A	N/A	N/A	17.5 IB-D2 50	1YMB531003M0022
17.5TDM EJ6.3	N/A	3023113	N/A	N/A	N/A	N/A	N/A	17.5 IB-D1 6.3	1YMB531037M0001
17.5TDM EJ10	N/A	3023113	N/A	N/A	N/A	N/A	N/A	17.5 IB-D1 10	1YMB531037M0002
17.5TDM EJ16	N/A	3023113	N/A	N/A	N/A	N/A	N/A	17.5 IB-D1 16	1YMB531037M0003
17.5TDM EJ20	N/A	3023113	N/A	N/A	N/A	N/A	N/A	17.5 IB-D1 20	1YMB531037M0013
17.5TDM EJ25	N/A	3023113	N/A	N/A	N/A	N/A	N/A	17.5 IB-D1 25	1YMB531037M0004
17.5TDM EJ31.5	N/A	3023113	N/A	N/A	N/A	N/A	N/A	17.5 IB-D1 31.5	1YMB531037M0014
17.5TDM EJ40	N/A	3023113	N/A	N/A	N/A	N/A	N/A	17.5 IB-D1 40	1YMB531037M0021
17.5TDM EJ50	N/A	3023213	N/A	N/A	N/A	N/A	N/A	N/A	1YMB531037M0006
17.5TDM EJ63	N/A	3023213	N/A	N/A	N/A	N/A	N/A	17.5 IB-D2 63	1YMB531037M0007
17.5THMEJ80	N/A	3023213	N/A	N/A	N/A	N/A	N/A	N/A	1YMB531037M0008
17.5THMEJ100	N/A	3023313	N/A	N/A	N/A	N/A	N/A	17.5 IB-D2 100	1YMB531003M0009
17.5TKMEJ125	N/A	3023414	N/A	N/A	N/A	N/A	N/A	N/A	1YMB531003M0010
24 kV									
24TDM EJ6.3	67140060	3000613	CF-24/6.3	4256005	4255005	51006 538 M0	ES 6513-006	24 IB-D1 6.3	1YMB531044M0001
24TDM EJ10	67140100	3000613	CF-24/10	4256006	4255006	51006 539 M0	ES 6513-010	24 IB-D1 10	1YMB531044M0002
24TDM EJ16	67140160	3000613	CF-24/16	4256007	4255007	51006 540 M0	ES 6513-016	24 IB-D1 16	1YMB531044M0003
24TDM EJ20	67140200	3000613	CF-24/20	4256008	4255008	51006 541 M0	ES 6513-020	24 IB-D1 20	1YMB531044M0004
24TDM EJ25	67140250	3000613	CF-24/25	4256009	4255009	51006 542 M0	ES 6513-025	24 IB D1/D2 25	1YMB531004M0004
24TDM EJ31.5	67140320	3000613	CF-24/31.5	4256010	4255010	51006 543 M0	ES 6513-030	24 IB D1/D2 31.5	1YMB531004M0012
24TDM EJ40	67140400	3000613	CF-24/40	4256011	4255011	51006 544 M0	ES 6513-040	24 IB D1/D2 40	1YMB531004M0005
24TDM EJ50	67140500	3001413	CF-24/50	4253012	4255012	51006 545 M0	ES 6513-050	24 IB-D2 50	1YMB531004M0021
24THMEJ63	67140630	3001413	CF-24/63	4253013	4255013	51006 546 M0	ES 6513-063	24 IB-D2 63	1YMB531004M0022
24TFMEJ80	67140800	3001413	CF-24/80	4253014	4255014	51006 547 M0	ES 6513-080	24 IB-D3 80	1YMB531022M0001
24TFMEJ100	67240.1000	3002213	CF-24/100	4253015	4255015	51006 548 M0	ES 6513-100	24 IB-D3 100	1YMB531022M0002
24TXMEJ125	67240.1250	3002213	N/A	4253016	4255016	N/A	N/A	N/A	1YMB531022M0003
24TXMEJ160	67240.1600	N/A	N/A	N/A	N/A	N/A	N/A	N/A	N/A
36 kV									
36TDQSJ3.15	N/A	N/A	N/A	N/A	N/A	N/A	N/A	N/A	N/A
36TDQSJ6.3	67150060	3000813	CF-36/6.3	4266005	4265005	51006 549 M0	ES 6515-006	24 IB-D1 6.3	1YMB531006M0001
36TDQSJ10	67150100	3000813	CF-36/10	4266006	4265006	51006 550 M0	ES 6515-010	24 IB-D1 10	1YMB531006M0002
36TDQSJ16	67150160	3000813	CF-36/16	4266007	4265007	51006 551 M0	ES 6515-016	24 IB-D1 16	1YMB531006M0003
36TDQSJ20	67150200	3000813	CF-36/20	4266008	4265008	51006 552 M0	ES 6515-020	24 IB-D1 20	N/A
36TDQSJ25	67150250	3000813	CF-36/25	4266009	4265009	51006 553 M0	ES 6515-025	24 IB-D1 25	1YMB531006M0004
36TFQSJ31.5	67150320	3000813	CF-36/31.5	4266010	4265010	51006 554 M0	ES 6515-030	24 IB-D1 31.5	N/A
36TFQSJ40	67150400	3000813	CF-36/40	4266011	4265011	51006 555 M0	ES 6515-040	24 IB-D1 40	1YMB531006M0005
36TFQSJ50	67150500	3000813	CF-36/50	4266012	4265012	51006 556 M0	ES 6515-050	24 IB-D1 50	N/A
36TXQEJ63	67150630	3000813	CF-36/63	4266013	4265013	51006 557 M0	ES 6515-063	24 IB-D1 63	N/A

Cross reference

Motor fuse links			
Bussmann	SIBA	GE	ABB
3.6 kV			
3.6WDFH050	3026956-50		
3.6WDFH063	3026956-63		
3.6WDFH080	3026956-80		
3.6WDFH0100	3026956-100	K81PEX100	
3.6WDFH0125	3026956-125	K81PEX125	
3.6WFFH0160	3026956-160	K81PEX160	
3.6WFFH0200	3026956-200	K81PEX200	
3.6WFFH0250	3026956-250	K81PEX250	
3.6WKFH0315	3026956-315	K81PEX315	
3.6WKFH0355		K81PEX350 (1)	
3.6WKFH0400		K81PEX450 (2)	
3.6WFGH0100	3025513-100		1YMB531031M0001
3.6WFGH0150			1YMB531031M0002
3.6WFGH0200			1YMB531031M0003
3.6WFGH0250			1YMB531031M0004
3.6WKGH0315			1YMB531031M0005
3.6WDLSJ50	3020153-50		
3.6WDLSJ63	3020153-63		
3.6WDLSJ80	3020153-80		
3.6WDLSJ100	3020153-100		1YMB531028M0001
3.6WDLSJ125	3020253-125		
3.6WFLSJ160	3020253-160		1YMB531028M0002
3.6WFLSJ200	3020253-200		1YMB531028M0003
3.6WKLSJ250	3020054-250		1YMB531028M0004
3.6WKLSJ315	3020054-315		1YMB531028M0005
7.2 kV			
7.2WFNH050	3027156-50	K81SDX50	
7.2WFNH063	3027156-63	K81SDX63	1YMB531032M0001
7.2WFNH080	3027156-80	K81SDX80	
7.2WFNH0100	3027156-100	K81SDX100	1YMB531032M0002
7.2WFNH0125	3027156-125	K81SDX125	
7.2WFNH0160	3027156-160	K81SDX160	1YMB531032M0003
7.2WFNH0200	3027156-200	K81SDX200	1YMB531032M0004
7.2WKNH0224	3027156-224	K81SDX225	
7.2WKNH0250	3027156-250	K81SDX250	1YMB531032M0005
7.2WKNH0315	3027156-315	K81SDX315	1YMB531032M0006
7.2WFMSJ50	3010853-50		
7.2WFMSJ63	3010853-63		1YMB531029M0001
7.2WFMSJ80	3010853-80		
7.2WFMSJ100	3010853-100		1YMB531029M0002
7.2WFMSJ125	3010953-125		
7.2WFMSJ160	3010953-160		1YMB531029M0003
7.2WKMSJ200	3011054-200		1YMB531029M0004
7.2WKMSJ224	3011054-224		
7.2WKMSJ250	3011054-250		1YMB531029M0005
7.2WKMSJ315	3011054-315		1YMB531029M0006

Voltage and auxiliary fuse links			
Bussmann	SIBA	GE	
3.6 kV			
3.6ABWNA3.15		AIR3.3/3	
7.2 kV			
7.2ABWNA3.15	3038311-3	VTF6.6/3	
7.2ABCNA3.15	3037711-3		
7.2OBCNA3.15		VTF6.6/3	
12 kV			
12ABCNA3.15	3037811-3	VTF11/3	
12ABCN223.15		5XVTF11/3	
12OBCNA3.15		VTF11/3	
12OBCN223.15		5XVTF11/3	
15.5 kV			
15.5ABFNA3.15		VTF15/3	
15.5OBFNA3.15		VTF15/3	
15.5ABFNA223.15		6XVTF15/3	
15.5OBFN223.15		6XVTF15/3	
17.5 kV			
17.5ABGNA3.15	3037911-3		
24 kV			
24ABGNA3.15	3038011-3		

Please note the Bussmann fuse links above are rated at 3.15A. GE and Siba's are rated at 3A.

(1) GE's fuse link is rated 355A, Bussmann's 350A
 (2) GE's fuse link is rated at 450A, Bussmann's at 400A

Cross reference

Oil fuse links			
Bussmann	Siba	GE	Notes
3.6 kV			
3.60EFMA6.3	3013236-6.3*		Bussmann fuse link can only be used at a maximum of 3.6 kV
3.60EFMA10	3013236-10*		Bussmann fuse link can only be used at a maximum of 3.6 kV
3.60EFMA16	3013236-16*		Bussmann fuse link can only be used at a maximum of 3.6 kV
3.60EFMA20	3013236-20*		Bussmann fuse link can only be used at a maximum of 3.6 kV
3.60EFMA25	3013236-25*		Bussmann fuse link can only be used at a maximum of 3.6 kV
3.60EFMA31.5	3013236-31.5*		Bussmann fuse link can only be used at a maximum of 3.6 kV
3.60EFMA40	3013236-40*		Bussmann fuse link can only be used at a maximum of 3.6 kV
3.60EFMA50	3013236-50*		Bussmann fuse link can only be used at a maximum of 3.6 kV
3.60EFMA63	3013236-63*		Bussmann fuse link can only be used at a maximum of 3.6 kV
3.60EFMA80	3013236-80*		Bussmann fuse link can only be used at a maximum of 3.6 kV
3.60EFMA100	3013236-100*	KSBX0100	Bussmann fuse link can only be used at a maximum of 3.6 kV
7-2 kV			
7.20EFMA80	3013236-80		
7.20EFMA100	3013236-100	KSBX0100	
7.20EFMA112	3013236-112		
7.20HGMA100		KSMX0100	
7.20HGMA125	3023436-125	KSMX0120	GE fuse link is rated at 120A, Bussmann at 125A
7.20HGMA140		KSMX0140	
7.20HGMA160	3023436-160		
12 kV			
120EFMA6.3	3014436-6.3	KEBX05	GE fuse link is rated at 5A, Bussmann at 6.3A
120EFMA10	3014436-10	KEBX010	
120EFMA16	3014436-16	KEBX016	
120EMFA20	3014436-20	KEBX020	
120EFMA25	3014436-25	KEBX025	
120EFMA31.5	3014436-31.5	KEBX036	GE fuse link is rated at 36A, Bussmann at 31.5A
120EFMA40	3014436-40	KEBX040	
120EFMA50	3014436-50	KEBX050	
120EFMA63	3014436-63	KEBX063	
120HFMA80	3014436-80	KEBX080	
15.5 kV			
15.50EFMA25		KFBX025	
15.50EFMA31.5		KFBX036	GE fuse link is rated at 36A, Bussmann at 31.5A
15.50EFMA40		KFBX040	
15.50EFMA50		KFBX050	
15.50EFMA63		KFBX063	
15.50HGMA80		KFMX085	GE fuse link is rated at 85A, Bussmann at 80A
15.50LGMA100		KFMX0100	
17.5 kV			
17.50HGMA20		KFMX020	
17.50HGMA25		KFMX025	
17.50HGMA31.5		KFMX032	
17.50HGMA40		KFMX040	
17.50HGMA50		KFMX050	
17.50HGMA63		KFMX063	
17.50HGMA80		KFMX080	
24 kV			
240EGMA6.3	3023736-6.3**		
240EGMA10	3023736-10**	KTMX010***	Bussmann fuse link can only be used at a maximum 24 kV
240EGMA16	3023736-16**		
240EGMA20	3023736-20**	KTMX020***	Bussmann fuse link can only be used at a maximum 24 kV
240EGMA25	3023736-25**	KTMX025***	Bussmann fuse link can only be used at a maximum 24 kV
240EGMA31.5	3023736-31.5**	KTMX032***	Bussmann fuse link can only be used at a maximum 24 kV
240EGMA40	3023736-40**	KTMX040***	Bussmann fuse link can only be used at a maximum 24 kV
240EGMA50	3023736-50**	KTMX050***	

* SIBA fuse links are rated at 7.2 kV.

** SIBA fuse links are rated at 12 kV

*** GE fuse links are rated at 25.8 kV

Cross reference

British standard air fuse links

Bussmann	SIBA	Bussmann	SIBA	GE	Bussmann	SIBA
3.6 kV					24 kV	
3.6ADFHA6.3*	3024136-6.3	12ADFHA6.3	3014136-6.3		24ADIHA6.3	3024436-6.3
3.6ADFHA10*	3024136-10	12ADFHA10	3014136-10		24ADIHA10	3024436-10
3.6ADFHA16*	3024136-16	12ADFHA16	3014136-16		24ADIHA16	3024436-16
3.6ADFHA20*	3024136-20	12ADFHA20	3014136-20		24ADIHA20	3024436-20
3.6ADFHA25*	3024136-25	12ADFHA25	3014136-25		24ADIHA25	3024436-25
3.6ADFHA31.5*	3024136-31.5	12ADFHA31.5	3014136-31.5		24ADIHA31.5	3024436-31.5
3.6ADFHA40*	3024136-40	12AFFHA40	3013536-40		24FIHA40	3016136-40
7.2 kV		12AFFHA50	30133536-50		24AFIHA50	3016136-40
7.2ADFHA6.3	3024136-6.3	12AFFHA63	30133536-63		24AFIHA63	3016136-63
7.2ADFHA10	3024136-10	12ADFN6B31.5		K6EB32	24AFIHA80	3016136-80
7.2ADFHA16	3024136-16	12AFFN6B40		K6EB40		
7.2ADFHA20	3024136-20	12AFFN6B50		K6EB50		
7.2ADFHA25	3024136-25	12AFFN6B63		K6EB63		
7.2ADFFHA31.5	3024136-31.5	12BDGHA6.3	3024336-6.3			
7.2ADFFHA40	3024136-40	12BDGHA10	3024336-10			
7.2ADFFHA50	3024136-50	12BDGHA16	3024336-16			
7.2ADFFHA63	3024136-63	12BDGHA20	3024336-20			
7.2AFFHA80	3013536-80	12BDGHA25	3024336-25			
7.2AFFHA100	3013536-100	12BDGHA31.5	3024336-31.5			
7.2BDGHA6.3	3024236-6.3	12BDGHA40	3024336-40			
7.2BDGHA10	3024236-10	12BDGHA50	3024336-50			
7.2BDGHA16	3024236-16	12BFGHA50	3014736-50			
7.2BDGHA20	3024236-20	12BFGHA63	3014736-63			
7.2BDGHA25	3024236-25	12BFGHA80	3014736-80			
7.2BDGHA31.5	3024236-31.5	12BFGHA100	3014736-100			
7.2BDGHA40	3024236-40	12AKGHA125	3014736-125			
7.2BDGHA50	3024236-50	12BDGHC6.3	3024736-6.3			
7.2BDGHA63	3024236-63	12BDGHC10	3024736-10			
7.2BDGHA80	3024236-80	12BDGHC16	3024736-16			
7.2BFGHA100	3013736-100	12BDGHC20	3024736-20			
7.2BFGHA125	3013736-125	12BDGHC25	3024736-25			
7.2BFGHA140	3013736-140	12BDGHC31.5	3024736-31.5			
7.2BFHA160	3013736-16	12BDGHC40	3024736-40			
7.2BDGHC6.3	3024636-6.3	12BDGHC50	3024736-50			
7.2BDGHC10	3024636-10	12BFGHC63	3025036-63			
7.2BDGHC16	3024636-16	12BFGHC80	3025036-80			
7.2BDGHC20	3024636-20	12BFGHC90	3025036-90			
7.2BDGHC25	3024636-25	12BFGHC100	3025036-100			
7.2BDGHC31.5	3024636-31.5	12AKGHC125	3025036-125			
7.2BDGHC40	3024636-40	15.5 kV				
7.2BDGHC50	3024636-50	15.5BDGHC6.3	3025836-6.3			
7.2BDGHC63	3024636-63	15.5BDGHC10	3024836-10			
7.2BDGHC80	3024636-80	15.5BDGHC16	3024836-16			
7.2BFGHC90	3024936-90	15.5BDGHC20	3024836-20			
7.2BFGHC100	3024936-100	15.5BDGHC25	3024836-25			
7.2BFGHC125	3024936-125	15.5BDGHC31.5	3024836-31.5			
7.2BFGHC140	3024936-140	15.5BDGHC40	3024836-40			
7.2BFGHC160	3024936-160	15.5BFGHC50	3024836-50			
		15.5BFGHC63	3024836-63			
		15.5BFGHC80	3024836-80			

* These specific Bussmann fuse links can only be used at a maximum of 3.6 kV

US Style E-Rated fuse links				
Bussmann	Mersen (Ferraz Shawmut)	Cutler Hammer	GE	Littelfuse
5.5 kV E-Rated fuse links for transformers and feeder protection				
MV055F1DAX10E	A055F1D0R0-10E	5HLE-10E		10E-1C-5.5
MV055F1DAX15E	A055F1D0R0-15E	5HLE-15E		15E-1C-5.5
MV055F1DAX20E	A055F1D0R0-20E	5HLE-20E		20E-1C-5.5
MV055F1DAX25E	A055F1D0R0-25E	5HLE-25E		25E-1C-5.5
MV055F1DAX80E	A055F1D0R0-80E	5HLE-80E	9F62DCB080	80E-1C-5.5
MV055F1DAX125E	A055F1D0R0-125E	5HLE-125E	9F62DCB125	125E-1C-5.5
MV055F1DAX175E	A055F1D0R0-175E	5HLE-175E	9F62DCB175	175E-1C-5.5
MV055F1DAX200E	A055F1D0R0-200E	5HLE-200E	9F62DCB200	200E-1C-5.5
MV055F2DAX300E	A055F2D0R0-300E	5HLE-300E	9F62FCB300	300E-1C-5.5
MV055F2DAX350E	A055F2D0R0-350E	5HLE-350E	9F62FCB350	350E-2C-5.5
MV055F2DAX400E	A055F2D0R0-400E	5HLE-400E	9F62FCB400	400E-2C-5.5
MV055F2DAX450E	A055F2D0R0-450E	5HLE-450E	9F62FCB450	450E-2C-5.5
5.5FFNHA30E	A055F1D0R0-30E	5HLE-30E	9F60FJD030	30E-1C-5.5
5.5FFNHA40E	A055F1D0R0-40E	5HLE-40E	9F60FJD040	40E-1C-5.5
5.5FFNHA50E	A055F1D0R0-50E	5HLE-50E	9F60FJD050	50E-1C-5.5
5.5FFNHA65E	A055F1D0R0-65E	5HLE-65E	9F60FJD065	65E-1C-5.5
8.3 kV E-Rated fuse links for transformers and feeder protection				
8.25FFNHA20E	A825X20E-1	8HLE-20E	9F60FJE020	20E-1C-8.25
8.25FFNHA25E	A825X25E-1	8HLE-25E	9F60FJE025	25E-1C-8.25
8.25FFNHA30E	A825X30E-1	8HLE-30E	9F60FJE030	30E-1C-8.25
8.25FFNHA40E	A825X40E-1	8HLE-40E	9F60FJE040	40E-1C-8.25
8.25FFNHA50E	A825X50E-1	8HLE-50E	9F60FJE050	50E-1C-8.25
8.25FFNHA65E	A825X65E-1	8HLE-65E	9F60FJE065	65E-1C-8.25
15.5 kV E-Rated fuse links for transformers and feeder protection				
MV155F1DBX10E	A155F1D0R0-10E	15HLE-10E		10E-1C-15.5
MV155F1DBX80E	A155F2D0R0-80E	15HLE-80E	9F60HMH080	80E-1C-15.5
MV155F1DBX100E	A155F2D0R0-100E	15HLE-100E	9F60HMH100	100E-1C-15.5
MV155F2DBX175E	A155F2D0R0-175E	15HLE-175E		175E-2C-15.5
MV155F2DBX200E	A155F2D0R0-200E	15HLE-200E		200E-2C-15.5
15.5FFVHA15E	A155F1D0R0-15E	15HLE-15E	9F60FMH015	15E-1C-15.5
15.5FFVHA20E	A155F1D0R0-20E	15HLE-20E	9F60FMH020	20E-1C-15.5
15.5FFVHA25E	A155F1D0R0-25E	15HLE-25E	9F60FMH025	25E-1C-15.5
15.5FFVHA30E	A155F1D0R0-30E	15HLE-30E	9F60FMH030	30E-1C-15.5
15.5FFVHA40E	A155F1D0R0-40E	15HLE-40E	9F60FMH040	40E-1C-15.5
15.5FFVHA50E	A155F1D0R0-50E	15HLE-50E	9F60FMH050	50E-1C-15.5
15.5FFVHA65E	A155F2D0R0-65E	15HLE-65E	9F60FMH065	65E-1C-15.5
15.5FFVHK150E	A155F2D0R0-150E	15HLE-150E		150E-2C-15.5
E-Rated fuse links: CL-14 and bolt-in 5.5 kV				
ECL055-10E	A055C1D0R0-10E	5HCL-10E		10E-1CL-5.5
ECL055-15E	A055C1D0R0-15E	5HCL-15E		15E-1CL-5.5
ECL055-20E	A055C1D0R0-20E	5HCL-20E		20E-1CL-5.5
ECL055-25E	A055C1D0R0-25E	5HCL-25E		25E-1CL-5.5
ECL055-30E	A055C1D0R0-30E	5HCL-30E		30E-1CL-5.5
ECL055-40E	A055C1D0R0-40E	5HCL-40E		40E-1CL-5.5
ECL055-50E	A055C1D0R0-50E	5HCL-50E		50E-1CL-5.5
ECL055-65E	A055C1D0R0-65E	5HCL-65E		65E-1CL-5.5
ECL055-80E	A055C1D0R0-80E	5HCL-80E		80E-1CL-5.5
ECL055-100E	A055C1D0R0-100E	5HCL-100E		100E-1CL-5.5
ECL055-125E	A055C1D0R0-125E	5HCL-125E		125E-1CL-5.5
ECL055-150E	A055C1D0R0-150E	5HCL-150E		150E-1CL-5.5
ECL055-200E	A055C1D0R0-200E	5HCL-200E		
ECL055-250E	A055C1D0R0-250E	5HCL-250E		
ECL055-300E	A055C1D0R0-300E	5HCL-300E		300E-2CL-5.5
ECL055-400E	A055C1D0R0-400E	5HCL-400E		350E-2CL-5.5
ECL055-450E	A055C2D0R0-450E	5HCL-450E		400E-2CL-5.5
ECL055-500E	A055C2D0R0-500E	5HCL-500E		
ECL055-600E	A055C2D0R0-600E	5HCL-600E		
EBI055-750E	A055B3D0R0-750E	5HCL-750E		
EBI055-900E	A055B3D0R0-900E	5HCL-900E		

Cross reference

US Style E-Rated fuse links				
Bussmann	Mersen (Ferraz Shawmut)	Cutler Hammer	GE	Littelfuse
E-Rated fuse links: CL-14 and bolt-in - 15.5 kV				
ECL155-10E	A155C1D0R0-10E	15HCL-10E		10E-1CL-15.5
ECL155-15E	A155C1D0R0-15E	15HCL-15E		15E-1CL-15.5
ECL155-20E	A155C1D0R0-20E	15HCL-20E		20E-1CL-15.5
ECL155-25E	A155C1D0R0-25E	15HCL-25E		25E-1CL-15.5
ECL155-30E	A155C1D0R0-30E	15HCL-30E		30E-1CL-15.5
ECL155-40E	A155C1D0R0-40E	15HCL-40E		40E-1CL-15.5
ECL155-50E	A155C1D0R0-50E	15HCL-50E		50E-1CL-15.5
ECL155-65E	A155C1D0R0-65E	15HCL-65E		65E-1CL-15.5
ECL155-80E	A155C1D0R0-80E	15HCL-80E		80E-1CL-15.5
ECL155-100E	A155C1D0R0-100E	15HCL-100E		100E-1CL-15.5
ECL155-125E	A155C2D0R0-125E	15HCL-125E		
ECL155-150E	A155C3D0R0-150E	15HCL-150E		
ECL155-200E	A155C3D0R0-200E	15HCL-200E		
ECL155-250E	A155C3D0R0-250E	15HCL-250E		
ECL155-300E	A155C3D0R0-300E	15HCL-300E		
E-Rated fuses for transformers and feeder protection - 2.4 kV E-Rated indoor/enclosure				
JCX-15E		2CLE-15E		
JCX-20E		2CLE-20E		
JCX-25E		2CLE-25E		
JCX-30E		2CLE-30E	9F60ECB030	30E-1C-2.75
JCX-40E		2CLE-40E	9F60ECB040	40E-1C-2.75
JCX-50E		2CLE-50E	9F60ECB050	50E-1C-2.75
JCX-65E		2CLE-65E	9F60ECB065	65E-1C-2.75
JCX-80E		2CLE-80E	9F60ECB080	80E-1C-2.75
JCX-100E		2CLE-100E	9F60ECB100	100E-1C-2.75
JCX-125E		2CLE-125E	9F60GCB125	125E-1C-2.75
JCX-150E		2CLE-150E	9F60GCB150	150E-1C-2.75
JCX-200E		2CLE-200E	9F60GCB200	200E-1C-2.75
JCX-250E/280X		2CLE-250E		
JCX-300E/325X		2CLE-300E		
JCX-350X		2CLE-350X		
JCX-400X		2CLE-400X		
JCX-450X		2CLE-450X		
E-Rated fuse links for transformers and feeder protection - 5.5 kV E-Rated indoor/enclosure				
JCU-10E		5CLE-10E-D		
JCU-15E		5CLE-15E		
JCU-20E		5CLE-20E		
JCU-25E		5CLE-25E		
JCU-30E		5CLE-30E-D		
JCU-40E		5CLE1-40E		
JCU-50E		5CLE1-50E		
JCU-65E		5CLE1-65E		
JCU-80E		5CLE1-80E		
JCU-100E		5CLE1-100E		
JCU-125E		5CLE1-125E		
JCU-150E		5CLE-150E		
JCU-175E		5CLE-175E		
JCU-200E		5CLE-200E		
JCU-250E		5CLE-250E		
JCU-300E		5CLE-300E		
JCU-350E		5CLE-350E		
JCU-400E		5CLE-400E		
JCU-450E		5CLE-450E		
JCU-600E		5CLE-600E		
JCU-750E		5CLE-750E		

Cross reference

US style E-Rated fuse links				
Busmann	Mersen (Ferraz Shawmut)	Cutler Hammer	GE	Littelfuse
E-Rated fuse links for transformers and feeder protection - 8.3 kV E-Rated indoor/enclosure				
JCZ-15E		8CLE-15E		
JCZ-20E		8CLE-20E		
JCZ-25E		8CLE-25E		
JCZ-30E		8CLE-30E-D		
JCZ-40E		8CLE-40E		
JCZ-50E		8CLE-50E		
JCZ-65E		8CLE-65E		
JCZ-80E		8CLE-80E		
JCZ-100E		8CLE-100E		
JCZ-125E		8CLE-125E		
JCZ-150E		8CLE-150E		
E-Rated fuse links for potential and small power transformers - 2.4 kV E-Rated fuse non-indicating				
JCD-1/2E				500E-4PT-2.4
JCD-1E				1E-4PT-2.4
JCD-2E				2E-4PT-2.4
E-Rated fuse links for potential and small power transformers - 5.5 kV E-Rated fuse indicating				
JCQ-1/2E			9F60BDD905	1/2E-8PT-5.5
JCQ-1E			9F60BDD001	1E-8PT-5.5
JCQ-3E			9F60BDD003	3E-8PT-5.5
JCQ-5E				5E-8PT-5.5
JCQ-10E				10E-8PT-5.5
E-Rated fuse links for potential and small power transformers - 8.3 kV E-Rated fuse indicating				
JCI-1/2E			9F60BDE905	1/2E-8PT-8.25
JCI-3E			9F60BDE003	3E-8PT-8.25
E-Rated fuse links for potential and small power transformers - 15.5 kV E-Rated fuse indicating				
JCT-1/2E				1/2E-8PT-8.25
JCT-1E				1E-8PT-15.5
JCT-3E				3E-8PT-15.5
R-Rated fuse links for motor circuit protection - 2.4 kV				
JCK-2R	A240R2R	2CLS-2R		70-2R-1C-2.75
JCK-3R	A240R3R	2CLS-3R		100-3R-1C-2.75
JCK-4R	A240R4R	2CLS-4R		130-4R-1C-2.75
JCK-5R	A240R5R	2CLS-5R		150-5R-1C-2.75
JCK-6R	A240R6R	2CLS-6R		170-6R-1C-2.75
JCK-9R	A240R9R	2CLS-9R		200-9R-1C-2.75
JCK-12R	A240R12R	2CLS-12R		230-12R-1C-2.75
JCK-18R	A240R18R	2CLS-18R		390-18R-2C-2.75
JCK-24R	A240R24R	2CLS-24R		450-24R-2C-2.75
R-Rated fuse links for motor circuit protection				
JCK-A-2R		2ACLS-2R		70-2R-1C-2.75w
JCK-A-3R		2ACLS-3R		100-3R-1C-2.75w
JCK-A-4R		2ACLS-4R		130-4R-1C-2.75w
JCK-A-5R		2ACLS-5R		150-5R-1C-2.75w
JCK-A-6R		2ACLS-6R		170-6R-1C-2.75w
JCK-A-9R		2ACLS-9R		200-9R-1C-2.75w
JCK-A-12R		2ACLS-12R		230-12R-1C-2.75w
JCK-A-18R		2ACLS-18R		390-18R-2C-2.75w
JCK-A-24R		2ACLS-24R		450-24R-2C-2.75w
R-Rated fuse links for motor circuit protection				
JCK-B-2R		2BCLS-2R		
JCK-B-3R		2BCLS-3R		
JCK-B-4R		2BCLS-4R		
JCK-B-5R		2BCLS-5R		
JCK-B-6R		2BCLS-6R		
JCK-B-9R		2BCLS-9R		
JCK-B-12R		2BCLS-12R		
JCK-B-18R		2BCLS-18R		
JCK-B-24R		2BCLS-24R		

Cross reference

US Style E-Rated Fuse Links			
Busmann	Mersen (Ferraz Shawmut)	Cuttler Hammer	Littelfuse
R-Rated fuse links for motor circuit protection - 2.4 kV Hermetically sealed, for use with ampguard motor starters			
JCH-2R		2HCLS-2R	
JCH-3R		2HCLS-3R	
JCH-4R		2HCLS-4R	
JCH-5R		2HCLS-5R	
JCH-6R		2HCLS-6R	
JCH-9R		2HCLS-9R	
JCH-12R		2HCLS-12R	
JCH-18R		2HCLS-18R	
JCH-24R		2HCLS-24R	
R-Rated fuse links for motor circuit protection - 4.8 kV			
JCL-2R	A480R2R-1	5CLS-2R	70-2R-1C-5.5
JCL-3R	A480R3R-1	5CLS-3R	100-3R-1C-5.5
JCL-4R	A480R4R-1	5CLS-4R	130-4R-1C-5.5
JCL-5R	A480R5R-1	5CLS-5R	150-5R-1C-5.5
JCL-6R	A480R6R-1	5CLS-6R	170-6R-1C-5.5
JCL-9R	A480R9R-1	5CLS-9R	200-9R-1C-5.5
JCL-12R	A480R12R-1	5CLS-12R	230-12R-1C-5.5
JCL-18R	A480R18R-1	5CLS-18R	390-18R-2C-5.5
JCL-24R	A480R24R-1	5CLS-24R	450-24R-2C-5.5
R-Rated fuse links for motor circuit protection - 4.8 kV with Westinghouse ampguard hookeyes			
JCL-A-2R	A480R2R-1HE	5ACLS-2R	70-2R-1C-5.5w
JCL-A-3R	A480R3R-1HE	5ACLS-3R	100-3R-1C-5.5w
JCL-A-4R	A480R4R-1HE	5ACLS-4R	130-4R-1C-5.5w
JCL-A-5R	A480R5R-1HE	5ACLS-5R	150-5R-1C-5.5w
JCL-A-6R	A480R6R-1HE	5ACLS-6R	170-6R-1C-5.5w
JCL-A-9R	A480R9R-1HE	5ACLS-9R	200-9R-1C-5.5w
JCL-A-12R	A480R12R-1HE	5ACLS-12R	230-12R-1C-5.5w
JCL-A-18R	A480R18R-1HE	5ACLS-18R	390-18R-2C-5.5w
JCL-A-24R	A480R24R-1HE	5ACLS-24R	450-24R-2C-5.5w
R-Rated fuse links for motor circuit protection - 4.8 kV Bolt-on			
JCL-B-2R		5BCLS-2R	70-2R-1BI-5.5
JCL-B-3R		5BCLS-3R	100-3R-1BI-5.5
JCL-B-4R		5BCLS-4R	130-4R-1BI-5.5
JCL-B-5R		5BCLS-5R	150-5R-1BI-5.5
JCL-B-6R		5BCLS-6R	170-6R-1BI-5.5
JCL-B-9R		5BCLS-9R	200-9R-1BI-5.5
JCL-B-12R		5BCLS-12R	230-12R-1BI-5.5
JCL-B-18R		5BCLS-18R	390-18R-2BI-5.5
JCL-B-24R		5BCLS-24R	450-24R-2BI-5.5
R-Rated fuse links for motor circuit protection - 4.8 kV Hermetically sealed for use with ampguard motor starters			
JCG-2R		5HCLS-2R	
JCG-3R		5HCLS-3R	
JCG-4R		5HCLS-4R	
JCG-5R		5HCLS-5R	
JCG-6R		5HCLS-6R	
JCG-9R		5HCLS-9R	
JCG-12R		5HCLS-12R	
JCG-18R		5HCLS-18R	
JCG-24R		5HCLS-24R	

Cross reference

US Style E-Rated Fuse Links			
Bussmann	Mersen (Ferraz Shawmut)	Cutler Hammer	Littelfuse
R-Rated fuse links for motor circuit protection - 7.2 kV with ampguard			
JCR-A-2R		8ACLS-2R	70-2R-1C-8.25w
JCR-A-3R		8ACLS-3R	100-3R-1C-8.25w
JCR-A-4R		8ACLS-4R	130-4R-1C-8.25w
JCR-A-5R		8ACLS-5R	150-5R-1C-8.25w
JCR-A-6R		8ACLS-6R	170-6R-1C-8.25w
JCR-A-9R		7ACLS-9R	200-9R-1C-8.25w
JCR-A-12R		7ACLS-12R	230-12R-1C-8.25w
JCR-A-18R		7ACLS-18R	390-18R-2C-8.25w
JCR-A-24R		7ACLS-24R	450-24R-2C-8.25w
R-Rated fuse links for motor circuit protection - 7.2 kV Bolt-On			
JCR-B-2R	A072B1DAR0-2R	7BCLS-2R	70-2R-1BI-8.25
JCR-B-3R	A072B1DAR0-3R	7BCLS-3R	100-3R-1BI-8.25
JCR-B-4R	A072B1DAR0-4R	7BCLS-4R	130-4R-1BI-8.25
JCR-B-5R	A072B1DAR0-5R	7BCLS-5R	150-5R-1BI-8.25
JCR-B-6R	A072B1DAR0-6R	7BCLS-6R	170-6R-1BI-8.25
JCR-B-9R	A072B1DAR0-9R	7BCLS-9R	200-9R-1BI-8.25
JCR-B-12R	A072B1DAR0-12R	7BCLS-12R	230-12R-1BI-8.25
JCR-B-18R	A072B2DAR0-18R	7BCLS-18R	390-18R-2BI-8.25
JCR-B-24R	A072B2DAR0-24R	7BCLS-24R	450-24R-2BI-8.25
ANSI R-Rated fuse links for motor circuit protection - 2.4 kV system voltage			
2.75VFRHA2R	A240R2R	2CLS-2R	70-2R-1C-2.75
2.75VFRHA3R	A240R3R	2CLS-3R	100-3R-1C-2.75
2.75VFRHA4R	A240R4R	2CLS-4R	130-4R-1C-2.75
2.75VFRHA6R	A240R6R	2CLS-6R	170-6R-1C-2.75
2.75VKRNA9R	A240R9R	2CLS-9R	200-9R-1C-2.75
2.75VKRNA12R	A240R12R	2CLS-12R	230-12R-1C-2.75
2.75VKRHK18R	A240R18R	2CLS-18R	390-18R-2C-2.75
2.75VKRHK24R	A240R24R	2CLS-24R	450-24R-2C-2.75
ANSI R-Rated fuse links for motor circuit protection - 4.8 kV system voltage			
5.5VFNHA2R	A480R2R-1	5CLS-2R	70-2R-1C-5.5
5.5VFNHA3R	A480R3R-1	5CLS-3R	100-3R-1C-5.5
5.5VFNHA4R	A480R4R-1	5CLS-4R	130-4R-1C-5.5
5.5VFNHA6R	A480R6R-1	5CLS-6R	170-6R-1C-5.5
5.5VKNNA9R	A480R9R-1	5CLS-9R	200-9R-1C-5.5
5.5VKNNA12R	A480R12R-1	5CLS-12R	230-12R-1C-5.5
5.5VKNHK18R	A480R18R-1	5CLS-18R	390-18R-2C-5.5
5.5VKNHK24R	A480R24R-1	5CLS-24R	450-24R-2C-5.5

Cross reference

Boric acid fuse links

Bussmann		S & C Electric company	Bussmann		S & C Electric company	Bussmann		S & C Electric company
17 kV			27 kV			38 kV		
BBU17-3K		702003	BBU27-3K		703003	BBU38-3K		704003
BBU17-6K		702006	BBU27-6K		703006	BBU38-6K		704006
BBU17-8K		702008	BBU27-8K		703008	BBU38-8K		704008
BBU17-10K		702010	BBU27-10K		703010	BBU38-10K		704010
BBU17-12K		702012	BBU27-12K		703012	BBU38-12K		704012
BBU17-15K		702015	BBU27-15K		703015	BBU38-15K		704015
BBU17-20K		702020	BBU27-20K		703020	BBU38-20K		704020
BBU17-25K		702025	BBU27-25K		703025	BBU38-30K		704030
BBU17-30K		702030	BBU27-30K		703030	BBU38-40K		704040
BBU17-40K		702040	BBU27-40K		703040	BBU38-50K		704050
BBU17-50K		702050	BBU27-50K		703050	BBU38-65K		704065
BBU17-65K		702065	BBU27-65K		703065	BBU38-80K		704080
BBU17-80K		702080	BBU27-80K		703080	BBU38-100K		704100
BBU17-100K		702100	BBU27-100K		703100	BBU38-140K		704140
BBU17-140K		702140	BBU27-140K		703140	BBU38-200K		704200
BBU17-200K		702200	BBU27-200K		703200	BBU38-5E		614005
BBU17-5E		612005	BBU27-5E		613005	BBU38-7E		614007
BBU17-7E		612007	BBU27-7E		613007	BBU38-10E		614010
BBU17-10E		612010	BBU27-10E		613010	BBU38-13E		614013
BBU17-13E		612013	BBU27-13E		613013	BBU38-15E		614015
BBU17-15E		612015	BBU27-15E		613015	BBU38-20E		614020
BBU17-20E		612020	BBU27-20E		613020	BBU38-25E		614025
BBU17-25E		612025	BBU27-25E		613025	BBU38-30E		614030
BBU17-30E		612030	BBU27-30E		613030	BBU38-40E		614040
BBU17-40E		612040	BBU27-40E		613040	BBU38-50E		614050
BBU17-50E		612050	BBU27-50E		613050	BBU38-65E		614065
BBU17-65E		612065	BBU27-65E		613065	BBU38-80E		614080
BBU17-80E		612080	BBU27-80E		613080	BBU38-100E		614100
BBU17-100E		612100	BBU27-100E		613100	BBU38-125E		614125
BBU17-125E		612125	BBU27-125E		613125	BBU38-150E		614150
BBU17-150E		612150	BBU27-150E		613150	BBU38-175E		614175
BBU17-175E		612175	BBU27-175E		613175	BBU38-200E		614200
BBU17-200E		612200	BBU27-200E		613200	BBU38-15SE		714015
BBU17-15SE		712015	BBU27-15SE		713015	BBU38-20SE		714020
BBU17-20SE		712020	BBU27-20SE		713020	BBU38-25SE		714025
BBU17-25SE		712025	BBU27-25SE		713025	BBU38-30SE		714030
BBU17-30SE		712030	BBU27-30SE		713030	BBU38-40SE		714040
BBU17-40SE		712040	BBU27-40SE		713040	BBU38-50SE		714050
BBU17-50SE		712050	BBU27-50SE		713050	BBU38-65SE		714065
BBU17-65SE		712065	BBU27-65SE		713065	BBU38-80SE		714080
BBU17-80SE		712080	BBU27-80SE		713080	BBU38-100SE		714100
BBU17-100SE		712100	BBU27-100SE		713100	BBU38-125SE		714125
BBU17-125SE		712125	BBU27-125SE		713125	BBU38-150SE		714150
BBU17-150SE		712150	BBU27-150SE		713150	BBU38-175SE		714175
BBU17-175SE		712175	BBU27-175SE		713175	BBU38-200SE		714200
BBU17-200SE		712200	BBU27-200SE		713200			

Time-current curves and cut-off curves list

kV	Product range	Page number	Fuse type	Time-current curve reference	Cut-off curve reference
DIN Fuse links					
3.6	'A' and 'W' range	14	ADL	PF1001	N/A
3.6	'A' and 'W' range	14	ADO, WDO, WFO	PF1002	PF2002
7.2	'T' range	15	TDL, TFL	PF1042	PF2042
12	Full range	16	FFL	PF1067	PF2067
		16	FDL	PF1124	PF2124
		16	FXL	PF1242	PF2242
12	'A' and 'T' range	17	AIL	PF1129	N/A
		17	TXL	PF1197	PF2197
		17	TDL, THL, TKL	PF1275	PF2275
		17	TFM, THM, TKM	PF1280	PF2280
17.5	'A' and 'T' range	18-19	AIL	PF1006	PF2006
		18-19	AIM	PF1005	N/A
		18-19	TDL	PF1088	PF2088
		18-19	TFL	PF1246	PF2246
		18-19	TDM, THM, TKM	PF1274	PF2274
24	Full range	20	FDM, FFM	PF1119	PF2119
24	'A' and 'T' range	21	AFM, AIM	PF1007	PF2007
		21	TFM, TXM	PF1236	PF2236
		21	TDM, THM, TFM	PF1276	PF2276
36	'T' range	22	TDO, TFQ	PF1046	PF2046
		22	TXQ	PF1253	PF2253
Motor fuse links					
3.6	BS range	26-27	WJON	PF1079	N/A
		26-27	WDO, WFO	PF1002	PF2002
7.2	Motor BS range	28	WFN, WKN	PF1018	PF2018
3.6	Motor DIN range	30	WDO, WFO	PF1002	PF2002
		30	WDL, WFL, WKL	PF1001	N/A
7.2	Motor DIN range	31	WFM, WKM	PF1018	PF2018
Voltage and auxiliary transformer (V and T) fuse links					
1.1	'V' and 'T' range	36	NBU	PF1019	N/A
3.6	'V' and 'T' range	37	ABW, ABC	PF1020	PF2020
5.5	'E' range	38	ABW	PF1081, PF1082	PF2081
		38	AMW	PF1102, PF1103	PF2102
7.2	'V' and 'T' range	39	ABC, ABW, OBC, OBW	PF1021	PF2021
12	'V' and 'T' range	40	ABC, OBC	PF1022	PF2022
15.5	'V' and 'T' range	41	ABF, OBF	PF1061	N/A
17.5	'V' and 'T' range	42	ABG, OBG	PF1023	PF2023
24	'V' and 'T' range	43	ABG, OBG	PF1024	PF2024
36	'V' and 'T' range	44	OBG	PF1060	N/A
3.6	CAV range	45	CAV	PF1251	N/A
5.5	CAV range	46	CAV	PF1154, PF1155	N/A
		46	CAVH	PF1126	PF2126
7.2	CAV range	47	CAV	PF1250	N/A
12	CAV range	48	CAV	PF1249	N/A
15.5	CAV and CAVH range	49	CAV	PF1152, PF1153	N/A
		49	CAVH	PF1126, PF1127	PF2126
17.5	CAV range	50	CAV	PF1226	N/A
24	CAV range	51	CAV	PF1248	N/A
36	CAV range	52	CAV	PF1223	N/A
38	CAV and CAVH range	53	CAV	PF1156, PF1157	N/A
		53	CAVH	PF1126, PF1127	PF2126

Time-current curves and cut-off curves list

kV	Product range	Page number	Fuse type	Time-current curve reference	Cut-off curve reference
Oil fuse links					
3.6	BS range	56	OEF, OEG, OLG	PF1025	PF2025
7.2	BS range	57	OEF	PF1058	PF2058
		57	OHG	PF1064	PF2064
12	BS range	58	OEF, OHF	PF1053	PF2053
		58	OHG, OLG	PF1117	N/A
15.5	BS range	59	OEF, OHG, OLG	PF1056	PF2056
17.5	BS range	60	OHG	PF1057	PF2057
24	BS range	61	OEG	PF1059	PF2059
Air fuse links					
3.6	BS	64-65	ADG	PF1008	PF2008
		64-65	ADF	PF1247	N/A
7.2	BS range	66-67	ADF, AFF	PF1256	PF2256
		66-67	BDG, BFG	PF1009	PF2009
12	BS range	68-69	ADF, AFF	PF1261	N/A
		68-69	BDG, BFG, AKG	PF1010	PF2010
		68-69	FFG	PF1068	PF2068
15.5	BS range	70	BDG, BFG	PF1011	PF2011
24	BS range	71	ADI, AFI	PF1012	PF2012
		71	FDIHA	PF1094	N/A
36	BS range	72	ADI, AFI, AFK	PF1013	PF2013
72.5	BS range	73	AFK	PF1014	PF2014
E-rated fuse links					
5.5	DIN (single barrel)	75	GFM, GDM	PF1216, PF1217	PF2217
	DIN (double barrel)	75	GFM, GDM	PF1220, PF1221	PF2220
15.5	DIN (single barrel)	75	GXQ	PF1218, PF1219	PF2219
	DIN (double barrel)	75	GXQ	PF1224, PF1225	N/A
17.5	DIN (single barrel)	76	GDM, GFM, GXM, GXQ	PF1218, PF1219	N/A
	DIN (double barrel)	76	GDM, GFM, GXM, GXQ	PF1224, PF1225	PF2224
25.8	DIN (single barrel)	76	GDO, GXQ, GXZ	PF1254, PF1255	PF2254
	DIN (double barrel)	76	GDO, GXQ, GXZ	PF1257, PF1258	PF2257
38	DIN (single barrel)	76	GFX, GXZ	PF1254, PF1255	PF2254
	DIN (double barrel)	76	GFZ, GXZ	PF1257, PF1258	PF2257
5.5	E-rated for transformers	77-78	FFN	PF1107, PF1108	PF2107
	E-rated for transformers	77-78	BFN, BKN	PF1114, PF1115	N/A
8.25	E-rated for transformers	79	FFN	PF1107, PF1108	PF2107
	E-rated for transformers	79	BFN	PF1112, PF1113	N/A
15.5	E-rated for transformers	80-81	FFV	PF1107, PF1108	PF2107
5.5	E-rated for potential and small power transformers	85	AMWNA	PF1102, PF1103	PF2102
		85	ABWNA	PF1081, PF1082	PF2081
		85	CAV	PF1154, PF1155	N/A
		85	CAVH	PF1126, PF1127	PF2126
7.2	E-rated for potential and small power transformers	85	AMWNA	PF1277, PF1278	PF2277
15.5	E-rated for potential and small power transformers	85	CAV	PF1152, PF1153, PF1268, PF1269	N/A
		85	CAVH	PF1126, PF1127	PF2126
38	E-rated for potential and small power transformers	85	CAV	PF1156, PF1157	N/A
		85	CAVH	PF1126, PF1127	PF2126
Expulsion fuse links					
15 kV to 72 kV Expulsion fuse links		93-94	Type T & K	PF1047, PF1049	N/A

Index

Part numbers	Pages	Part numbers	Pages	Part numbers	Pages	Part numbers	Pages
1.1NBUN	36	24ABGN	43	36TFQSJ	22	JCH	89-90
12ABCN	40	24ADIH	71	36TXQEJ	22	JCI	84
12ADFH	68-69	24AFIH	71	38CAV	53 & 85	JCK	89-90
12AFFH	68-69	24AFMSJ	21	38GFZSJ	75-76	JCL	89-90
12AISLJ	17	24AIMSJ	21	38GXZSJ	75-76	JCL-A	89-91
12AKGH	68-69	24CAV	51	5.5ABWN	38 & 85	JCL-B	89-91
12BDGH	68-69	24FDIH	71	5.5AMWN	38 & 85	JCQ	84
12BFGH	68-69	24FDMSJ	20	5.5BFNH	77-78	JCR	89-91
12CAV2	48	24FFMSJ	20	5.5BKNH	77-78	JCT	84
12FDLSJ	16	24OBGN	43	5.5CAV	46 & 85	JCU	82-83
12FFGN	68-69	24OEGM	61	5.5FFNH	77-78	JCW	84
12FFLSJ	16	24TDMEJ	21	5.5VFNH	33	JCX	82
12FXLSJ	16	24TFMEJ	21	5.5VKNH	33	JCY	82-83
12OBCN	40	24THMEJ	21	55GDMSJ	75	JCZ	82-83
12OEFM	58	24TXMEJ	21	55GFMSJ	75	JDZ	82-83
12OHFM	58	258GDQJSJ	75-76	7.2ABCN	39	K81ERX	29
12OHGM	58	258GXQJSJ	75-76	7.2ABWN	39	KB**	93-94
12OLGM	58	258GXZSJ	75-76	7.2ADFH	66-67	KBR**	93-94
12TDLEJ	17	270303	92	7.2AFFH	66-67	KD**	93-94
12TFMSJ	17	3.6ABCN	37	7.2AMWN	39 & 85	KU**	93-94
12THLEJ	17	3.6ABWN	37	7.2BDGH	66-67	MV055	77-78
12THMEJ	17	3.6ADFH	64-65	7.2BFGH	66-67	MV155	80-81
12TKLEJ	17	3.6ADGH	64-65	7.2CAV	47	SB**	93-94
12TXLEJ	17	3.6ADLSJ	14	7.2OBCN	39	SBR**	93-94
15.5ABFN	41	3.6ADOSJ	14	7.2OBWN	39	SD**	93-94
15.5BDGH	70	3.6CAV2	45	7.2OEFM	57	SU**	93-94
15.5BFGH	70	3.6OEFM	56	7.2OHGM	57	TB**	93-94
15.5CAV	49 & 85	3.6OEGM	56	7.2DLSJ	15	TBR**	93-94
15.5FFVH	80-81	3.6OLGM	56	7.2TFLSJ	15	TD**	93-94
15.5BFN	41	3.6WDFH	26-27	7.2WFMSJ	31	TU**	93-94
15.5OEFM	59	3.6WDLSJ	30	7.2WFNH	28	XAB**	93-94
15.5OHGM	59	3.6WDOH	26-27	7.2WKMSJ	31	XABR**	93-94
15.5OLGM	59	3.6WDOSJ	14 & 30*	7.2WKNH	28	XAD**	93-94
155GXQJSJ	75	3.6WFFH	26-27	72.5AFKH	73	XAU**	93-94
17.5ABGN	42	3.6WFGH	26-27	8.25BFNH	79		
17.5AILSJ	18-19	3.6WFLSJ	30	8.25FFNH	79		
17.5CAV	50	3.6WFOH	26-27	A3354705	92		
17.5OBGN	42	3.6WFOSJ	14 & 30*	A3354710	92		
17.5OHGM	60	3.6WJON	26-27	A3354720	92		
17.5TDLSJ	18-19	3.6WKFGH	26-27	A3354730	92		
17.5TDMEJ	18-19	3.6WKFH	26-27	A3354745	92		
17.5TFLSJ	18-19	3.6WKGH	26-27	ASL	95-98		
17.5THMEJ	18-19	3.6WKLSJ	30	BBU	99-105		
17.5TKMEJ	18-19	36ADIH	72	ECL055	86		
175GDMSJ	75-76	36AFIH	72	ECL083	87		
175GFMSJ	75-76	36AFKH	72	ECL155	88		
175GX	75-76	36CAV	52	JCD	84		
2.75VFRH	32	36OBGN	44	JCE	84		
2.75VKRH	32	36TDQJSJ	22	JCG	89-91		

* Page 14: DIN Fuse link, Page 30 DIN motor fuse link

** Expulsion fuse links

At Eaton, we're energized by the challenge of powering a world that demands more. With over 100 years experience in electrical power management, we have the expertise to see beyond today. From groundbreaking products to turnkey design and engineering services, critical industries around the globe count on Eaton.

We power businesses with reliable, efficient and safe electrical power management solutions. Combined with our personal service, support and bold thinking, we are answering tomorrow's needs today. Follow the charge with Eaton. Visit eaton.com/electrical.

Contact your local Eaton office

Electrical Sector
Eaton's Bussmann business
Melton Road
Burton-on-the-Wolds
LE12 5TH
Leicestershire
United Kingdom
bulesales@eaton.com
www.bussmann.com

Eaton Industries Manufacturing GmbH
Electrical Sector EMEA
Route de la Longeraie
71110 Morges, Switzerland
Eaton.eu

© 2014 Eaton
All Rights Reserved
Printed in the United Kingdom
Publication No. CA132003EN
June 2014

Changes to the products, to the information contained in this document, and to prices are reserved; so are errors and omissions. Only order confirmations and technical documentation by Eaton is binding. Photos and pictures also do not warrant a specific layout or functionality. Their use in whatever form is subject to prior approval by Eaton. The same applies to Trademarks (especially Eaton, Moeller, and Cutler-Hammer). The Terms and Conditions of Eaton apply, as referenced on Eaton Internet pages and Eaton order confirmations.

Eaton is a registered trademark.

All other trademarks are property of their respective owners.

Follow us on social media to get the latest product and support information.

