



GE Power Controls

HRC Fuse Links

Low Voltage Industrial

RED SPOT / SAFECLIP / 'NH'

RED SPOT Standard



RED SPOT 400 Series



SAFECLIP



'NH' DIN Standard



RED SPOT / SAFECLIP / 'NH'



Low Voltage Industrial HRC Fuse Links

Contents

RED SPOT Standard **A**

RED SPOT 400 Series **B**

SAFECLIP **C**

'NH' DIN Standard **D**

Comparative Charts **E**



For all applications



With one of the most extensive ranges available and an unsurpassed reputation for quality and reliability, RED SPOT® and SAFECLIP® Fuse Links can truly offer solutions for all industrial applications.

Combine this with experience in the manufacture and application of High Rupturing Capacity (HRC) Fuse Links that can be traced back for over half a century through GEC Alstom and English Electric and it is easy to understand why the expertise available to GE Power Controls is recognised world-wide.

This expertise has been applied to further develop these well respected products using the latest technologies to ensure the range meets the demanding circuit protection requirements of modern installations.

In the field of motor protection comprehensive testing has been undertaken to achieve first Type C and now Type 2 co-ordination when RED SPOT® Standard Fuse Links are used with GE Power Controls motor control products plus other leading manufacturers.

Whatever your HRC Fuse Links industrial application requirements the resources of GE Power Controls are available to provide the best technical and economic solution. With RED SPOT® and SAFECLIP® you can depend on the best.

Please consult GE Power Controls Ltd for advice on applications not covered in this publication.



Low Voltage Industrial HRC Fuse Links

Utilities



RED SPOT Standard

Bolted Tag up to 660Vac
up to 1250A



RED SPOT 400 Series

Bolted Tag up to 440Vac
up to 400A



SAFECLIP

Blade Tag up to 440Vac
up to 125A



'NH' DIN Standard

Knife Blade up to 500Vac
up to 630A



HRC Fuse Links for other applications

- Protection of Semiconductor Devices (BS88/IEC & DIN)
- House Service and Street Lighting Cut-outs
- Electricity Supply Distribution
- High Voltage Fuse Links up to 34.5kV
- Railway Signalling, Traction and DC Applications
- Admiralty, Aircraft and Interservice Pattern
- Canadian (CSA) and North American Spec.
- Details available on request**



RED SPOT 400



GE Power Controls
NH DIN







Contents

RED SPOT Standard **A**

- A. 2 Product introduction
- A. 3 – 5 Fuse Link selection list
- A. 6 Dimensions
- A. 7 – 8 Technical data

RED SPOT 400 Series **B**

SAFECLIP **C**

'NH' DIN Standard **D**

Comparative Charts **E**





Applications



Approvals

ASTA (20) Certified

Application Notes

Protection of PVC insulated cables

RED SPOT Standard Fuse Links will protect an associated cable against both overload and short circuit if its current rating is equal to or less than the current rating of the cable. This is in accordance with the IEE Wiring Regulations (BS 7671:1992).

Short circuit energy limitation

RED SPOT Standard Fuse Links limit the peak current and energy let through to circuits that experience short circuit faults. This enables significant economies to be made in the design of equipment used in combination with RED SPOT Fuse Links.

Discrimination

RED SPOT Standard Fuse Links will discriminate with each other at fault levels up to 80kA, at 415Vac, in most cases when the ratio between 'major' and 'minor' current ratings is 1.6:1.

Motor Starting Ability

All RED SPOT Standard Fuse Links are suitable for the protection of motor circuits and have superior withstand to motor starting surges. The dual rated types for motor circuit protection enhance this withstand capability.

Motor Circuit Protection

RED SPOT Standard Fuse Links combined with GE Power Controls 'CL' and 'CK' range of contactors and 'RT' thermal overload relays, provide certified Type 2 co-ordination in line with the latest International Standards (IEC 947-4-1).

Protection against electric shock

RED SPOT Standard Fuse Links protect against electric shock when used in accordance with the IEE Wiring Regulations (BS 7671:1992).

Power dissipation

All RED SPOT Standard Fuse Links have low power loss values, well within the limits specified in BS 88:Part2: (IEC 269-2).

HRC Fuse Links

RED SPOT Standard

BS 88-2:1988

IEC 269-2

Technical Data

Current Rating	(A) 2-1250
Voltage Rating ac	(V) up to 660
Voltage Rating dc	(V) up to 460
Breaking Capacity ac	(kA) 80
Breaking Capacity dc	(kA) 40
Max Operating Ambient Temperature	(°C) 40

Breaking Capacity

AC Performance

ASTA 20 certified to 80kA, generally at 660 Volts, to BS 88: Part 2: 1988 (IEC 269-2).

DC Performance

ASTA certified at 40kA, to BS 88:Part 2: 1988 (IEC 269-2).

Associated Fusegear Equipment

- RED SPOT Fuse Holders
- RED SPOT Fusebanks
- RED SPOT Fuseboards

Associated Switchable Devices

- CM Cubicle Mounting Fuse Switches
- FULOS Fused Disconnecter Loadbreak Switches
- MST Panel Mounting Fuse Switches
- WM Wall Mounting Fuse Switches

- Contact the sales office for catalogues

RED SPOT Standard - Offset tags: 2-hole fixing



BS Ref. A1
Fixing Centres
44.5mm

Current rating	Part number	Code	Max voltage rating ac	Max voltage rating dc
2A	NIT2	401230	550	250
4A	NIT4	401231	550	250
6A	NIT6	401232	550	250
10A	NIT10	401225	550	250
16A	NIT16	401226	550	250
20A	NIT20	401227	550	250
20M25A	NIT20M25	401228	440	250
20M32A	NIT20M32	401229	440	250
25A	NET25	401220	440	250
32A	NET32	401221	440	250
32M40A	NET32M40	401222	440	250
32M50A	NET32M50	401223	440	250
32M63A	NET32M63	401224	440	250



BS Ref. A2
Fixing Centres
73mm

2A	TIA2	400295	660	460
4A	TIA4	400301	660	460
6A	TIA6	400302	660	460
10A	TIA10	400291	660	460
16A	TIA16	400292	660	460
20A	TIA20	400293	660	460
25A	TIA25	400294	660	460
32A	TIA32	400296	660	460
32M35A	TIA32M35	400297	660	460
32M40A	TIA32M40	400298	660	460
32M50A	TIA32M50	400299	660	460
32M63A	TIA32M63	400300	660	460



BS Ref. A3
Fixing Centres
73mm

35A	TIS35	400303	660	460
40A	TIS40	400305	660	460
50A	TIS50	400306	660	460
63A	TIS63	400307	660	460
63M80A	TIS63M80	400310	660	460
63M100A	TIS63M100	400309	660	460



BS Ref. A4
Fixing Centres
93.7mm

32A	TCP32	400277	660	460
40A	TCP40	400278	660	460
50A	TCP50	400279	660	460
63A	TCP63	400280	660	460
80A	TCP80	400281	660	350
100A	TCP100	400273	660	350
100M125A	TCP100M125	400274	660	350
100M160A	TCP100M160	400275	660	350
100M200A	TCP100M200	400276	660	350



Fixing Centres
93.7mm

125A	TFP125	400287	660	350
160A	TFP160	400288	660	350
200A	TFP200	400289	660	350
200M250A	TFP200M250	400290	660	350

RED SPOT Standard - Central tags: 2-hole fixing

RED SPOT Standard

A



BS Ref. B1
Fixing Centres
111mm

Current rating	Part number	Code	Max voltage rating ac	Max voltage rating dc
80A	TC80	400272	660	350
100A	TC100	400268	660	350
100M125A	TC100M125	400269	660	350
100M160A	TC100M160	400270	660	350
100M200A	TC100M200	400271	660	350



BS Ref. B2
Fixing Centres
111mm

125A	TF125	400282	660	350
160A	TF160	400283	660	350
200A	TF200	400284	660	350
200M250A	TF200M250	400285	660	460
200M315A	TF200M315	400286	550	



BS Ref. B3
Fixing Centres
111mm

250A	TKF250	400311	660	460
315A	TKF315	400312	660	460
315M355A	TKF315M355	400313	660	460



Fixing Centres
133mm

250A	TKM250	400314	660	460
315A	TKM315	400315	660	460
315M355A	TKM315M355	400316	660	460



BS Ref. B4
Fixing Centres
111mm

355A	TMF355	400334	660	460
400A	TMF400	400335	660	460
400M450A	TMF400M450	400336	660	460

RED SPOT Standard - Central tags: 4-hole fixing



BS Ref. C1
Fixing Centres
133mm

Current rating	Part number	Code	Max voltage rating ac	Max voltage rating dc
355A	TM355	400331	660	460
400A	TM400	400332	660	460
400M450A	TM400M450	400333	660	460



BS Ref. C2
Fixing Centres
133mm

450A	TTM450	400344	660	450
500A	TTM500	400345	660	450
560A	TTM560	400346	660	450
630A	TTM630	400347	660	450
630M670A	TTM630M670	400348	660	450



BS Ref. C3
Fixing Centres
133mm

670A	TLM670	400317	660	350
710A	TLM710	400318	660	350
750A	TLM750	400319	660	350
800A	TLM800	400320	660	350



BS Ref. D1
Fixing Centres
149mm

1000A	TXU1000	400356	660	300
1250A	TXU1250	400357	660	300

RED SPOT Standard - Additional ranges

Range	Current rating	Fixing centres	Max voltage rating ac	Max voltage rating dc
Central tags: 2-hole fixing				
TB	2 - 63 A	97mm	660	460
TBC	2 - 63 A	111mm	660	460
Central tags: 4-hole fixing				
TMT	355 & 400 A	165mm	660	460
TT	450 - 630 A	165mm	660	450
TLT	670 - 800 A	165mm	660	350
TLU	560 - 800 A	149mm	660	350

TZC, TZCP, TZF, and TZLM Fuse Links proved at 460 Volt dc are available for users who need superior dc performance in these dimensional references.
Fuse Links for Canada complying with CSA Specification C22-2 No 106-M92 are also available.



Dimensions in mm

RED SPOT Standard - Offset tags: 2-hole fixing

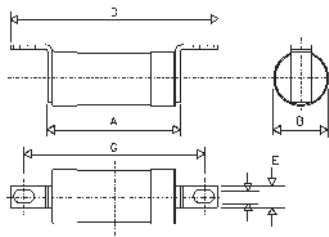

Type	Rating	A	B	D	E	G Fixing Centres	H
NIT	2 - 20M32	36.50	14.10	55.60	11.10	44.50	4.70
NET	25 - 32M40	36.50	14.10	55.60	11.10	44.50	4.70
	32M50, M63	37.70	17.50	55.10	11.10	44.50	4.70
TIA	2 - 32M63	56.40	22.20	85.80	8.70	73.00	5.20
TIS	35 - 63	56.40	22.20	85.80	8.70	73.00	5.20
	63M80, M100	58.00	26.00	90.50	12.70	73.00	5.20
TCP	32 - 63	56.00	22.20	109.00	19.10	93.70	8.70
	80, 100	58.00	26.00	111.00	19.10	93.70	8.70
	100M125 - M200	70.00	33.70	111.00	19.10	93.70	8.70
TFP	125 - 200	70.00	33.70	111.00	19.10	93.70	8.70
	200M250	70.00	40.00	111.00	19.10	93.70	8.70

RED SPOT Standard - Central tags: 2-hole fixing

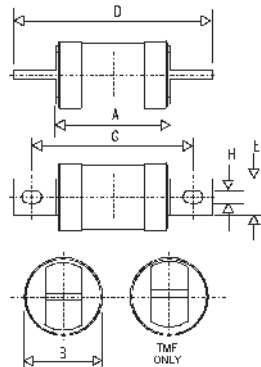

Type	Rating	A	B	D	E	G Fixing Centres	H
TC	80, 100	58.00	26.00	136.50	19.10	111.00	8.70
	100M125 - M200	70.00	33.70	136.50	19.10	111.00	8.70
TF	125 - 200	70.00	33.70	136.50	19.10	111.00	8.70
	200M250, M315	77.00	40.00	136.50	19.10	111.00	8.70
TKF	250	77.00	40.00	136.50	19.10	111.00	8.70
	315, 315M355	77.00	52.60	136.50	25.40	111.00	8.70
TKM	250 - 315M355	77.00	52.60	160.20	25.40	133.40	10.30
TMF	355 - 400M450	83.00	60.00	136.50	25.40	111.00	8.70

RED SPOT Standard - Central tags: 4-hole fixing

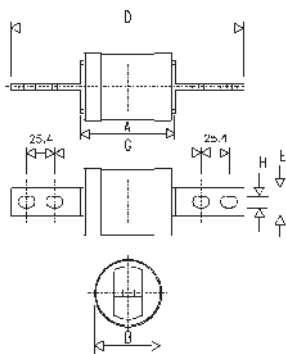

Type	Rating	A	B	D	E	G Fixing Centres	H
TM	355 - 400M450	83.00	60.00	211.00	25.40	133.00	10.30
TTM	450 - 630M670	81.80	74.20	209.60	25.40	133.00	10.30
TLM	670 - 800	88.10	82.20	209.60	25.40	133.00	10.30

RED SPOT Standard - Central tags: 4-hole fixing

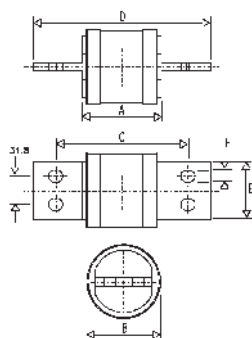

Type	Rating	A	B	D	E	G Fixing Centres	H
TXU	1000, 1250	88.90	99.50	200.00	63.50	149.00	13.50

RED SPOT Standard: I²t values

NIT and NET 2 Amp - 32 Amp

Current Rating (Amp)	Pre-Arcing I ² t (A ² sec)	Total I ² t (A ² sec) at 415 Volt	Total I ² t (A ² sec) at 440 Volt	Total I ² t (A ² sec) at 550 Volt
2	2.2	9.5	10	15
4	7.2	30	33	50
6	22	92	100	150
10	170	650	700	1000
16	200	800	950	1350
20	360	1200	1500	2200
25 & 20M25	650	2500	2900	
32 & 20M32	600	3500	4050	
32M40	2400	10100	12000	
32M50	3200	13500	15000	
32M63	5400	22500	25000	

2 Amp - 63 Amp

Current Rating (Amp)	Pre-Arcing I ² t (A ² sec)	Total I ² t (A ² sec) at 415 Volt	Total I ² t (A ² sec) at 550 Volt	Total I ² t (A ² sec) at 660 Volt
2	2	7	11	15
4	7	24	35	50
6	22	73	110	150
10	170	500	720	1000
16	150	560	790	1100
20	300	930	1270	1670
25	500	1730	2500	3400
32	1080	3200	4500	5900
35 & 32M35	1380	4100	5200	6500
40 & 32M40	1920	5200	5750	8380
50 & 32M50	3410	8000	10100	13260
63 & 32M63	6500	17000	21000	25000

RED SPOT Standard: Time/current characteristics

NIT and NET 2 Amp - 32 Amp

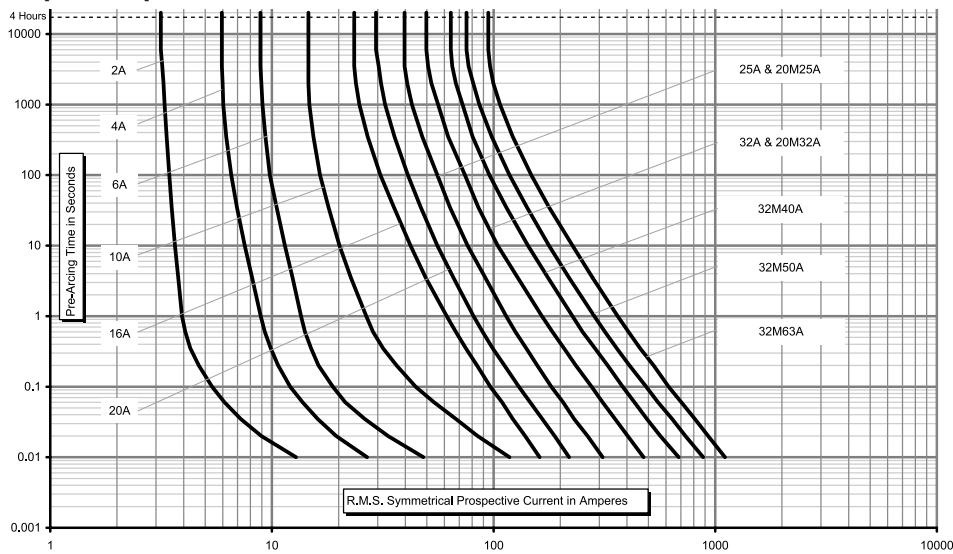

2 Amp - 63 Amp

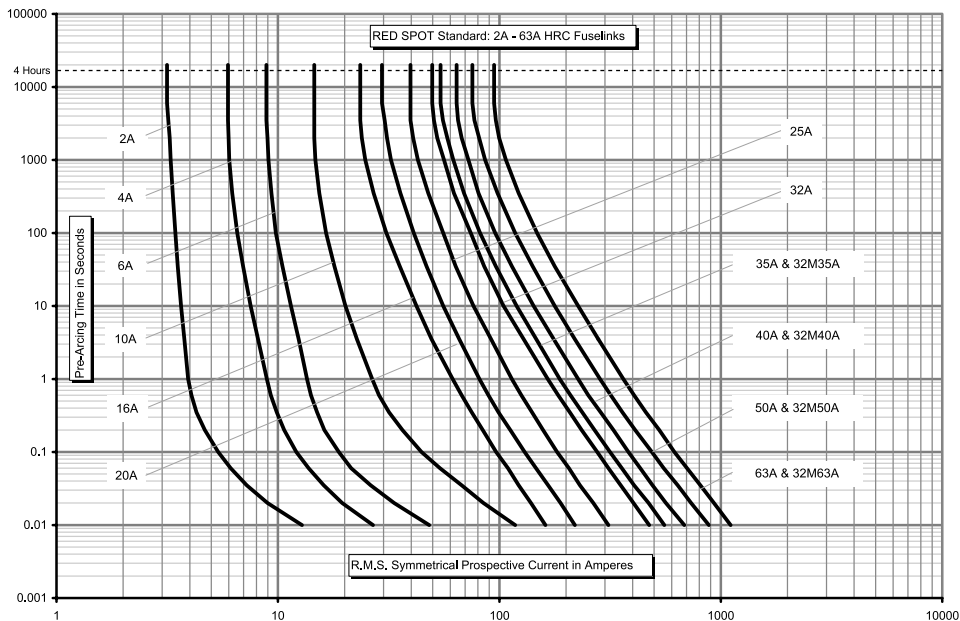

RED SPOT Standard: I²t values

80 Amp - 450 Amp

Current Rating (Amp)	Pre-Arcing I ² t (A ² sec x 10 ³)	Total I ² t (A ² sec x 10 ³) at 415 Volt	Total I ² t (A ² sec x 10 ³) at 550 Volt	Total I ² t (A ² sec x 10 ³) at 660 Volt
80 & 63M80	14	40	52	66
100 & 63M100	17	60	80	100
125 & 100M125	25	85	110	140
160 & 100M160	62	160	210	270
200 & 100M200	105	260	330	430
250 & 200M250	200	550	700	870
315 & 200M315*	300	800	1050	1350
355 & 315M355	500	1400	1850	2250
400	640	1800	2500	3000
450 & 400M450	800	2600	3000	3800

* Maximum rating of 200M315 is 550 Volt.

500 Amp - 1250 Amp

Current Rating (Amp)	Pre-Arcing I ² t (A ² sec x 10 ³)	Total I ² t (A ² sec x 10 ³) at 415 Volt	Total I ² t (A ² sec x 10 ³) at 550 Volt	Total I ² t (A ² sec x 10 ³) at 660 Volt
500	1050	3000	3800	4500
560	1400	3800	4250	5400
630	2000	5200	6000	7500
670 & 630M670	2400	6400	7400	9000
710	2800	7000	8100	9700
750	3700	8700	10500	12000
800	4400	11000	12000	15000
1000	5300	12500	15000	17500
1250	10000	21000	24000	29000

RED SPOT Standard: Time/current characteristics

80 Amp - 450 Amp

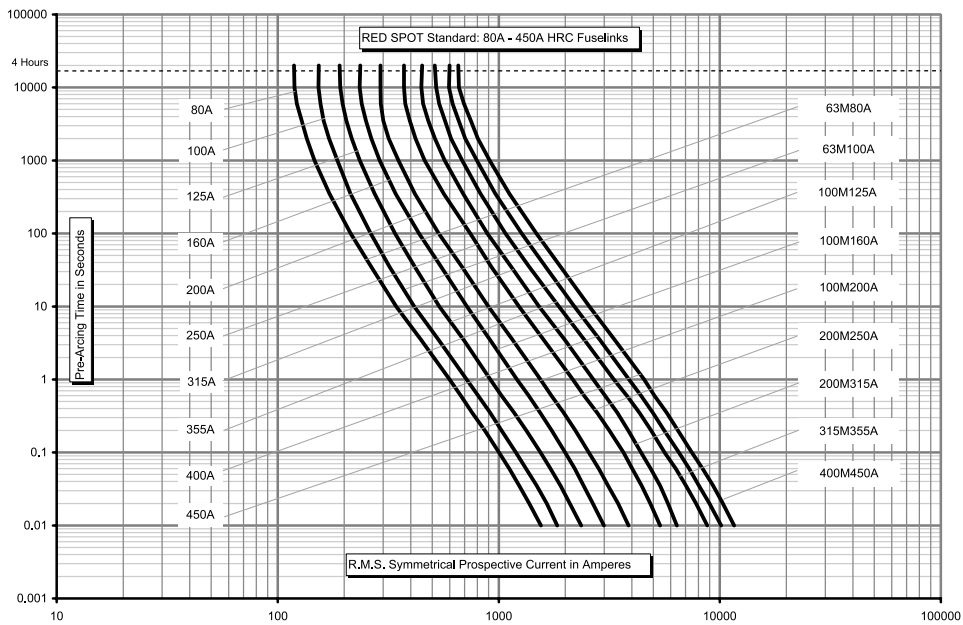

500 Amp - 1250 Amp

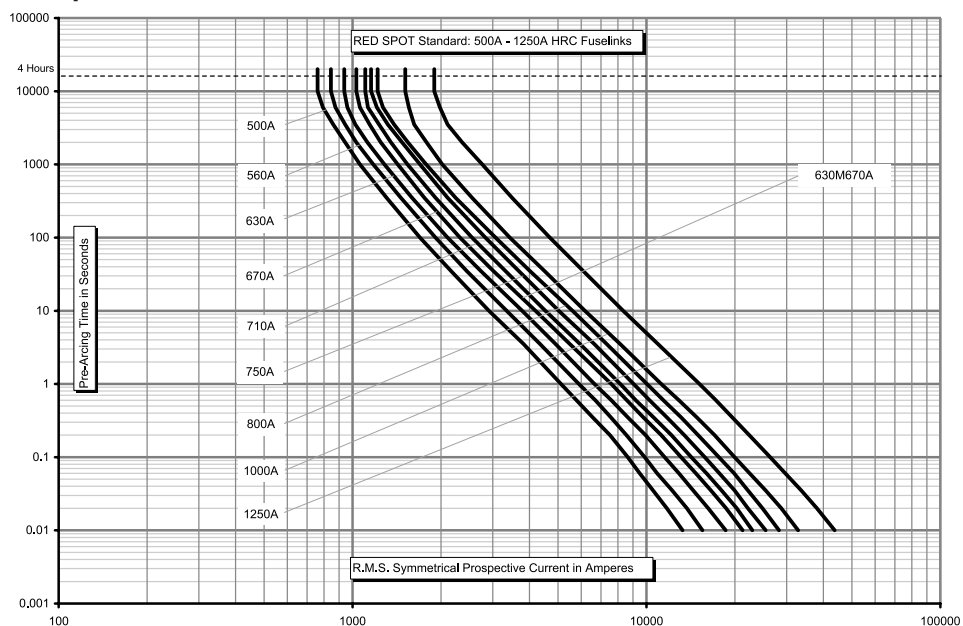

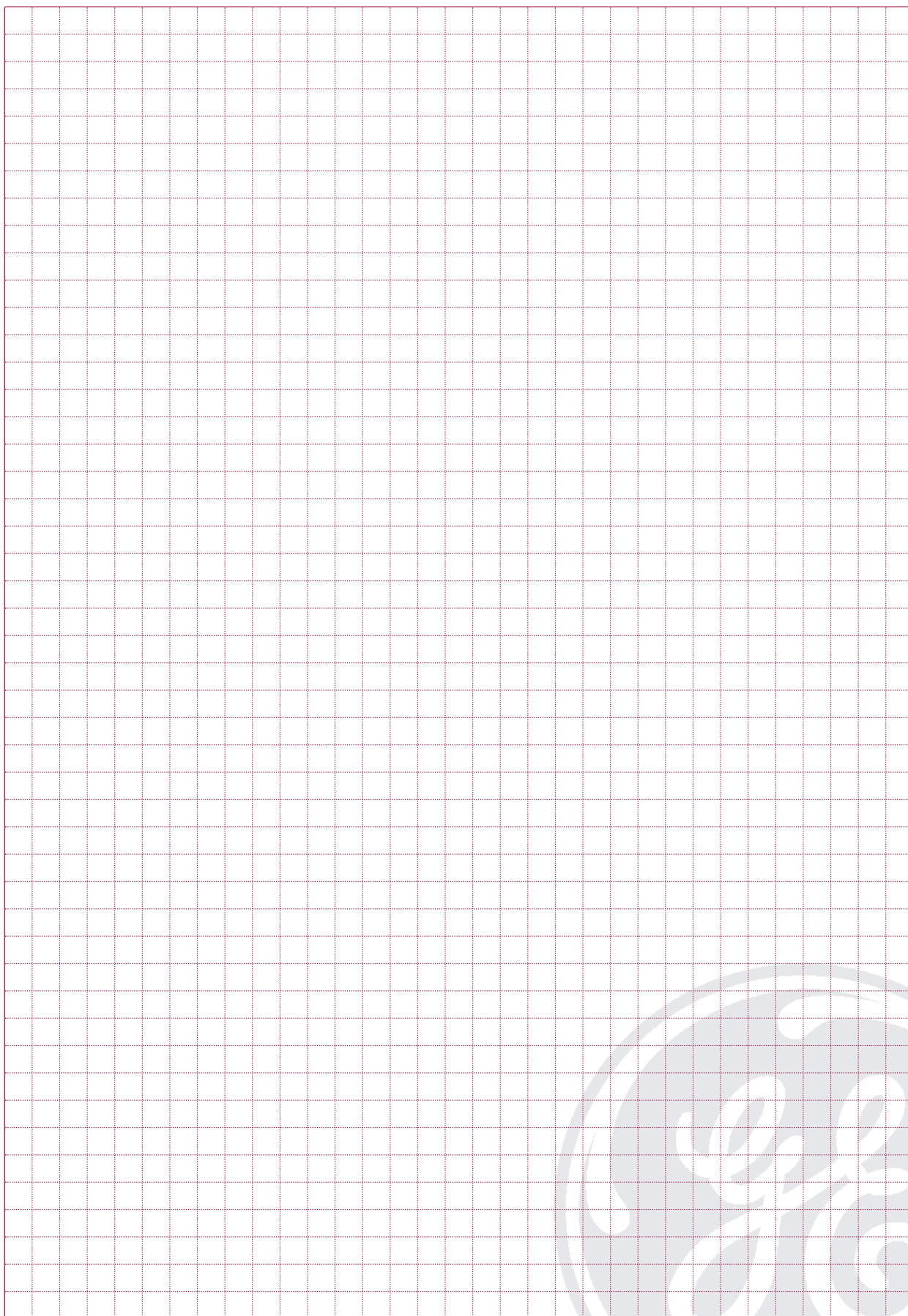





Contents

RED SPOT Standard A

RED SPOT 400 Series B

- B. 2 Product introduction
- B. 3 – 4 Fuse Link selection list
- B. 5 Dimensions
- B. 6 Technical data

SAFECLIP C

'NH' DIN Standard D

Comparative Charts E





Applications



Approvals

ASTA (20) Certified

Application Notes

Protection of PVC insulated cables

RED SPOT 400 Series Fuse Links will protect an associated cable against both overload and short circuit if its current rating is equal to or less than the current rating of the cable. This is in accordance with the IEE Wiring Regulations (BS 7671:1992).

Short circuit energy limitation

RED SPOT 400 Series Fuse Links limit the peak current and energy let through to circuits that experience short circuit faults. This enables significant economies to be made in the design of equipment used in combination with RED SPOT Fuse Links.

Discrimination

RED SPOT 400 Series Fuse Links will discriminate with each other at fault levels up to 80kA, at 415 Vac, in most cases when the ratio between 'major' and 'minor' current ratings is 1.6:1.

Motor Starting Ability

All RED SPOT 400 Series Fuse Links are suitable for the protection of motor circuits and have superior withstand to motor starting surges.

Motor Circuit Protection

RED SPOT 400 Series Fuse Links provide back up protection, including Type 2 co-ordination with the motor starter and associated cables.

Protection against electric shock

RED SPOT 400 Series Fuse Links protect against electric shock when used in accordance with the IEE Wiring Regulations (BS 7671:1992).

Power dissipation

All RED SPOT 400 Series Fuse Links have low power loss values, well within the limits specified in BS 88:Part2: (IEC 269-2).

HRC Fuse Links

RED SPOT 400 Series Compact

BS 88-2:1988

IEC 269-2

Technical Data

Current Rating	(A) 2-400
Voltage Rating ac	(V) up to 440
Breaking Capacity ac	(kA) 80*
Max Operating Ambient Temperature	(°C) 40

* also tested at 200kA

Breaking Capacity

AC Performance

ASTA 20 certified to 80kA, generally at 440 Volt, to BS 88: Part 2: 1988 (IEC 269-2).

Associated Fusegear Equipment

- RED SPOT Fuse Holders
- RED SPOT Fusebanks
- RED SPOT Fuseboards

Associated Switchable Devices

- CM Cubicle Mounting Fuse Switches
- FULOS Fused Disconnecter Loadbreak Switches
- MST Panel Mounting Fuse Switches
- WM Wall Mounting Fuse Switches

- Contact the sales office for catalogues



RED SPOT 400 Series - Offset tags: 2-hole fixing



BS Ref. A1
Fixing Centres
44.5mm

Current rating	Part number	Code	Max voltage rating ac
2A	GNIT2	401286	440
4A	GNIT4	401288	440
6A	GNIT6	401289	440
10A	GNIT10	401284	440
16A	GNIT16	401285	440
20A	GNIT20	401287	440



BS Ref. A2
Fixing Centres
73mm

Current rating	Part number	Code	Max voltage rating ac
2A	GTIA2	400380	440
4A	GTIA4	400384	440
6A	GTIA6	400385	440
10A	GTIA10	400378	440
16A	GTIA16	400379	440
20A	GTIA20	400381	440
25A	GTIA25	400382	440
32A	GTIA32	400383	440



BS Ref. A3
Fixing Centres
73mm

Current rating	Part number	Code	Max voltage rating ac
35A	GTIS35	400386	440
40A	GTIS40	400387	440
50A	GTIS50	400388	440
63A	GTIS63	400389	440



BS Ref. A4
Fixing Centres
94mm

Current rating	Part number	Code	Max voltage rating ac
35A	GTCP35	400370	440
40A	GTCP40	400371	440
50A	GTCP50	400372	440
63A	GTCP63	400373	440
80A	GTCP80	400374	440
100A	GTCP100	400369	440



Fixing Centres
94mm

Current rating	Part number	Code	Max voltage rating ac
125A	GTFF125	402760	440
160A	GTFF160	402761	440
200A	GTFF200	402762	440



RED SPOT 400 Series - Central tags: 2-hole fixing



BS Ref. B2
Fixing Centres
111mm

Current rating	Part number	Code	Max voltage rating ac
125A	GTF125	400375	440
160A	GTF160	400376	440
200A	GTF200	400377	440



BS Ref. B3
Fixing Centres
111mm

250A	GTKF250	400390	415
315A	GTKF315	400391	415



Fixing Centres
133mm

250A	GTKM250	402763	415
315A	GTKM315	402764	415



BS Ref. B4
Fixing Centres
111mm

355A	GTMF355	400394	415
400A	GTMF400	400395	415

RED SPOT 400 Series - Central tags: 4-hole fixing



BS Ref. C1
Fixing Centres
133mm

Current rating	Part number	Code	Max voltage rating ac
355A	GTM355	400392	415
400A	GTM400	400393	415

RED SPOT 400 Series

B



Dimensions in mm

RED SPOT 400 Series - Offset tags: 2-hole fixing

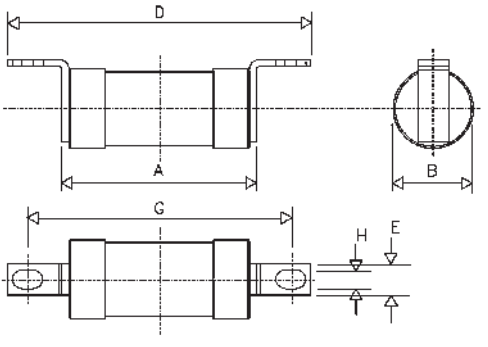

Type	Rating	A	B	D	E	G Fixing Centres	H
GNIT	2 - 20	34.10	14.10	55.60	11.10	44.50	4.70
GTIA	2 - 32	35.00	14.10	83.30	8.60	73.00	5.20
GTIS	35 - 63	54.00	22.20	83.90	8.60	73.00	5.20
GTCP	35 - 100	56.40	22.20	109.00	19.10	94.00	8.60
GTFP	125 - 200	45.40	34.00	111.50	19.10	94.00	8.70

RED SPOT 400 Series - Central tags: 2-hole fixing

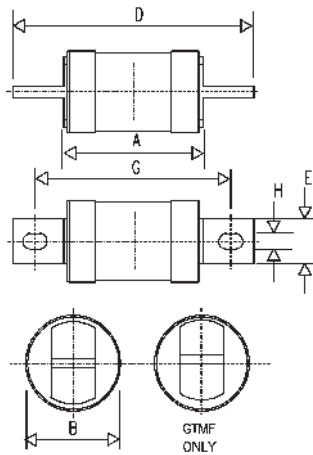

Type	Rating	A	B	D	E	G Fixing Centres	H
GTF	125 - 200	47.00	34.00	134.50	19.10	111.00	8.70
GTKF	250, 315	47.00	34.00	134.50	19.10	111.00	8.70
GTKM	250, 315	47.00	34.00	166.00	19.10	133.00	11.00
GTMF	355, 400	50.20	40.40	134.50	25.40	111.00	8.70

RED SPOT 400 Series - Central tags: 4-hole fixing

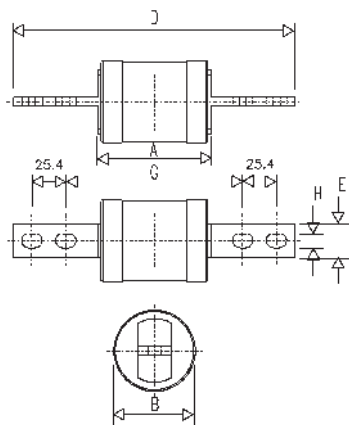

Type	Rating	A	B	D	E	G Fixing Centres	H
GTM	355, 400	50.20	40.40	211.00	25.40	133.00	11.00





RED SPOT 400 Series: I^2t values

2 Amp - 100 Amp

Current Rating (Amp)	Pre-Arcing I^2t (A ² sec)	Total I^2t (A ² sec) at 415 Volt	Total I^2t (A ² sec) at 440 Volt
2	2	10	11
4	10	20	23
6	21	60	65
10	130	350	380
16	200	690	760
20	360	1270	1400
25	670	2650	2900
32	700	3600	4000
35	1800	5500	6000
40	1900	6400	7000
50	4400	10000	11000
63	7700	18000	20000
80	17000	39000	43000
100	30000	62000	68000

125 Amp - 400 Amp

Current Rating (Amp)	Pre-Arcing I^2t (A ² sec x 10 ³)	Total I^2t (A ² sec x 10 ³) at 415 Volt	Total I^2t (A ² sec x 10 ³) at 440 Volt
125	30	75	83
160	60	155	165
200	120	315	335
250	180	420	
315	270	660	
355	330	750	
400	520	1200	

RED SPOT 400 Series: Time/current characteristics

2 Amp - 100 Amp

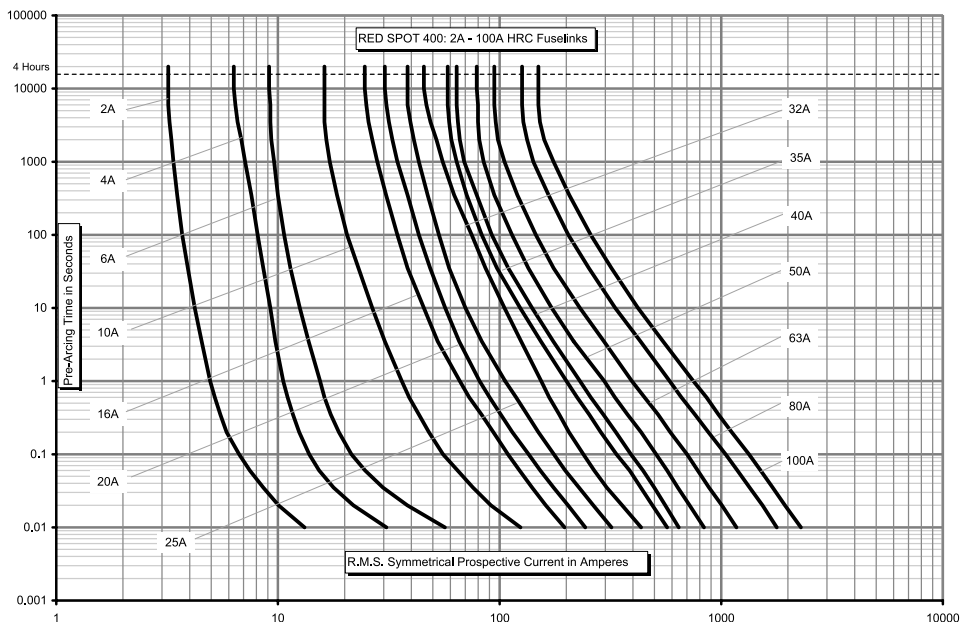

125 Amp - 400 Amp

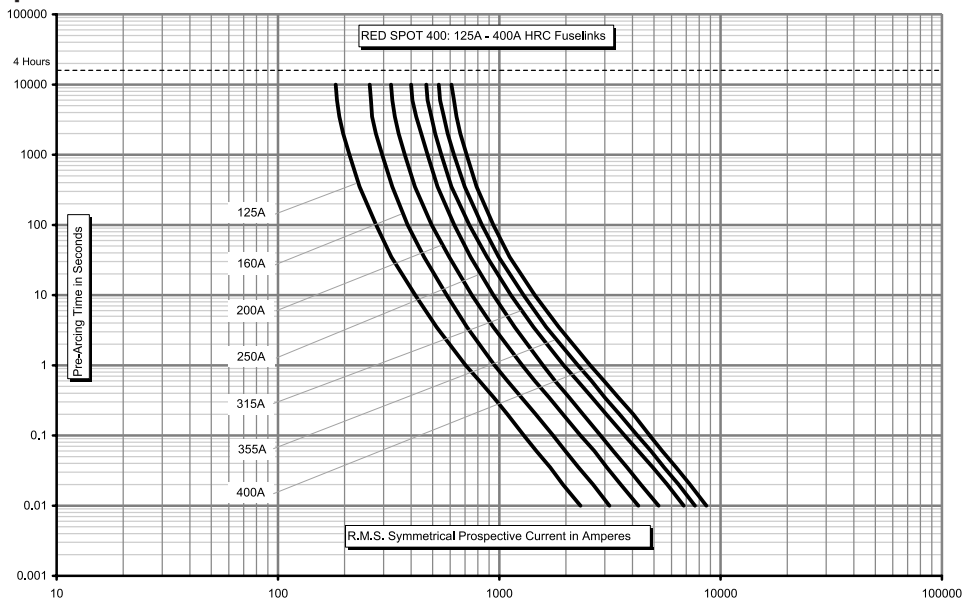

A large grid of graph paper for taking notes, consisting of a 20x30 grid of small squares. The grid is mostly empty, with a faint GE logo watermark visible in the bottom right corner.



Contents

RED SPOT Standard A

RED SPOT 400 Series B

SAFECLIP C

- C. 2 Product introduction
- C. 3 Fuse Link selection list
- C. 4 Dimensions
- C. 5 – 6 Technical data

'NH' DIN Standard D

Comparative Charts E





Applications



Approvals

ASTA (20) Certified

Application Notes

Protection of PVC insulated cables

SAFECLIP Fuse Links will protect an associated cable against both overload and short circuit if its current rating is equal to or less than the current rating of the cable. This is in accordance with the IEE Wiring Regulations (BS 7671:1992).

Short circuit energy limitation

SAFECLIP Fuse Links limit the peak current and energy let through to circuits that experience short circuit faults. This enables significant economies to be made in the design of equipment used in combination with SAFECLIP Fuse Links.

Discrimination

SAFECLIP Fuse Links will discriminate with each other at fault levels up to their rated ac performance in most cases when the ratio between 'major' and 'minor' current ratings is 2:1.

Motor Starting Ability

All SAFECLIP Fuse Links are suitable for the protection of motor circuits and have superior withstand to motor starting surges.

Protection against electric shock

SAFECLIP Fuse Links protect against electric shock when used in accordance with the IEE Wiring Regulations (BS 7671:1992).

Power dissipation

All SAFECLIP Fuse Links have low power loss values, well within the limits specified in BS 88: Part 2 (IEC 269-2).

HRC Fuse Links

SAFECLIP

BS 88-1 or 6:1988

IEC 269-1

Technical Data

Current Rating	(A) 2-125
Voltage Rating ac	(V) up to 440
Breaking Capacity ac	(kA) 80
Max Operating Ambient Temperature	(°C) 40

Breaking Capacity

AC Performance

The standard ratings are ASTA 20 certified to 80kA, 440 Volt*, to BS 88: Part 1 or Part 6: 1988 (IEC 269-1).

* SS types are certified at 16.5kA, 240 Volt, and the NS32M40, ES63M80 and XS125 at 80kA, 415 Volt.

Associated Fusegear Equipment

- SAFECLIP Fuse Holders
- SAFECLIP Fusebanks
- SAFECLIP Fuseboards

Associated Switchable Devices

- MSS Panel Mounting Fuse Switches
- WMSS Wall Mounting Fuse Combination Units
- MST100 Panel Mounting Fuse Switch
- WM1003N Wall Mounting Fuse Switch
- SAFECLIP Panel Boards

- Contact the sales office for catalogues

SAFECLIP - Offset blade tag: Type SS



BS Ref. E1

Current rating	Part number	Code	Max voltage rating ac
2A	SS2	401257	240
4A	SS4	401261	240
6A	SS6	401262	240
10A	SS10	401255	240
16A	SS16	401256	240
20A	SS20	401258	240

SAFECLIP - Offset blade tag: Type NS



BS Ref. F1

Current rating	Part number	Code	Max voltage rating ac
2A	NS2	401236	440
4A	NS4	401242	440
6A	NS6	401243	440
10A	NS10	401234	440
16A	NS16	401235	440
20A	NS20	401237	440
25A	NS25	401238	440
32A	NS32	401239	440
32M40A	NS32M40	401240	415

SAFECLIP - Offset blade tag: Type ES



BS Ref. F2

Current rating	Part number	Code	Max voltage rating ac
40A	ES40	401186	440
50A	ES50	401187	440
63A	ES63	401188	440
63M80A	ES63M80	401190	415

SAFECLIP - Offset blade tag: Type XS



Current rating	Part number	Code	Max voltage rating ac
2A	XS2	401273	440
4A	XS4	401278	440
6A	XS6	401281	440
10A	XS10	401269	440
16A	XS16	401272	440
20A	XS20	401274	440
25A	XS25	401275	440
32A	XS32	401276	440
35A	XS35	401277	440
40A	XS40	401279	440
50A	XS50	401280	440
63A	XS63	401282	440
80A	XS80	401283	440
100A	XS100	401270	440
125A	XS125	401271	415

SAFECLIP - Offset tags: 2-hole fixing: Type OS



Fixing Centres
73mm

Current rating	Part number	Code	Max voltage rating ac
80A	OS80	400234	440
100A	OS100	400231	440
100M125A	OS100M125	400232	415
100M160A	OS100M160	400233	415

Dimensions in mm

SAFECLIP - Offset blade tag

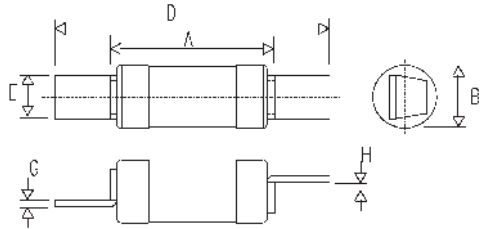

Type	Rating	A	B	D	E	G	H
SS	2 - 20	25.00	14.50	51.00	11.00	0.80	3.60
NS	2 - 32M40	35.50	14.50	62.00	11.00	0.80	3.60
ES	40 - 63M80	39.00	17.50	69.00	15.00	1.25	3.60
XS	2 - 125	39.00	26.40	80.00	19.00	1.60	3.60

SAFECLIP - Offset tags: 2-hole fixing

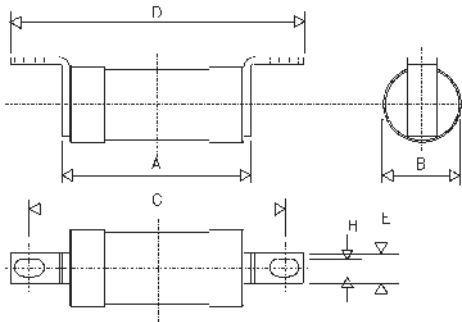

Type	Rating	A	B	D	E	G Fixing Centres	H
OS	80 - 100M160	58.00	26.40	90.50	12.70	73.00	5.20

SAFECLIP

C

SAFELIP: I²t values

Type SS

Current Rating (Amp)	Pre-Arcing I ² t (A ² sec)	Total I ² t (A ² sec) at 240 Volt
2	2	4
4	7.5	15
6	30	85
10	50	150
16	140	1400
20	300	1700

Type NS, ES and XS

Current Rating (Amp)	Pre-Arcing I ² t (A ² sec)	Total I ² t (A ² sec) at 415 Volt	Total I ² t (A ² sec) at 440 Volt
2	2.2	9.5	11
4	7.2	30	33
6	22	92	100
10	170	650	700
16	200	800	950
20	360	1200	1500
25	650	2500	2900
32	600	3500	4050
40 & 32M40*	2400	6400	12000
50	3200	11500	15000
63	5400	14500	25000
80 & 63M80*	6000	24000	38000
100	12000	54000	58000
125	13000	115000	

* Maximum rating of 32M40 and 63M80 is 415 Volt.

SAFELIP: Time/current characteristics

Type SS

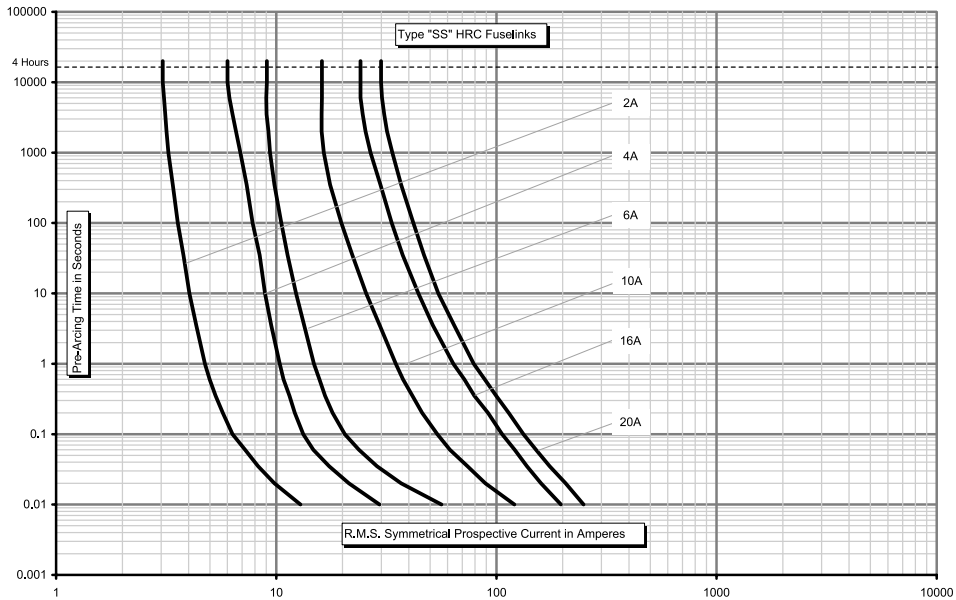

Type NS, ES and XS

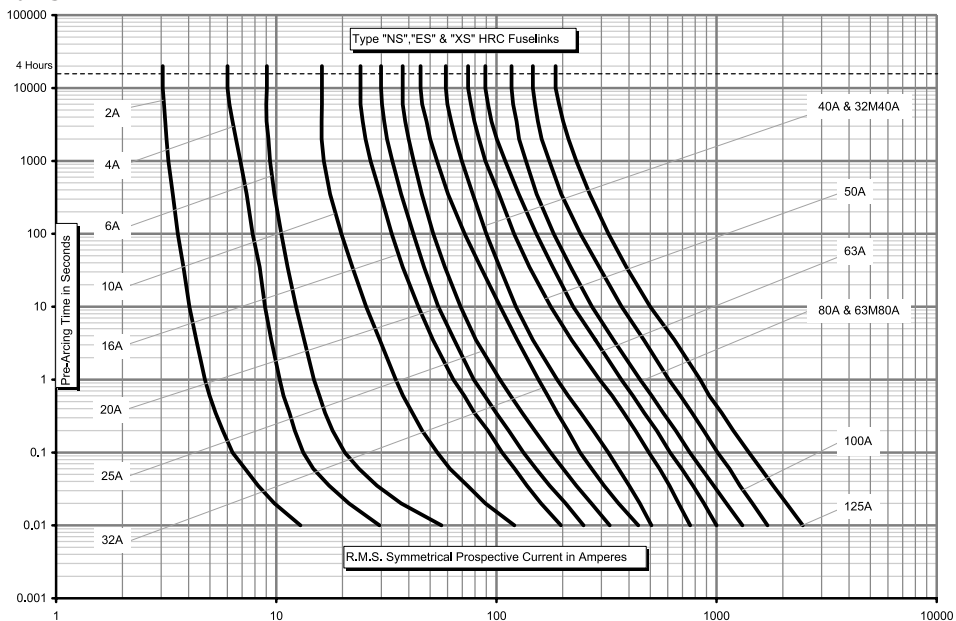

SAFECLIP: I²t values

Type OS

Current Rating (Amp)	Pre-Arcing I ² t (A ² sec)	Total I ² t (A ² sec) at 415 Volt	Total I ² t (A ² sec) at 440 Volt
80	14000	37000	40000
100	17000	57000	60000
100M125	32000	120000	
100M160	50000	135000	

SAFECLIP: Time/current characteristics

Type OS

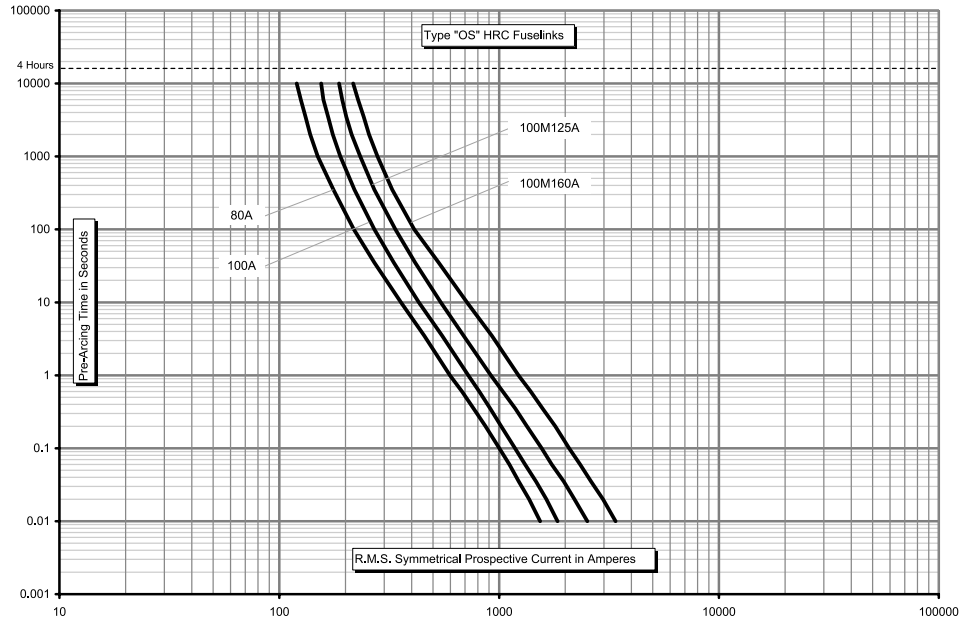

SAFECLIP

C



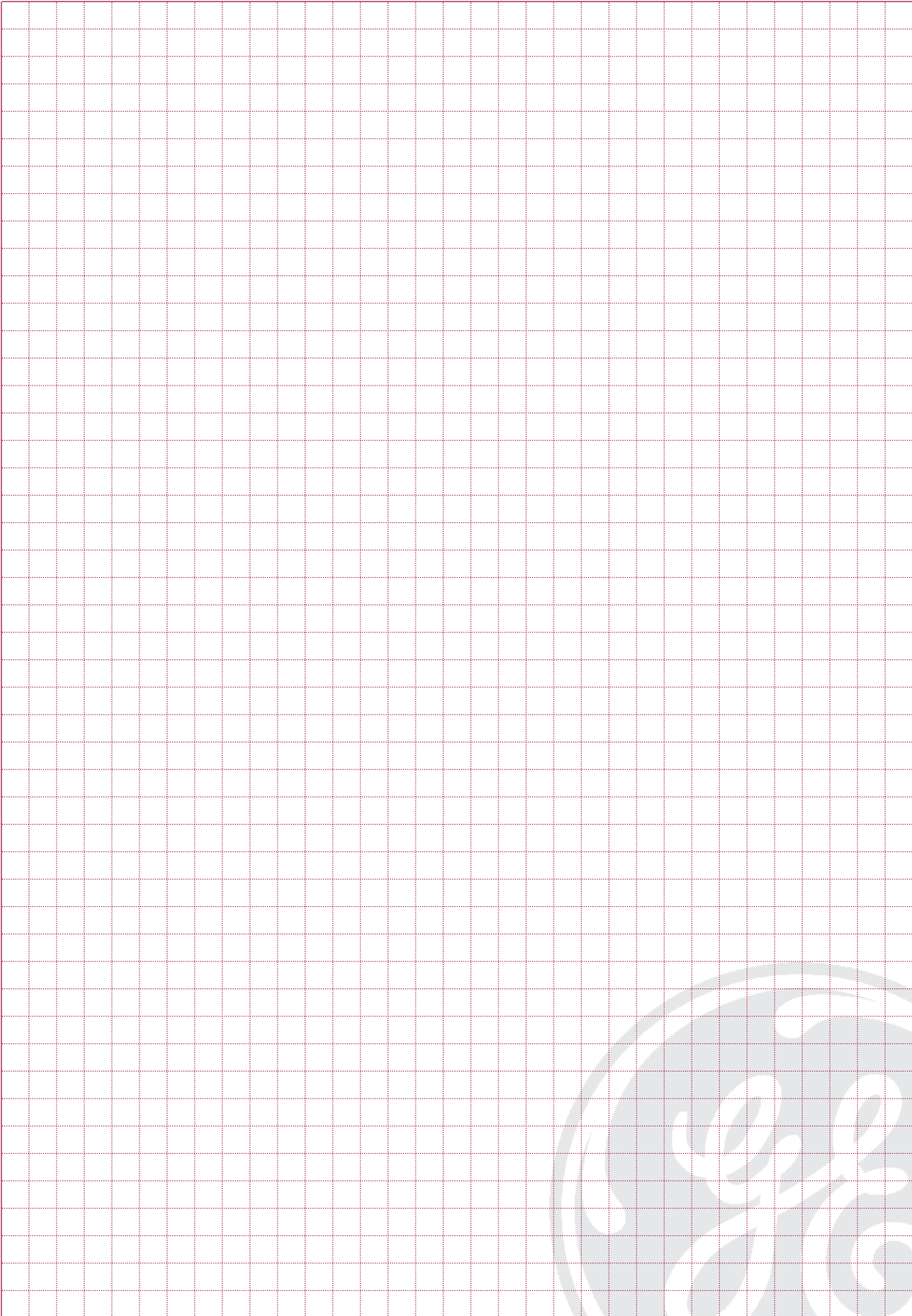

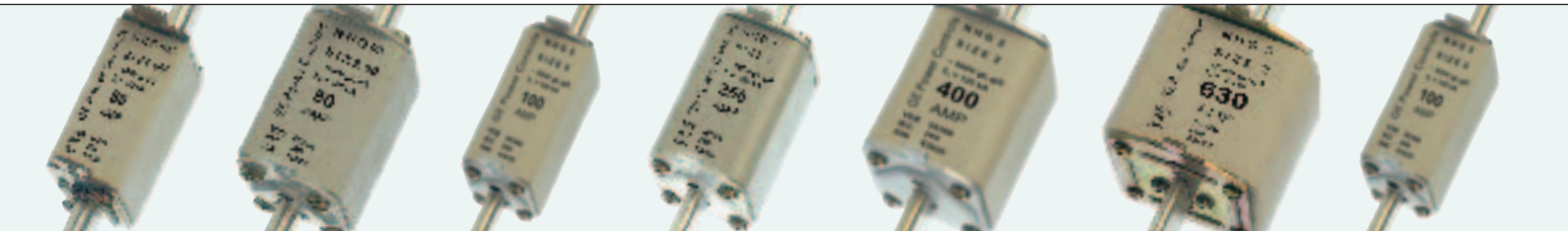

Contents

RED SPOT Standard A

RED SPOT 400 Series B

SAFECLIP C

'NH' DIN Standard D

- D. 2 Product introduction
- D. 3 – 4 Fuse Link selection list 'NHG' (General Purpose)
- D. 5 Fuse Link selection list 'NHA' (Motor Starting)
- D. 6 Dimensions
- D. 7 Technical data 'NHG' (General Purpose)
- D. 8 Technical data 'NHA' (Motor Starting)

Comparative Charts E





Applications



Approvals



Application Notes

'NHG' General Purpose

With European dimensional standards to DIN 43620 and performance standards to VDE 0636/21, operating class gL, 'NHG' range of Fuse Links are rated for use on systems up to 500 Volts ac

Technical Standard

VDE 0636/21 Class 'gL'

IEC 269-21 General purpose Fuse Links Class 'gG'

'NHA' Motor Starting

Class 'aM' range of DIN Fuse Links are specifically designed for the short circuit protection of equipment in motor circuits.

The Fuse Links are used in combination with overload protective devices ensuring total protection of the circuit.

The rating of the Fuse Link is selected against the nominal current of the motor. This enables simple and effective selection of Fuse Links for motor circuits.

Technical Standard

VDE 0636/22 Class 'aM'

IEC 269 Motor Starting Fuse Links Class 'gM'

Note:

All Fuse Links are supplied with plain undrilled knife-blade tags and with visual indicator situated in the top end plate.

HRC Fuse Links

'NHG' and 'NHA' DIN Standard

IEC 269

VDE 0636

Technical Data

Current Rating	(A) 6-630
Voltage Rating ac	(V) 500
Breaking Capacity ac	(kA) 120
Max Operating Ambient Temperature	(°C) 40

Breaking Capacity

AC Performance

'NH' Fuse Links are VDE certified at 120kA RMS, 50Hz, 500 Volt to IEC 269.

Associated Fusegear Equipment

- 'NH' Fuse Bases
- 'NH' Extractor Handle

Associated Switchable Devices

- FULOS Fused Disconnecter Loadbreak Switches
- Contact sales office for catalogues

'NHG' General Purpose: Body Size 00C 6A - 100A



Body size 00C

Current rating	Part number	Code	Max voltage rating ac
6A	NHG00C/006	401349	500
10A	NHG00C/010	401350	500
16A	NHG00C/016	401351	500
20A	NHG00C/020	401352	500
25A	NHG00C/025	401353	500
32A	NHG00C/032	401354	500
35A	NHG00C/035	401355	500
40A	NHG00C/040	401356	500
50A	NHG00C/050	401357	500
63A	NHG00C/063	401358	500
80A	NHG00C/080	401359	500
100A	NHG00C/100	401360	500

'NHG' General Purpose: Body Size 00 6A - 160A



Body size 00

Current rating	Part number	Code	Max voltage rating ac
6A	NHG00/006	401335	500
10A	NHG00/010	401336	500
16A	NHG00/016	401337	500
20A	NHG00/020	401338	500
25A	NHG00/025	401339	500
32A	NHG00/032	401340	500
35A	NHG00/035	401341	500
40A	NHG00/040	401342	500
50A	NHG00/050	401343	500
63A	NHG00/063	401344	500
80A	NHG00/080	401345	500
100A	NHG00/100	401346	500
125A	NHG00/125	401347	500
160A	NHG00/160	401348	500

'NHG' General Purpose: Body Size 0 6A - 160A



Body size 0

Current rating	Part number	Code	Max voltage rating ac
6A	NHG0/006	401322	500
10A	NHG0/010	401323	500
16A	NHG0/016	401324	500
20A	NHG0/020	401325	500
25A	NHG0/025	401326	500
32A	NHG0/032	401327	500
35A	NHG0/035	401328	500
40A	NHG0/040	401329	500
50A	NHG0/050	401330	500
63A	NHG0/063	401331	500
100A	NHG0/100	401332	500
125A	NHG0/125	401333	500
160A	NHG0/160	401334	500

'NHG' General Purpose: Body Size 1 40A - 250A



Body size 1

Current rating	Part number	Code	Max voltage rating ac
40A	NHG1/040	401363	500
50A	NHG1/050	401364	500
63A	NHG1/063	401365	500
80A	NHG1/080	401366	500
100A	NHG1/100	401367	500
125A	NHG1/125	401368	500
160A	NHG1/160	401369	500
200A	NHG1/200	401370	500
224A	NHG1/224	401371	500
250A	NHG1/250	401372	500

D



'NHG' General Purpose: Body Size 2 40A - 400A



Body size 2

Current rating	Part number	Code	Max voltage rating ac
40A	NHG2/040	401373	500
50A	NHG2/050	401374	500
63A	NHG2/063	401375	500
80A	NHG2/080	401376	500
100A	NHG2/100	401377	500
125A	NHG2/125	401378	500
160A	NHG2/160	401379	500
200A	NHG2/200	401380	500
224A	NHG2/224	401381	500
250A	NHG2/250	401382	500
315A	NHG2/315	401383	500
355A	NHG2/355	401384	500
400A	NHG2/400	401385	500

'NHG' General Purpose: Body Size 3 315A - 630A



Body size 3

Current rating	Part number	Code	Max voltage rating ac
315A	NHG3/315	401386	500
355A	NHG3/355	401387	500
400A	NHG3/400	401388	500
500A	NHG3/500	401389	500
630A	NHG3/630	401390	500

'NH' DIN Standard

D



‘NHA’ Motor Starting: Body Size 00 6A - 125A



Body size 00

Current rating	Part number	Code	Max voltage rating ac
6A	NHA00/006	401293	500
10A	NHA00/010	401294	500
16A	NHA00/016	401295	500
20A	NHA00/020	401296	500
25A	NHA00/025	401297	500
32A	NHA00/032	401298	500
40A	NHA00/040	401299	500
50A	NHA00/050	401300	500
63A	NHA00/063	401301	500
80A	NHA00/080	401302	500
100A	NHA00/100	401303	500
125A	NHA00/125	401304	500

‘NHA’ Motor Starting: Body Size 0 63A - 160A



Body size 0

Current rating	Part number	Code	Max voltage rating ac
63A	NHA0/063	401290	500
80A	NHA0/080	401291	500
160A	NHA0/160	401292	500

‘NHA’ Motor Starting: Body Size 1 125A - 250A



Body size 1

Current rating	Part number	Code	Max voltage rating ac
125A	NHA1/125	401305	500
160A	NHA1/160	401306	500
200A	NHA1/200	401307	500
250A	NHA1/250	401309	500

‘NHA’ Motor Starting: Body Size 2 125A - 400A



Body size 2

Current rating	Part number	Code	Max voltage rating ac
125A	NHA2/125	401310	500
160A	NHA2/160	401311	500
200A	NHA2/200	401312	500
315A	NHA2/315	401314	500
400A	NHA2/400	401316	500

‘NHA’ Motor Starting: Body Size 3 315A - 630A



Body size 3

Current rating	Part number	Code	Max voltage rating ac
315A	NHA3/315	401317	500
400A	NHA3/400	401319	500
500A	NHA3/500	401320	500
630A	NHA3/630	401321	400

Dimensions in mm

'NHG' and 'NHA'

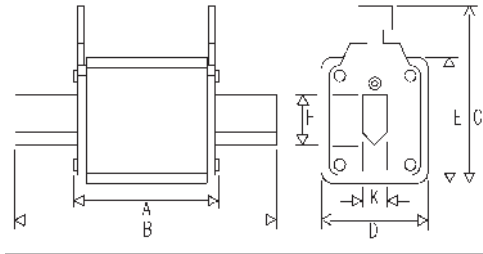

Body size	Rating	A	B	D	E	G	H
00C	6 - 100	54.00	78.00	21.00	41.00	53.00	15.00
00	6 - 160	54.00	78.00	30.00	48.00	60.00	15.00
0	6 - 160	68.00	125.00	30.00	48.00	60.00	15.00
1	40 - 250	75.00	135.00	41.00	53.00	65.00	20.00
2	40 - 400	75.00	150.00	51.00	61.00	73.00	25.00
3	315 - 630	75.00	150.00	72.00	76.00	78.00	32.00

'NH' DIN Standard

D



'NHG' General Purpose: I²t values

6 Amp - 160 Amp

Current Rating (Amp)	Pre-Arcing I ² t (A ² sec)	Total I ² t (A ² sec) at 380 Volt	Total I ² t (A ² sec) at 500 Volt
6	75	120	300
10	250	370	800
16	350	600	1100
20	750	1200	3000
25	1500	2700	5000
32	2000	3500	7000
35	3000	5000	10000
40	4000	6500	15000
50	6000	7000	21000
63	10000	17000	40000
80	15000	30000	60000
100	27000	40000	100000
125	40000	70000	160000
160	80000	120000	350000

200 Amp - 630 Amp

Current Rating (Amp)	Pre-Arcing I ² t (A ² sec x 10 ³)	Total I ² t (A ² sec x 10 ³) at 380 Volt	Total I ² t (A ² sec x 10 ³) at 500 Volt
200	120	200	500
224	180	300	700
250	200	350	800
315	350	600	1300
355	480	700	1700
400	700	1000	2200
500	1000	1800	4000
630	1900	3000	7000

'NHG' General Purpose: Time/current characteristics

6 Amp - 160 Amp

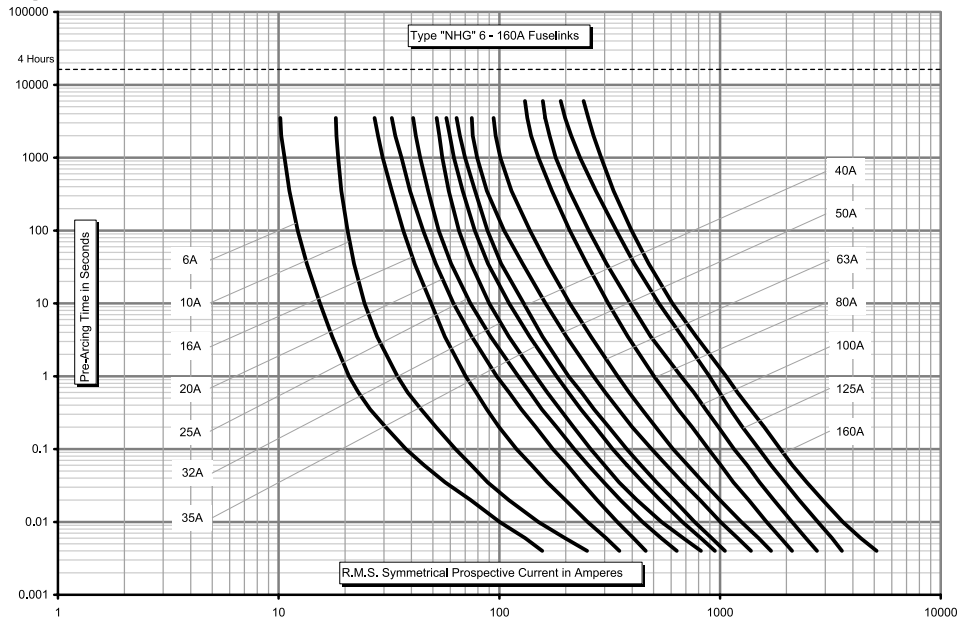

200 Amp - 630 Amp

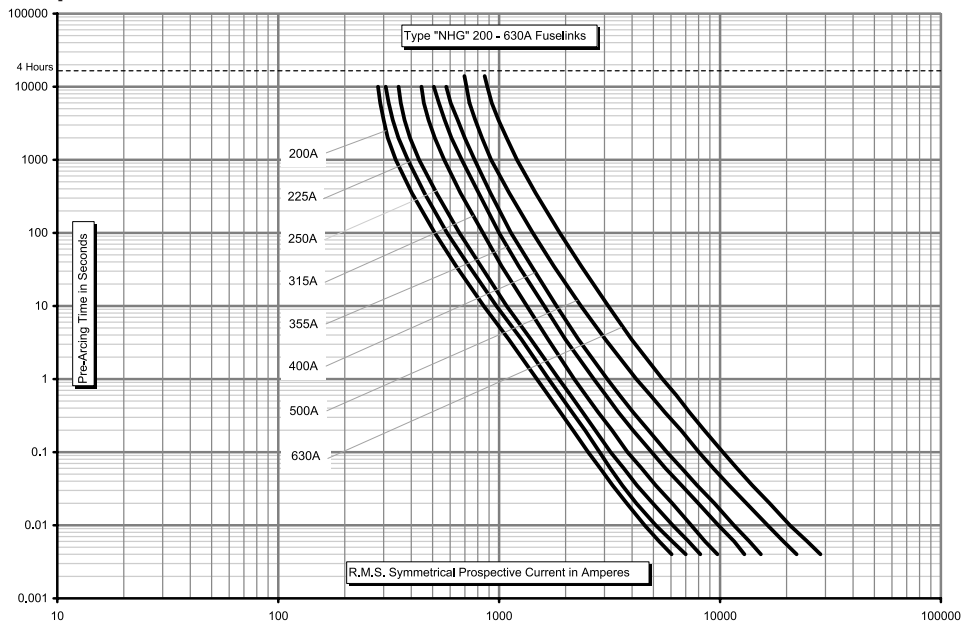

'NHA' Motor Starting: I²t values

6 Amp - 160 Amp

Current Rating (Amp)	Pre-Arcing I ² t (A ² sec)	Total I ² t (A ² sec) at 380 Volt	Total I ² t (A ² sec) at 500 Volt
6	300	400	550
10	500	800	1150
16	800	1200	1800
20	1150	1800	2500
25	1700	2000	3500
32	3000	4500	6500
40	4500	7500	10000
50	7500	10000	15000
63	10000	17000	20000
80	20000	35000	45000
100	40000	60000	80000
125	70000	100000	140000
160	100000	170000	200000

200 Amp - 630 Amp

Current Rating (Amp)	Pre-Arcing I ² t (A ² sec x 10 ³)	Total I ² t (A ² sec x 10 ³) at 380 Volt	Total I ² t (A ² sec x 10 ³) at 500 Volt
200	180	300	400
250	400	500	700
315	450	750	900
400	700	1000	1500
500	1500	2000	3500
630	2100	4000	5000

'NHA' Motor Starting: Time/current characteristics

6 Amp - 160 Amp

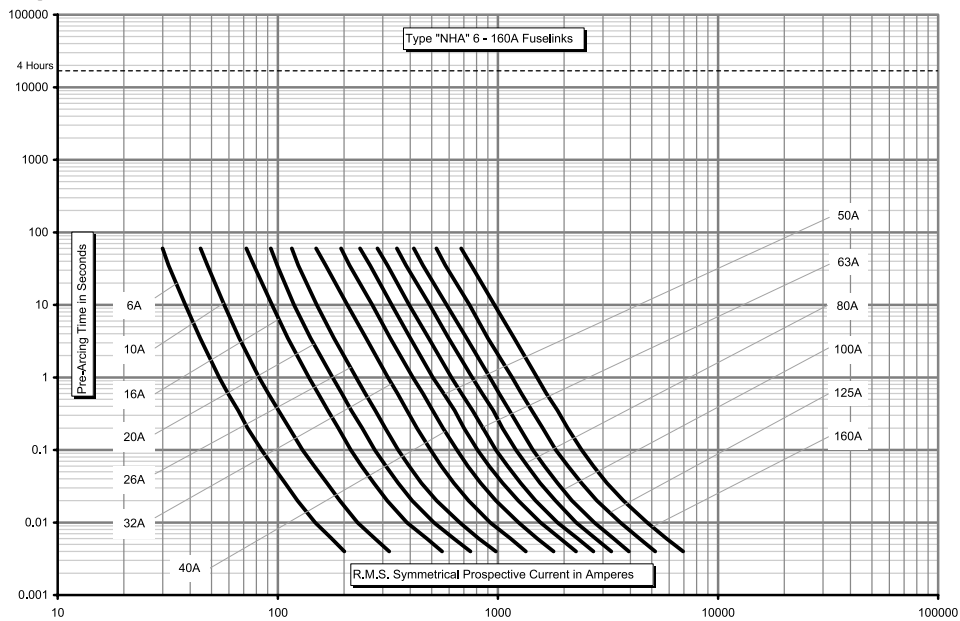

200 Amp - 630 Amp

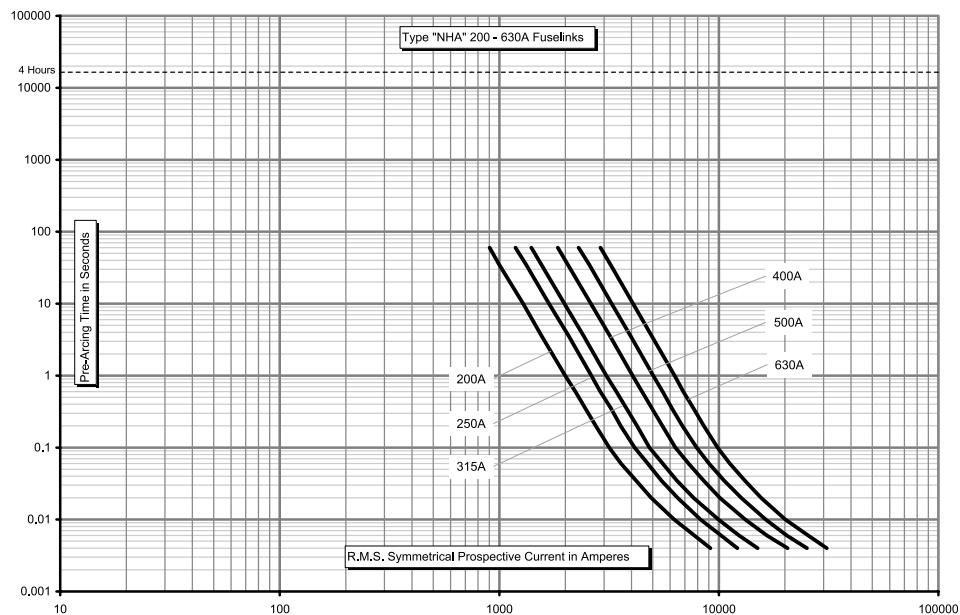

A large grid of graph paper for taking notes, consisting of a 20x30 grid of small squares. The grid is bounded by a solid red line on the top, bottom, and right sides, and a dotted red line on the left side. A large, faint GE logo watermark is visible in the bottom right corner of the grid area.



Contents

RED SPOT Standard A

RED SPOT 400 Series B

SAFECLIP C

'NH' DIN Standard D

Comparative Charts E

- E. 2 – 3 660 Volt ac (RED SPOT Standard)
- E. 4 415 Volt ac (RED SPOT 400 Series)
- E. 5 Blade tag (SAFECLIP)



Comparative chart - 660Vac

RED SPOT Standard - Offset tags: 2-hole fixing

Current Rating	Fixing Centres	BS88 Dim. Ref.	Part Number	Equivalent Bussmann	Equivalent Lawson	Equivalent MEM
2A •	44.5mm	A1	NIT2	NITD2	NIT2	2SA2-550
4A •	44.5mm	A1	NIT4	NITD4	NIT4	4SA2-550
6A •	44.5mm	A1	NIT6	NITD6	NIT6	6SA2-550
10A •	44.5mm	A1	NIT10	NITD10	NIT10	10SA2-550
16A •	44.5mm	A1	NIT16	NITD16	NIT16	16SA2-550
20A •	44.5mm	A1	NIT20	NITD20	NIT20	20SA2-550
25A ◊	44.5mm	-	NET25 *	NITD25	NIT25	25SA2
32A ◊	44.5mm	-	NET32 *	NITD32	NIT32	32SA2
2A	73mm	A2	TIA2	2H07-660	SSA22	2SB3-550 •
4A	73mm	A2	TIA4	4H07-660	SSA24	4SB3-550 •
6A	73mm	A2	TIA6	6H07-660	SSA26	6SB3-550 •
10A	73mm	A2	TIA10	10H07-660	SSA210	10SB3-550 •
16A	73mm	A2	TIA16	16H07-660	SSA216	16SB3-550 •
20A	73mm	A2	TIA20	20H07-660	SSA220	20SB3-550 •
25A	73mm	A2	TIA25	25H07-660	SSA225	25SB3-550 •
32A	73mm	A2	TIA32	32H07-660	SSA232	32SB3-550 •
35A	73mm	A3	TIS35	-	-	-
40A	73mm	A3	TIS40	40K07-660	SSA340	40SB4-550 •
50A	73mm	A3	TIS50	50K07-660	SSA350	50SB4-550 •
63A	73mm	A3	TIS63	63K07-660	SSA363	63SB4-550 •
32A	94mm	A4	TCP32	-	SSA432	-
40A	94mm	A4	TCP40	-	SSA440	-
50A	94mm	A4	TCP50	-	SSA450	-
63A	94mm	A4	TCP63	-	SSA463	-
80A	94mm	A4	TCP80	80L14-660	SSA480	80SD5-550 •
100A	94mm	A4	TCP100	100L14-660	SSA4100	100SD5-550 •
125A	94mm	-	TFP125	125M14-660	SSFP125	125SD6-550 •
160A	94mm	-	TFP160	160M14-660	SSFP160	160SD6-550 •
200A	94mm	-	TFP200	200M14-660	SSFP200	200SD6-550 •

RED SPOT Standard - Central tags: 2-hole fixing

Current Rating	Fixing Centres	BS88 Dim. Ref.	Part Number	Equivalent Bussmann	Equivalent Lawson	Equivalent MEM
80A	111mm	B1	TC80	80L09-660	SSB180	80SF5-550 •
100A	111mm	B1	TC100	100L09-660	SSB1100	100SF5-550 •
125A	111mm	B2	TF125	125M09-660	SSB2125	125SF6-550 •
160A	111mm	B2	TF160	160M09-660	SSB2160	160SF6-550 •
200A	111mm	B2	TF200	200M09-660	SSB2200	200SF6-550 •
250A	111mm	B3	TKF250	250N09-660	SSB3250	250SF7-550 •
315A	111mm	B3	TKF315	315N09-660	SSB3315	315SF7-550 •
250A	133mm	-	TKM250	250N11-660	SSKM250	250SG7-550 •
315A	133mm	-	TKM315	315N11-660	SSKM315	315SG7-550 •
355A	111mm	B4	TMF355	355P09-660	SSB4355	355SF8-550 •
400A	111mm	B4	TMF400	400P09-660	SSB4400	400SF8-550 •

* For use with Switch Fuse Devices, with A1 dimension fixing centres
 • 550Vac
 ◊ 440Vac



Comparative chart - 660Vac

RED SPOT Standard - Central tags: 4-hole fixing

Current Rating	Fixing Centres	BS88 Dim. Ref.	Part Number	Equivalent Bussmann	Equivalent Lawson	Equivalent MEM
355A	133mm	C1	TM355	355P11-660	SSC1355	355SH8-550 •
400A	133mm	C1	TM400	400P11-660	SSC1400	400SH8-550 •
450A	133mm	C2	TTM450	450R11-660	SSC2450	450SH9-550 •
500A	133mm	C2	TTM500	500R11-660	SSC2500	500SH9-550 •
560A	133mm	C2	TTM560	560R11-660	SSC2560	560SH9-550 •
630A	133mm	C2	TTM630	630R11-660	SSC2630	630SH9-550 •
670A	133mm	C3	TLM670	-	SSC3670	-
710A	133mm	C3	TLM710	-	SSC3710	-
750A	133mm	C3	TLM750	-	SSC3750	710SH10-550 •
800A	133mm	C3	TLM800	-	SSC3800	800SH10-550 •
1000A	149mm	D1	TXU1000	-	-	-
1250A	149mm	D1	TXU1250	-	-	-

RED SPOT Standard - Motor circuit protection

Current Rating	Fixing Centres	BS88 Dim. Ref.	Part Number	Equivalent Bussmann	Equivalent Lawson	Equivalent MEM
20M25 ◊	44.5mm	A1	NIT20M25	NITD20M25	NIT20M25	20SA2M25
20M32 ◊	44.5mm	A1	NIT20M32	NITD20M32	NIT20M32	20SA2M32
32M40 ◊	44.5mm	-	NET32M40 *	NITD32M40	-	32SA2M40
32M50 ◊	44.5mm	-	NET32M50 *	NITD32M50	-	32SA2M50
32M63 ◊	44.5mm	-	NET32M63 *	NITD32M63	-	32SA2M63
32M35	73mm	A2	TIA32M35	-	-	-
32M40	73mm	A2	TIA32M40	-	-	-
32M50	73mm	A2	TIA32M50	-	-	-
32M63	73mm	A2	TIA32M63	-	-	-
63M80	73mm	A3	TIS63M80	-	-	-
63M100	73mm	A3	TIS63M100	-	-	-
100M125	94mm	A4	TCP100M125	-	-	-
100M160	94mm	A4	TCP100M160	-	-	-
100M200	94mm	A4	TCP100M200	-	-	-
100M125	111mm	B1	TC100M125	-	-	-
100M160	111mm	B1	TC100M160	-	-	-
100M200	111mm	B1	TC100M200	-	-	-
200M250	111mm	B2	TF200M250	-	-	-
200M315 •	111mm	B2	TF200M315	-	-	-
315M355	111mm	B3	TKF315M355	-	-	-
400M450	111mm	B4	TMF400M450	-	-	-
400M450	133mm	C1	TM400M450	-	-	-
630M670	133mm	C2	TTM630M670	-	-	-

- * For use with Switch Fuse Devices, with A1 dimension fixing centres
- 550Vac
- ◊ 440Vac

Note: The comparative types listed are a guide to interchangeability. There are some minor dimensional differences between manufacturers. The above cross-reference chart is based on comparable voltage and current ratings. It is essential that other performance characteristics are checked to ensure compatibility.

Comparative chart - 415Vac

RED SPOT 400 Series - Offset tags: 2-hole fixing

Current Rating	Fixing Centres	BS88 Dim. Ref.	Part Number	Equivalent Bussmann	Equivalent Lawson	Equivalent MEM
2A	44.5mm	A1	GNIT2 ◊	NITD2	NIT2	2SA2
4A	44.5mm	A1	GNIT4 ◊	NITD4	NIT4	4SA2
6A	44.5mm	A1	GNIT6 ◊	NITD6	NIT6	6SA2
10A	44.5mm	A1	GNIT10 ◊	NITD10	NIT10	10SA2
16A	44.5mm	A1	GNIT16 ◊	NITD16	NIT16	16SA2
20A	44.5mm	A1	GNIT20 ◊	NITD20	NIT20	20SA2
2A	73mm	A2	GTIA2 ◊	AAO2	TIA2	2SB3
4A	73mm	A2	GTIA4 ◊	AAO4	TIA4	4SB3
6A	73mm	A2	GTIA6 ◊	AAO6	TIA6	6SB3
10A	73mm	A2	GTIA10 ◊	AAO10	TIA10	10SB3
16A	73mm	A2	GTIA16 ◊	AAO16	TIA16	16SB3
20A	73mm	A2	GTIA20 ◊	AAO20	TIA20	20SB3
25A	73mm	A2	GTIA25 ◊	AAO25	TIA25	25SB3
32A	73mm	A2	GTIA32 ◊	AAO32	TIA32	32SB3
35A	73mm	A3	GTIS35 ◊	-	-	35SB4
40A	73mm	A3	GTIS40 ◊	BAO40	TIS40	40SB4
50A	73mm	A3	GTIS50 ◊	BAO50	TIS50	50SB4
63A	73mm	A3	GTIS63 ◊	BAO63	TIS63	63SB4
35A	94mm	A4	GTCP35 ◊	CEO32	TCP32	32SD5
40A	94mm	A4	GTCP40 ◊	CEO40	TCP40	40SD5
50A	94mm	A4	GTCP50 ◊	CEO50	TCP50	50SD5
63A	94mm	A4	GTCP63 ◊	CEO63	TCP63	63SD5
80A	94mm	A4	GTCP80 ◊	CEO80	TCP80	80SD5
100A	94mm	A4	GTCP100 ◊	CEO100	TCP100	100SD5
125A	94mm	-	GTFP125 ◊	DEO125	TFP125	125SD6
160A	94mm	-	GTFP160 ◊	DEO160	TFP160	160SD6
200A	94mm	-	GTFP200 ◊	DEO200	TFP200	200SD6

RED SPOT 400 Series - Central tags: 2-hole fixing

Current Rating	Fixing Centres	BS88 Dim. Ref.	Part Number	Equivalent Bussmann	Equivalent Lawson	Equivalent MEM
125A	111mm	B2	GTF125 ◊	DD125	TF125	125SF6
160A	111mm	B2	GTF160 ◊	DD160	TF160	160SF6
200A	111mm	B2	GTF200 ◊	DD200	TF200	200SF6
250A	111mm	B3	GTKF250	ED250	TKF250	250SF7
315A	111mm	B3	GTKF315	ED315	TKF315	315SF7
250A	133mm	-	GTKM250	EFS250	TKM250	250SG7
315A	133mm	-	GTKM315	EFS315	TKM315	315SG7
355A	111mm	B4	GTMF355	ED355	TMF355	355SF8
400A	111mm	B4	GTMF400	ED400	TMF400	400SF8

RED SPOT 400 Series - Central tags: 4-hole fixing

Current Rating	Fixing Centres	BS88 Dim. Ref.	Part Number	Equivalent Bussmann	Equivalent Lawson	Equivalent MEM
355A	133mm	C1	GTM355	EF355	TM355	355SH8
400A	133mm	C1	GTM400	EF400	TM400	400SH8

◊ 440Vac

Note: The comparative types listed are a guide to interchangeability. There are some minor dimensional differences between manufacturers. The above cross-reference chart is based on comparable voltage and current ratings. It is essential that other performance characteristics are checked to ensure compatibility.



Comparative chart - Blade tag

SAFECLIP - Offset blade tag

Current Rating	Max Voltage Rating ac	BS88 Dim. Ref.	Part Number	Equivalent Bussmann	Equivalent Lawson	Equivalent MEM
2A	240	E1	SS2	SSD2	SS2	2SS
4A	240	E1	SS4	SSD4	SS4	4SS
6A	240	E1	SS6	SSD6	SS6	6SS
10A	240	E1	SS10	SSD10	SS10	10SS
16A	240	E1	SS16	SSD16	SS16	15SS
20A	240	E1	SS20	SSD20	SS20	20SS
2A	440	F1	NS2	NSD2	NS2	2SN2
4A	440	F1	NS4	NSD4	NS4	4SN2
6A	440	F1	NS6	NSD6	NS6	6SN2
10A	440	F1	NS10	NSD10	NS10	10SN2
16A	440	F1	NS16	NSD16	NS16	16SN2
20A	440	F1	NS20	NSD20	NS20	20SN2
25A	440	F1	NS25	NSD25	NS25	25SN2
32A	440	F1	NS32	NSD32	NS32	32SN2
40A	440	F2	ES40	ESD40	MES40	40SP
50A	440	F2	ES50	ESD50	MES50	50SP
63A	440	F2	ES63	ESD63	MES63	63SP
2A	440	-	XS2	-	-	-
4A	440	-	XS4	-	-	-
6A	440	-	XS6	-	-	-
10A	440	-	XS10	-	-	-
16A	440	-	XS16	-	-	-
20A	440	-	XS20	-	-	-
25A	440	-	XS25	-	-	-
32A	440	-	XS32	-	-	-
35A	440	-	XS35	-	-	-
40A	440	-	XS40	-	-	-
50A	440	-	XS50	-	-	-
63A	440	-	XS63	-	-	-
80A	440	-	XS80	-	-	-
100A	440	-	XS100	-	-	-
125A	415	-	XS125	-	-	-

SAFECLIP - Offset tags: 2-hole fixing: Type OS

Current Rating	Max Voltage Rating ac	BS88 Dim. Ref.	Part Number	Equivalent Bussmann	Equivalent Lawson	Equivalent MEM
80A	440	-	OS80 **	OSD80	TIS80	80SO
100A	440	-	OS100 **	OSD100	TIS100	100SO

SAFECLIP - Motor circuit protection

Current Rating	Max Voltage Rating ac	BS88 Dim. Ref.	Part Number	Equivalent Bussmann	Equivalent Lawson	Equivalent MEM
32M40	415	-	NS32M40	NSD32M40	NS32M40	32SN2M40
63M80	415	-	ES63M80	ESD63M80	-	-
100M125	415	-	OS100M125 **	OSD100M125	TIS100M125	100SOM125
100M160	415	-	OS100M160 **	OSD100M160	-	100SOM160

** Bolted tag Fuse Link (BS88 Part 2. A3 dimension fixing centres).

Note: The comparative types listed are a guide to interchangeability. There are some minor dimensional differences between manufacturers. The above cross-reference chart is based on comparable voltage and current ratings. It is essential that other performance characteristics are checked to ensure compatibility.





We bring good things to life.

GE Power Controls in Europe

GE Power Controls is the European arm of GE Industrial Systems, one of the ten core businesses of the General Electric Company (USA), known internationally for its positive approach to its customers, its people and the world we all live in.

GE Power Controls is a top class European supplier of low-voltage products including wiring devices, residential and industrial electrical distribution components, general purpose control products, enclosures and switchboards. Most of the global demand for the company's products comes from OEMs, wholesalers, installers and panel-board builders worldwide.

So, these are the facts, now the story behind them. GE Power Controls' name is synonymous with technical expertise, quality of products and services, and the broadness of its range. But this is not enough, in a constantly changing and competitive environment we have to offer all this and more. Over the next few years our product range will be dramatically expanded and renewed .

The goal we have set for quality ensures no less than constant progress, as part of GE's company-wide Six Sigma product and service excellence initiative. This applies not only to our products and services but also to our business conduct, where only the highest standards are good enough. We believe that our most important asset is the trust our customers put in us. We earn it by our continuing quest for improvement on every front and our strong commitment to integrity and reliability.

GE Power Controls

Now on the net !
www.gpowercontrols.com

GE POWER CONTROLS

Hornhouse Lane
Knowsley Business Park
Liverpool L33 7YQ

T 0870 600 4372
F 0151 549 4546
E gepcuk@gepc.ge.com